



Resistance thermometer

- With transmitter
- Wide range of applications for neutral mediums and aggressive fluids



Product variants described in the data sheet may differ from the product presentation and description.

Type description

Temperature measuring with 1xPt100-temperature probe integrated in stainless steel tube; Measuring unit according DIN IEC 751 welded-in and not exchangeable.



Table of contents

1. General technical data	3
2. Dimensions	3
3. Ordering information	4
3.1. Bürkert eShop – Easy ordering and quick delivery.....	4
3.2. Bürkert product filter.....	4
3.3. Ordering chart.....	4
3.4. Ordering chart accessories.....	4

DTS 1000110274 EN Version: E Status: RL (released | freigegeben | validé) printed: 30.10.2019

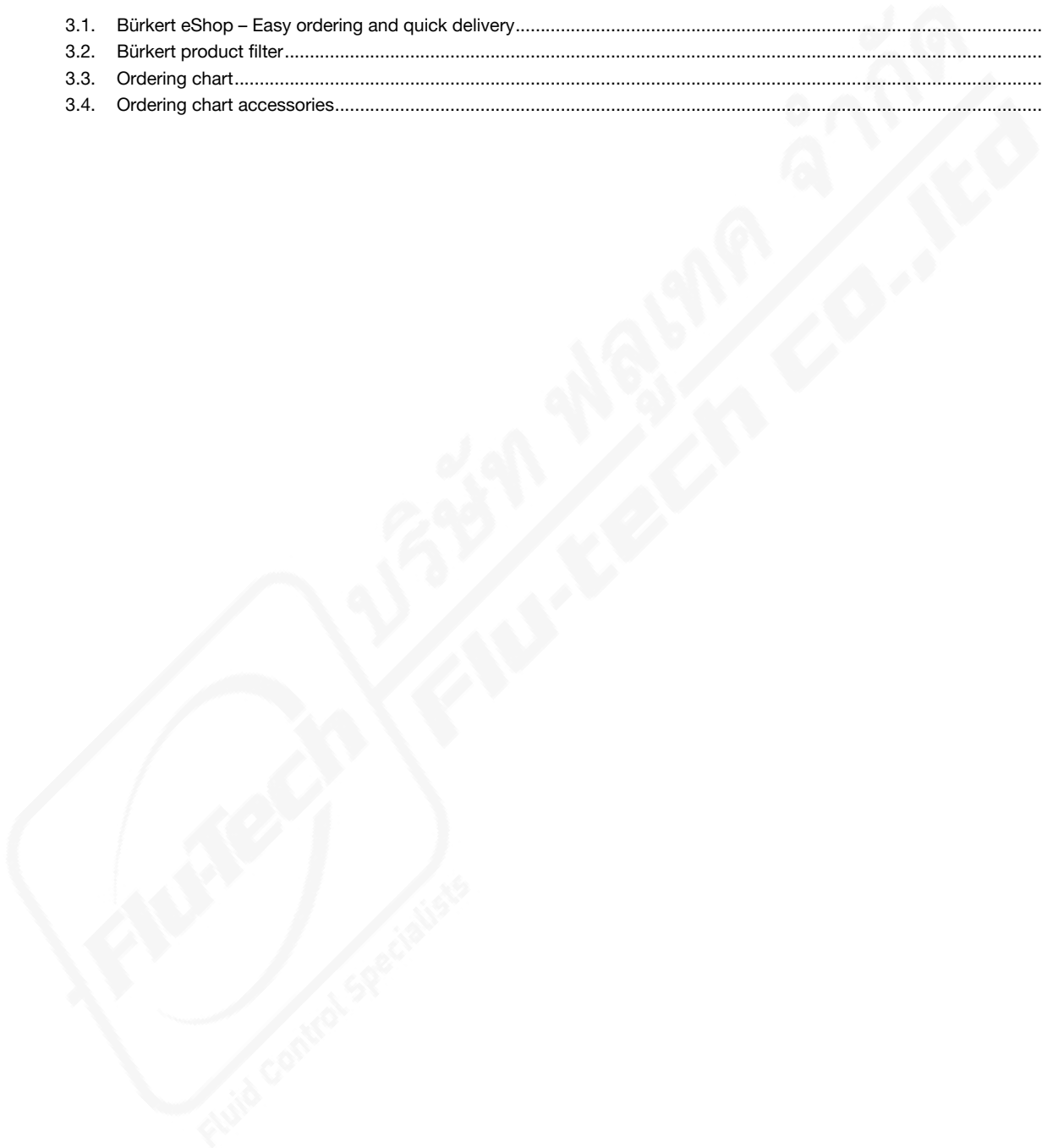

1. General technical data

Product properties	
Dimensions	Detailed information can be found in chapter "2. Dimensions" on page 3.
Material	
Protection tube material	Stainless steel 1.4571
Circuit type	2-wire circuit
Connection	External thread G ½ A
Electrical data	
Output signal	4 up to 20 mA (correspond from 0 up to +150 °C)
Measuring current	Approx. 1 mA (film measuring resistor)
Performance data	
Measuring range	0 up to +150 °C
Accuracy	Class B (ΔT [degree]= $\pm 0.3 \pm 0.005 T$ [°C])
Approvals and certificates	
Protection class	IP67 with connector
Product connections	
Electrical connections	Lumberg connector with/without cable
Environment and installation	
Ambient temperature	Max. +85 °C

2. Dimensions

Note:

Dimensions in mm

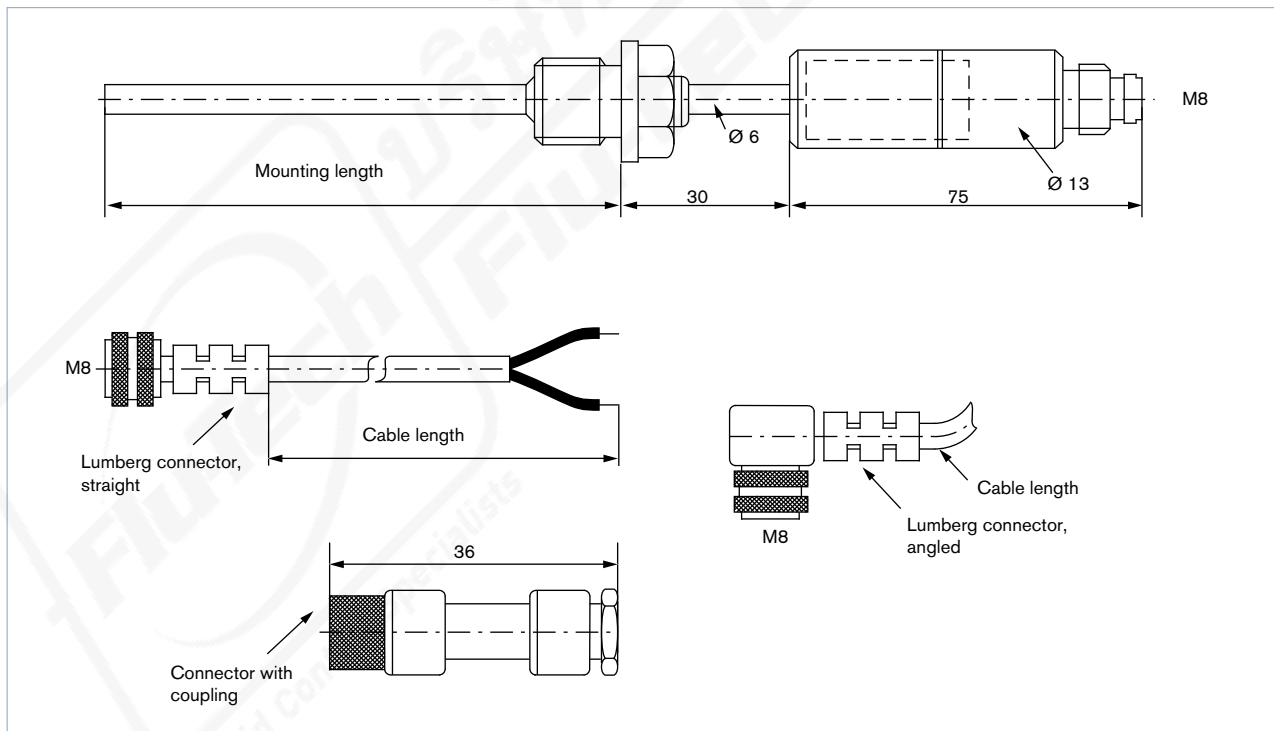

3. Ordering information

3.1. Bürkert eShop – Easy ordering and quick delivery



Bürkert eShop – Easy ordering and fast delivery

You want to find your desired Bürkert product or spare part quickly and order directly? Our online shop is available for you 24/7. Sign up and enjoy all the benefits.

[Order online now](#)

3.2. Bürkert product filter

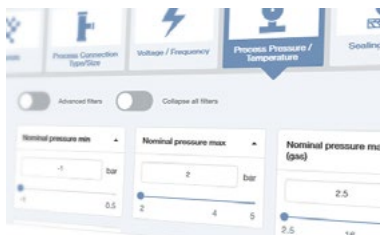



Bürkert product filter – Get quickly to the right product





You want to select products comfortably based on your technical requirements? Use the Bürkert product filter and find suitable articles for your application quickly and easily.

[Try out our product filter](#)

3.3. Ordering chart

Mounting length [mm]	Thread	Article no.
40	G ½	784334 
50	G ½	784335 

3.4. Ordering chart accessories

Round connector, 4-pins, Lumberg	Cable length	Article no.
Straight	2 m	784337 
Straight	5 m	784338 
Angled	2 m	784339 
Angled	5 m	784340 
Connector with coupling	–	784336 