



## Radar level meter for higher pressure ranges

- For level measurement up to 35 m
- 4...20 mA/Hart, 2 wires
- Adjustable with display/configuration module or PC
- ATEX approvals

Product variants described in the data sheet may differ from the product presentation and description.

### Can be combined with



**Type 8635** ▶  
Digital electropneumatic Positioner SideControl



**Type 8692** ▶  
Digital electropneumatic Positioner for the integrated mounting on process control valves



**Type 8644** ▶  
Remote Process Actuation Control System AirLINE

### Type description

Type 8137 is a non-contact radar level meter for continuous level measurement.

The unit is available in two variants:

- with thread and horn antenna (ø 40 mm).  
Particularly suitable for use in small tanks and process vessels for the level measurement of practically any product.
- with flange and horn antenna (ø 40 or 75 mm).  
Particularly suitable for use in storage tanks and process vessels for the level measurement of products such as solvents, hydrocarbons and fuels under extremely difficult process conditions.



## Table of contents

<b>1. General technical data</b>	<b>3</b>
<b>2. Approvals</b>	<b>5</b>
2.1. ATEX-Certification.....	5
<b>3. Materials</b>	<b>5</b>
3.1. Chemical Resistance Chart – Bürkert resistApp.....	5
<b>4. Dimensions</b>	<b>6</b>
4.1. Version with thread horn antenna.....	6
4.2. Version with flange horn antenna.....	7
<b>5. Performance specifications</b>	<b>8</b>
5.1. Measurement deviation diagram .....	8
<b>6. Product operation</b>	<b>8</b>
6.1. Measuring principle .....	8
6.2. Product operation notes .....	9
Operating techniques.....	9
Set up with display/configuration module .....	9
Set up with PACTware™/DTM and HART communication.....	9
<b>7. Ordering information</b>	<b>10</b>
7.1. Bürkert eShop – Easy ordering and quick delivery.....	10
7.2. Bürkert product filter.....	10
7.3. Ordering chart.....	10
7.4. Ordering chart accessories.....	11

## 1. General technical data

### Product properties

#### Material

Please make sure the device materials are compatible with the fluid you are using.

Detailed information can be found in chapter [“3.1. Chemical Resistance Chart – Bürkert resistApp” on page 5.](#)

#### Non wetted parts

Housing	PBT, Stainless steel 316L (1.4404)
Cover	PC transparent
Seal between housing and cover	EPDM
Cable gland	PA
Blind plug	PA
Ground terminal	Stainless steel 316Ti/316L (1.4571/1.4435)

#### Wetted parts

Process connection	Stainless steel 316L
Process seal	NBR with aramid fibres for device with thread process connection (for others versions not included in the delivery)
Antenna	Stainless steel 316L
Antenna cone	PTFE (TFM 1600 PTFE)
Seal	Antenna system: FKM
Dimensions	Detailed information can be found in chapter <a href="#">“4. Dimensions” on page 6.</a>
Weights	2...17.2 kg (depending on process connection and antenna)
Measuring variable	Distance between the end of the level meter antenna and the product surface. Detailed information can be found in chapters <a href="#">“5.1. Measurement deviation diagram” on page 8</a> and <a href="#">“6.1. Measuring principle” on page 8.</a>
Measuring range	Max. 35 m Recommended measuring range: <ul style="list-style-type: none"> <li>• 0.05...15 m (recommended, with antenna Ø 40 mm)</li> <li>• 0.05...35 m (recommended, with antenna Ø 75 mm)</li> </ul>
Beam angle <sup>1)</sup>	<ul style="list-style-type: none"> <li>• 20° with antenna Ø 40 mm</li> <li>• 10° with antenna Ø 75 mm</li> </ul>
Damping (63% of the input value)	0...999 s, adjustable
Step response time <sup>2)</sup>	≤3 s

#### Product accessories

Display	LCD in full dot matrix (optional, must be ordered separately). Detailed information can be found in chapter <a href="#">“7.4. Ordering chart accessories” on page 11.</a>
---------	---

### Performance data

Measurement deviation	±2 mm (measuring distance >0.5 m) Detailed information can be found in chapter <a href="#">“5.1. Measurement deviation diagram” on page 8.</a>
Measuring range resolution	1 mm
Measuring frequency	K-Band (26 GHz technology)
Measuring cycle time	Approx. 450 ms
Temperature drift	<ul style="list-style-type: none"> <li>• Digital output: ±3 mm/10 K, max. 10 mm</li> <li>• Current output: &lt;0.03%/10K relating to the 16 mA span or ≤0.3 %</li> </ul>
Non-repeatability <sup>3)</sup>	≤1 mm
Vibration resistance	4 g with 5...200 Hz according to EN 60068-2-6 (vibration at resonance)
Shock resistance	100 g, 6 ms according to EN 60068-2-27 (mechanical shock)

### Electrical data

Operating voltage (U <sub>n</sub> )	<ul style="list-style-type: none"> <li>• Without display/configuration module: <ul style="list-style-type: none"> <li>– 9.6...35 V DC</li> <li>– 9.6...30 V DC (Ex ia instrument)</li> </ul> </li> <li>• With display/configuration module: <ul style="list-style-type: none"> <li>– 16...35 V DC</li> <li>– 16...30 V DC (Ex ia instrument)</li> </ul> </li> </ul>
Power Source (not supplied)	Limited power source according to UL/EN 60950-1 standards or limited energy circuit according to UL/EN 61010-1 §9.4
Starting current	≤3.6 mA; ≤10 mA for 5 ms after switching on

DC reverse polarity protection	Yes
Output signal	4...20 mA/HART
Signal resolution	0.3 $\mu$ A
Range of the output signal	3.8...20.5 mA/HART (default setting)
Load resistor	$(U_n - U_{min.})/0.022$ A
Fault signal	Current output: mA value unchanged, 20.5 mA, 22 mA or <3.6 mA (adjustable)
Max. output current	22 mA
Residual ripple (at DC)	<ul style="list-style-type: none"> <li>For <math>9.6\text{ V} &lt; U_n &lt; 18\text{ V}</math>: <math>\leq 0.7 V_{eff}</math> (16...400 Hz)</li> <li>For <math>18\text{ V} &lt; U_n &lt; 35\text{ V}</math>: <math>\leq 1.0 V_{eff}</math> (16...400 Hz)</li> </ul>
Voltage supply cable	<ul style="list-style-type: none"> <li>Cable diameter: 5...9 mm</li> <li>Wire cross-section (spring-loaded terminals): <ul style="list-style-type: none"> <li>– massive wire, stranded wire: 0.2...2.5 mm<sup>2</sup> (AWG 24...14)</li> <li>– stranded wire with end sleeve: 0.2...1.5 mm<sup>2</sup> (AWG 24...16)</li> </ul> </li> </ul>

**Medium data**

Process temperature	-40 °C...+130 °C (-40 °F...266 °F)
Process pressure	Vessel pressure: -1...40 bar (-100...4000 kPa/-14.5...580 psi) or according to flange rules
Dielectric constant (min.)	$\epsilon_r > 1.6$

**Process/Port connection & communication**

Process connection	<ul style="list-style-type: none"> <li>Thread G 1½" or NPT 1½"</li> <li>Flange DN 50 or DN 100 DIN 2501, 2" or 4" ANSI B16.5</li> </ul>
Electrical connection	Cable glands M20x1.5

**Approvals and Certificates****Standards**

Degree of protection according to IEC/EN 60529	IP66/IP67 with M20x1.5 gland mounted and tightened
Overvoltage category according to IEC 61010-1	Category III
Protection class according to IEC 61010-1	Class III

**Directives**

CE directives	The applied standards, which verify conformity with the EU Directives, can be found on the EU Type Examination Certificate and/or the EU Declaration of conformity (if applicable)
NAMUR recommendations	<ul style="list-style-type: none"> <li>NE21 – Electromagnetic compatibility of equipment</li> <li>NE43 – Signal level for fault information from measuring transducers</li> <li>NE53 – Compatibility of field devices and display/adjustment components</li> <li>NE107 – Self-monitoring and diagnosis of field devices</li> </ul>

**Approvals**

ATEX	EN 60079-0, EN 60079-11, EN 60079-26 Detailed information can be found in chapter <b>"2.1. ATEX-Certification"</b> on page 5.
------	--

**Environment and installation**

Ambient temperature	Operation and storage: -40 °C...+80 °C (-40 °F...+176 °F)
Relative air humidity	20...85 %, without condensation
Height above sea level	<ul style="list-style-type: none"> <li>By default: max. 2000 m</li> <li>With connected overvoltage protection: max. 5000 m</li> </ul>
Pollution degree	Degree 4 (when used with fulfilled housing protection)

- 1.) Outside the specified beam angle, the energy level of the radar signal is 50 % (-3 dB) less
- 2.) Time span after a sudden measuring distance change by max. 0.5 m in liquid applications, max 2 m with bulk solids applications, until the output signal has taken for the first time 90 % of the final value (IEC 61298-2)
- 3.) Already included in the measuring deviation

## 2. Approvals

### 2.1. ATEX-Certification

**Note:**

Devices with Ex certification have different technical data, see **Supplement ATEX Type 8137** ▶ under user manual.

Certificate	Description
	<p><b>EU-Type Examination Certificate Number:</b> PTB 08 ATEX 2002X</p> <p><b>ATEX</b></p> <ul style="list-style-type: none"> <li>• II 1/2G Ex ia IIC T6 Ga/Gb</li> <li>• II 2G Ex ia IIC T6 Gb</li> </ul> <p>Measures to comply with ATEX requirements: refer to the <b>Supplement ATEX Type 8137</b> ▶ under user manual. The Ex. certification is only valid if the Bürkert device is used as described in the supplement ATEX. If unauthorized changes are made to the device, the Ex. certification becomes invalid.</p>

## 3. Materials

### 3.1. Chemical Resistance Chart – Bürkert resistApp

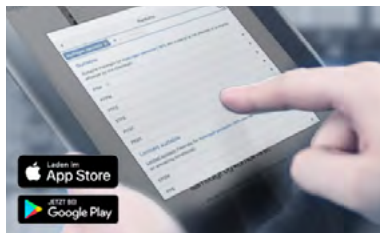

#### Bürkert resistApp – Chemical Resistance Chart

You want to ensure the reliability and durability of the materials in your individual application case? Verify your combination of media and materials on our website or in our resistApp.

[Start Chemical Resistance Check](#)

## 4. Dimensions

### 4.1. Version with thread horn antenna

**Note:**

Dimensions in mm

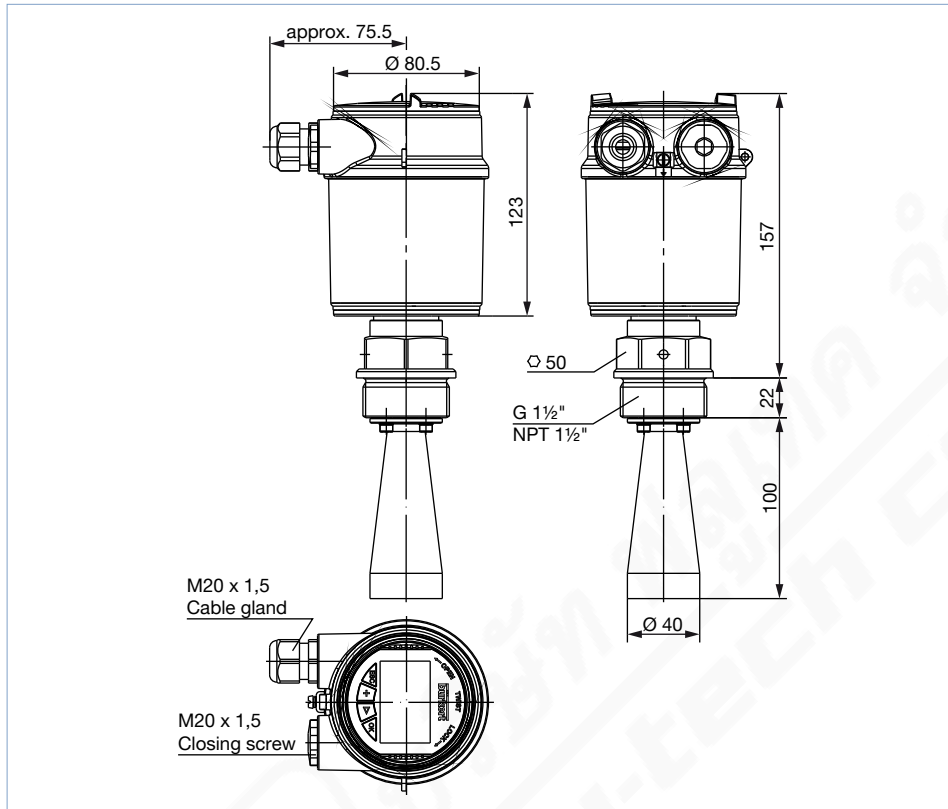

### 4.2. Version with flange horn antenna

**Note:**

Dimensions in mm

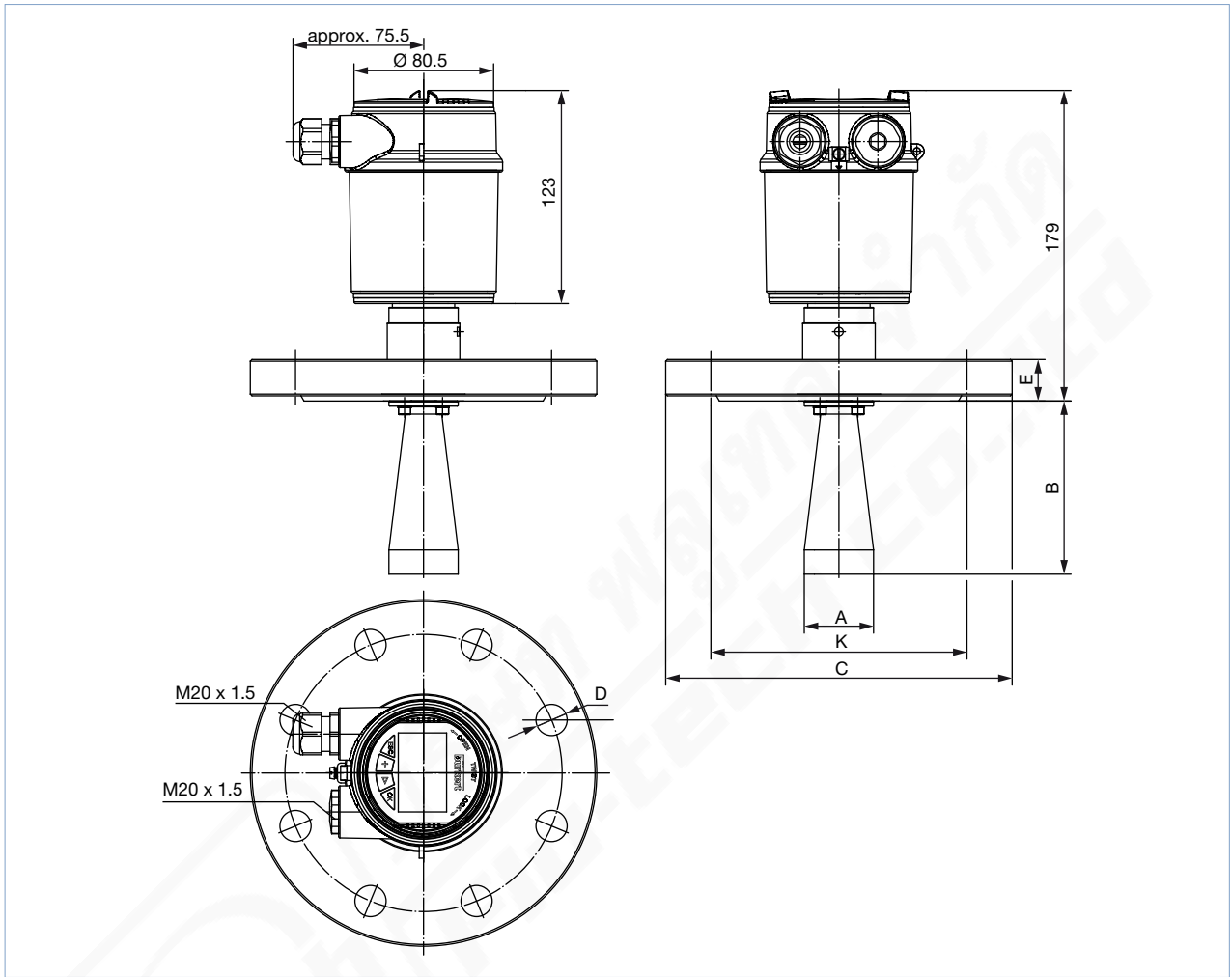

Standard	DN	A	B	C	E	D	K
DIN 2501	50	Ø 40	100	Ø 165	20	4 x Ø 18	Ø 125
DIN 2501	100	Ø 75	216	Ø 220	20	8 x Ø 18	Ø 180
ANSI B16.5	2"	Ø 40	100	Ø 152.4	19.1	4 x Ø 19.1	Ø 120.7
ANSI B16.5	4"	Ø 75	216	Ø 228.6	23.9	8 x Ø 19.1	Ø 190.5

DTS 1000105438 EN Version: M Status: RL (released | freigegeben | valide) printed: 15.09.2021

## 5. Performance specifications

### 5.1. Measurement deviation diagram

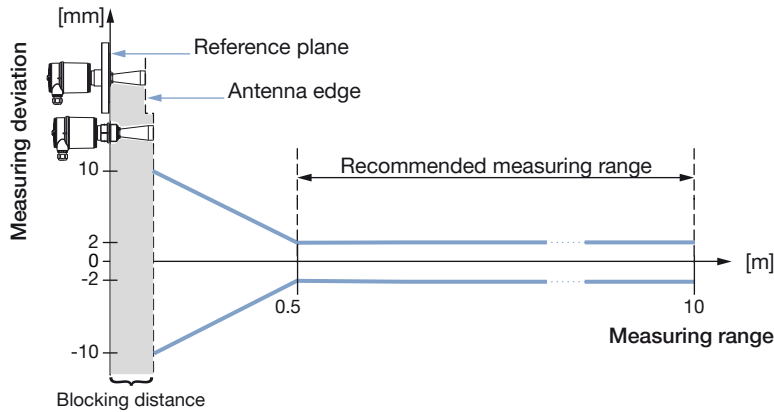

## 6. Product operation

### 6.1. Measuring principle

The radar measuring device consists of an electronic housing, a process connection element with antenna and a sensor. The antenna emits short radar pulses with a duration of approximate 1 ns to the medium. These pulses are reflected by the medium surface and received by the antenna as echoes. Radar waves travel at the speed of light. The running time of the radar pulses from emission to reception is proportional to the distance and hence to the level. The determined level is converted into an output signal and transmitted as a measured value.

The measuring range of the radar level measuring device begins physically at the end of the antenna. However, the min./max. adjustment begins at the reference plane. The position of the reference plane depends on the sensor version.

- Version with thread and horn antenna: the reference plane is the sealing surface on the hexagon.
- Version with flange and horn antenna: the reference plane is the lower side of the flange.

Version with thread and horn antenna

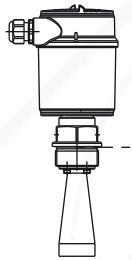

Version with flange and horn antenna

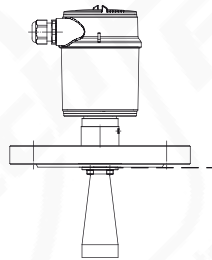

----- Reference plane



## 6.2. Product operation notes

### Operating techniques

The measuring device provides different operating techniques:

- the display/configuration module
- the suitable Bürkert DTM in conjunction with adjustment software according to the FDT/DTM standard, e.g. PACTware™ and PC
- a HART handheld

The entered parameters are generally saved in the measuring device Type 8137. Optionally, parameters may also be uploaded and downloaded with the display/configuration module or saved in a file by using PACTware™/8137-DTM.

### Set up with display/configuration module

Display/configuration module	Description
	The display/configuration module can be inserted into the measuring device and removed again at any time. It is not necessary to interrupt the power supply. The measuring device is adjusted via the four keys of the display/configuration module.

### Set up with PACTware™/DTM and HART communication

Assembly	Description								
	The measuring device can be operated thanks to PACTware™, via HART communication. An interface adapter is necessary for the adjustment with PACTware™. For the setup of the Type 8137, the DTM in the actual version must be used. The basic version of DTM incl. PACTware™ is available as a free-of-charge download from the internet at <a href="http://www.burkert.com">www.burkert.com</a> ▶.								
<b>Connecting the PC via HART</b>									
<table border="1"> <thead> <tr> <th>No.</th> <th>Description</th> </tr> </thead> <tbody> <tr> <td>1</td> <td>Measuring device Type 8137</td> </tr> <tr> <td>2</td> <td>HART-USB Modem</td> </tr> <tr> <td>3</td> <td>Resistance 250 Ω</td> </tr> </tbody> </table>	No.	Description	1	Measuring device Type 8137	2	HART-USB Modem	3	Resistance 250 Ω	
No.	Description								
1	Measuring device Type 8137								
2	HART-USB Modem								
3	Resistance 250 Ω								
Necessary components: <ul style="list-style-type: none"> <li>• Measuring device Type 8137</li> <li>• PC with PACTware™ and suitable Bürkert DTM</li> <li>• HART-USB Modem</li> <li>• Resistance approx. 250 Ω</li> <li>• Power supply unit</li> </ul>									

DTS 1000105438 EN Version: M Status: RL (released | freigegeben | valide) printed: 15.09.2021

## 7. Ordering information

### 7.1. Bürkert eShop – Easy ordering and quick delivery



**Bürkert eShop – Easy ordering and fast delivery**

You want to find your desired Bürkert product or spare part quickly and order directly? Our online shop is available for you 24/7. Sign up and enjoy all the benefits.

[Order online now](#)

### 7.2. Bürkert product filter



**Bürkert product filter – Get quickly to the right product**

You want to select products comfortably based on your technical requirements? Use the Bürkert product filter and find suitable articles for your application quickly and easily.





[Try out our product filter](#)

### 7.3. Ordering chart



**Note:**

All following versions are supplied without display/configuration module.

Operating voltage	Output	Antenna version	Process connection	Electrical connection	Article no.
<b>Standard version</b>					
9.6...35 V DC	4...20 mA/HART (2 wires)	Ø 40 mm	G 1½	Cable gland M20 x 1.5	560157
			NPT 1½		560159
			Flange DN 50 DIN 2501/40 bar		560161
			Flange 2" ANSI B16.5/150 lb RF		560163
		Ø 75 mm	Flange DN 100 DIN 2501/40 bar		560165
			Flange 4" ANSI B16.5/150 lb RF		560167
<b>Ex version – ATEX approval</b>					
9.6...30 V DC	4...20 mA/HART (2 wires)	Ø 40 mm	G 1½	Cable gland M20 x 1.5	560158
			NPT 1½		560160
			Flange DN 50 DIN 2501/16 bar		560162
			Flange 2" ANSI B16.5/150 lb RF		560164
		Ø 75 mm	Flange DN 100 DIN 2501/40 bar		560166
			Flange 4" ANSI B16.5/150 lb RF		560168

Further versions on request	
 <b>Process connection</b> Flange: <ul style="list-style-type: none"> <li>• DN 80 PN 40 Form C DIN 2501</li> <li>• DN 150 PN 40 Form C DIN 2501</li> <li>• DN 200 PN 40 Form C DIN 2501</li> <li>• 3" 150 lb RF; ANSI B16.5</li> <li>• 6" 150 lb RF; ANSI B16.5</li> <li>• 8" 150 lb RF; ANSI B16.5</li> </ul>	 <b>Additional</b> Antenna Ø 48 mm, 95 mm
 <b>Temperature</b> Up to +450 °C	 <b>Pressure</b> Up to 160 bar (16000 kPa)

#### 7.4. Ordering chart accessories

Description	Article no.
Set with 2 reductions M20x1.5/NPT½ + 2 neoprene flat seals for cable gland + 2 screw-plugs M20 x 1.5	551782 
Hart-USB Modem	560177 
Set with a display/configuration module, a transparent cover and a seal ring	559279 
Set with a transparent cover and a seal ring	561006 