



Oval rotor low flow sensor

- For highly viscous fluids
- Value indication, monitoring, transmitting, On/Off control and batch control in combination with different transmitters

Product variants described in the data sheet may differ from the product presentation and description.

Can be combined with

- | | |
|--|---|
| | Type 8025 ▶
Insertion flowmeter/batch controller with paddle wheel and flow transmitter/remote batch controller |
| | Type 8692 ▶
Digital electro-pneumatic positioner for integrated mounting on process control valves |
| | Type 8619 ▶
multiCELL - Multi-channel and multi-function transmitter/controller |

Type description

This sensor is specially designed for measurement or batch control of highly viscous fluids like glue, honey or oil. It allows an easy connection to transmitters like Type 8025 or Type 8619 for more functionality.

The design of this low flow sensor is based on the oval rotor principle. This has proven to be a reliable and highly accurate volumetric method of measuring flow. Exceptional repeatability and high accuracy over a wide range of viscosities and flowrates are features of this design.

The low pressure drop and high pressure rating make it suitable for gravity and pump (in-line) applications and many others.

All sensors provide Open Collector NPN frequency output and frequency output on Reed contact via 1-meter 5-wire cable.



Table of contents

1. General technical data	3
2. Approvals and conformities	4
2.1. Conformity	4
2.2. Standards.....	4
2.3. Pressure Equipment Directive (PED).....	4
Device used on a pipe	4
3. Materials	4
3.1. Bürkert resistApp	4
3.2. Material specifications	5
4. Dimensions	5
5. Product installation	6
5.1. Installation notes	6
6. Product operation	6
6.1. Measuring principle.....	6
7. Ordering information	7
7.1. Bürkert eShop	7
7.2. Bürkert product filter.....	7
7.3. Ordering chart.....	7
7.4. Ordering chart accessories.....	7

DTS 1000011095 EN Version: W Status: RL (released | freigegeben | validé) printed: 13.12.2023

1. General technical data

Product properties

Material

Make sure the device materials are compatible with the fluid you are using.
Further information can be found in chapter [“3.1. Bürkert resistApp” on page 4.](#)

Further information on the materials can be found in chapter [“3.2. Material specifications” on page 5.](#)

Non wetted parts

Screw	Stainless steel 316
Tag plate	Aluminium

Wetted parts

Axis	Alloy C
Oval gear	PPS
Sensor body	PPS
Cover	PPS
Seal	FFKM

Compatibility	With Type 8025 Universal transmitter/batch controller, Type 8611 eCONTROL Universal controller or Type 8619 multiCELL transmitter/Controller Further information can be found in the respective technical data sheets, see data sheets Type 8025 ▶, Type 8611 ▶, Type 8619 ▶ for more information.
---------------	--

Dimensions	Further information can be found in chapter “4. Dimensions” on page 5.
------------	--

Measuring principle	Oval gear
---------------------	-----------

Type of sensor	Hall effect (Transistor output) or Reed contact (reed switch output)
----------------	--

Measuring range	0.5...500 l/h (0.13...132 gph) (depends on the variant)
-----------------	---

Standard K factor	<ul style="list-style-type: none"> For flow range 0.5...120 l/h: 1000 pulses/l For flow range 15...500 l/h: 400 pulses/l
-------------------	--

Performance data

Measurement deviation	± 1 % of measured value
-----------------------	-------------------------

Repeatability	≤ 0.03 % of measured value
---------------	----------------------------

Electrical data

Operating voltage	4.5...24 V DC
-------------------	---------------

Current consumption	≤ 9 mA (Hall effect sensor)
---------------------	-----------------------------

Output	<ul style="list-style-type: none"> Hall effect sensor <ul style="list-style-type: none"> Frequency on open collector, NPN, max. 25 mA 4.5...24 V DC Recommended load: 1.8 KΩ Pull up at 24 V DC Reed contact <ul style="list-style-type: none"> Frequency Switching voltage: 30 V DC, Max. current: 0.5 A
--------	---

Medium data

Fluid temperature	-20...+80 °C (-4...+176 °F)
-------------------	-----------------------------

Fluid pressure	5 bar (72 PSI)
----------------	----------------

Dynamic viscosity η	1 Pa.s. max. (higher on request)
--------------------------	----------------------------------

Maximum particle size	75 μ m To prevent damage from dirt or foreign matter, we strongly recommend the installation of a 75 μ m (200 mesh) strainer as close as possible to the inlet side of the meter.
-----------------------	--

Process/Pipe connection & communication

Pipe connection	Thread ¼" (G or NPT)
-----------------	----------------------

Electrical connection	<ul style="list-style-type: none"> 5-wire cable 1 m length
-----------------------	--

Approvals and conformities

Directives

CE directive Further information on the CE Directive can be found in chapter [“2.2. Standards” on page 4.](#)

Pressure equipment directive Complying with article 4, paragraph 1 of 2014/68/EU directive
Further information on the pressure equipment directive can be found in chapter [“2.3. Pressure Equipment Directive \(PED\)” on page 4.](#)

Environment and installation

Ambient temperature	Operation and storage: - 15...+80 °C (+5...+176 °F)
Relative air humidity	≤ 85 %, without condensation
Height above sea level	Max. 2000 m
Operating condition	Continuous
Device mobility	Fixed
Application range	Indoor and outdoor Protect the device against electromagnetic interference, ultraviolet rays and, when installed outdoors, against the effects of climatic conditions.
Degree of protection	IP54 (NEMA 13)
Installation category	Category I according to UL/EN 61010-1
Pollution degree	Degree 2 according to UL/EN 61010-1

2. Approvals and conformities

2.1. Conformity

In accordance with the Declaration of Conformity, the product is compliant with the EU Directives.

2.2. Standards

The applied standards which are used to demonstrate compliance with the EU Directives are listed in the EU-Type Examination Certificate and/or the EU Declaration of Conformity.

2.3. Pressure Equipment Directive (PED)

The device conforms to article 4, paragraph 1 of the Pressure Equipment Directive (PED) 2014/68/EU under the following conditions:

Device used on a pipe

Note:

- The data in the table is independent of the chemical compatibility of the material and the fluid.
- PS = maximum admissible pressure (in bar), DN = nominal diameter of the pipe

Type of fluid	Conditions
Fluid group 1, article 4, paragraph 1.c.i	DN ≤ 25
Fluid group 2, article 4, paragraph 1.c.i	DN ≤ 32 or PS*DN ≤ 1000
Fluid group 1, article 4, paragraph 1.c.ii	DN ≤ 25 or PS*DN ≤ 2000
Fluid group 2, article 4, paragraph 1.c.ii	DN ≤ 200 or PS ≤ 10 or PS*DN ≤ 5000

3. Materials

3.1. Bürkert resistApp

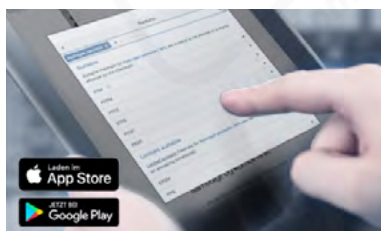

Bürkert resistApp – Chemical resistance chart

You want to ensure the reliability and durability of the materials in your individual application case? Verify your combination of media and materials on our website or in our resistApp.

[Start chemical resistance check](#)

3.2. Material specifications

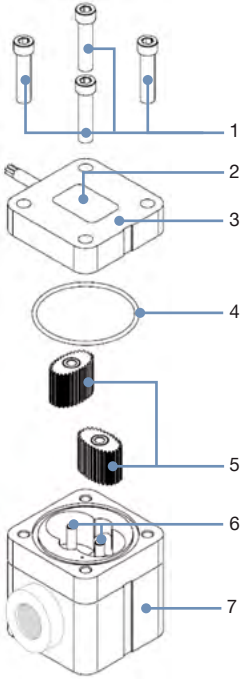

No.	Element	Material
1	Screws	Stainless steel 316
2	Tag plate	Aluminium
3	Cap	PPS
4	Seal	FFKM
5	Oval gear	PPS
6	Shaft	Alloy C
7	Body	PPS

4. Dimensions

Note:

Dimensions in mm, unless otherwise stated

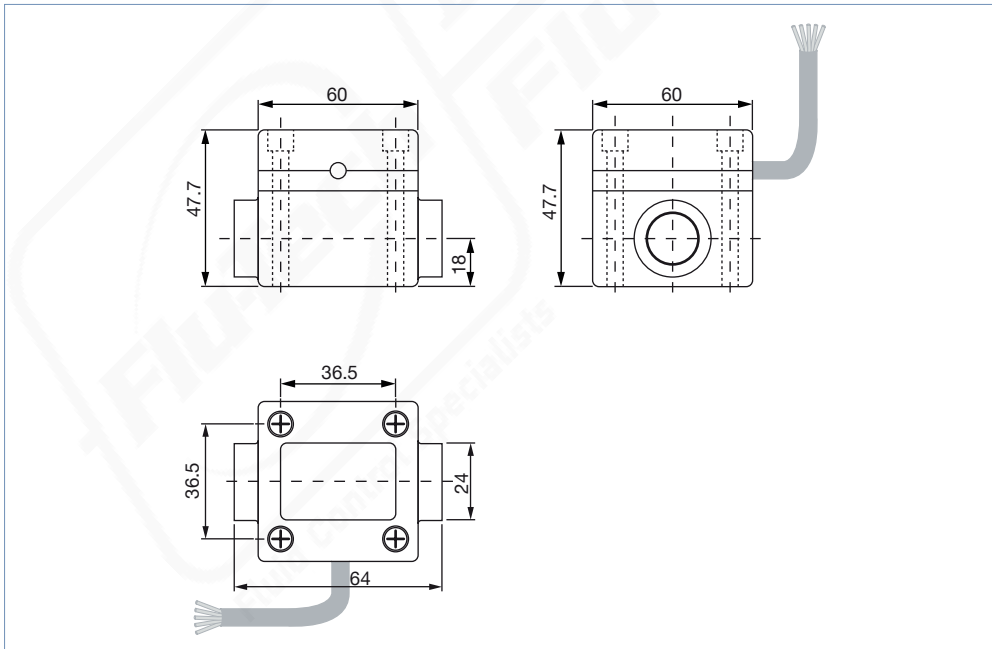

5. Product installation

5.1. Installation notes

Note:

The device is not suitable for use in gaseous media and steam.

The flowmeter can be installed in any orientation as long as **the rotor shafts are always in a horizontal plane.**

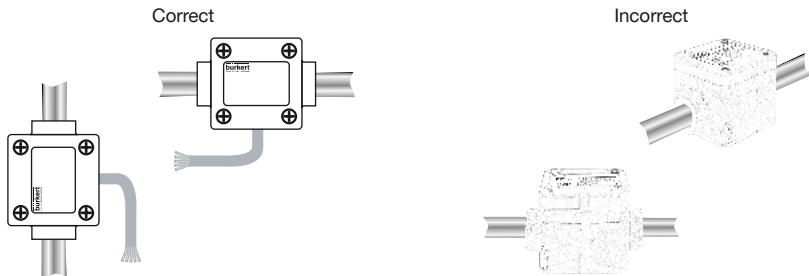

The following installation conditions must also be observed:

- The pipe always has to be filled with fluid at all times near the device.
- The pipe design must be such that no air bubbles or cavitation can form within the medium near the device at any time.
- We recommend the installation of a 75 µm strainer as close as possible to the inlet side of the meter, to prevent damage from particles,
- Air purges can damage the appliance and should therefore be avoided.

6. Product operation

6.1. Measuring principle

When liquid flows through the pipe, the rotors turn. This rotation produces a measuring signal in the associated Hall sensor. The rotation frequency of this signal is proportional to the flow velocity of the fluid. The volume of the fluid being transferred in this way is exactly determined through the sensor geometry.

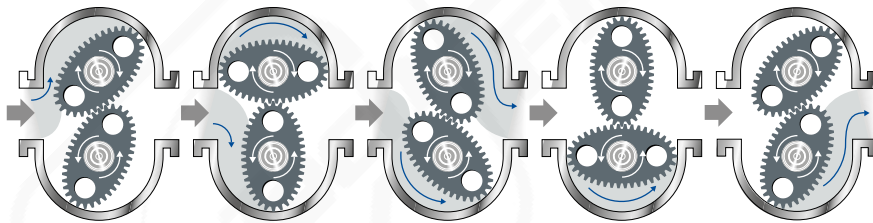

A conversion coefficient, specific to each meter size, enables the conversion of this frequency into a flow rate. The standard K-factor depending on the meter size is available in the flowmeter's operating instructions, see **Type 8071** ▶. To improve the measurement deviation, a device-specific K-factor is given on the device label.

7. Ordering information

7.1. Bürkert eShop



Bürkert eShop – Easy ordering and quick delivery

You want to find your desired Bürkert product or spare part quickly and order directly? Our online shop is available for you 24/7. Sign up and enjoy all the benefits.

[Order online now](#)

7.2. Bürkert product filter

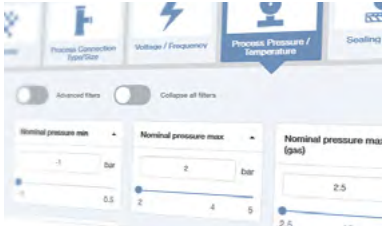

Bürkert product filter – Get quickly to the right product

You want to select products comfortably based on your technical requirements? Use the Bürkert product filter and find suitable articles for your application quickly and easily.

[Try out our product filter](#)

7.3. Ordering chart

Measuring range for fluid with viscosity		Pipe connection	Max. pressure	Material				Article no.
				Body	Rotor	Shaft	Seal	
>5 mPa.s	<5 mPa.s	G 1/4"	5 bar	PPS	PPS	Alloy C	FFKM	432288
0.5...100 l/h (0.13...26.4 gph)	2 ¹⁾ ...100 l/h (0.53...26.4 gph)							430856
15...500 l/h (4.00...132 gph)	40...500 l/h (10.56...132 gph)	NPT 1/4"						448654
0.5...100 l/h (0.13...26.4 gph)	2 ¹⁾ ...100 l/h (0.53...26.4 gph)							448655
15...500 l/h (4.00...132 gph)	40...500 l/h (10.56...132 gph)							

1.) For non-lubricating fluids = 6 l/h (e.g. water)

7.4. Ordering chart accessories

Description	Article no.
Set with two rotors in PPS for measuring range 0.5...100 l/h	550921
Set with two rotors in PPS for measuring range 15...500 l/h	550922
Cover made of PPS with Hall sensor and reed contact	553654
FFKM seal	550959

DTS 1000011095 EN Version: W Status: RL (released | freigegeben | validé) printed: 13.12.2023