







Inline sensor fitting with oval gears (positive displacement) for flow measurement

- DN15...DN100
- Inline Quarter-Turn Technology
- Electronics available for indication, monitoring, transmitting, On/Off control and batch control

Product variants described in the data sheet may differ from the product presentation and description.

Can be combined with

	Type SE30 Transmitter for Inline sensor-fitting	▶
	Type SE32 Transmitter for Inline sensor-fitting	▶
	Type SE35 Transmitter or batch controller for Inline sensor-fitting	▶
	Type SE36 ELEMENT transmitter for Inline sensor fitting	▶

Type description

This Inline sensor fitting Type S077 is specially designed for flow measurement or batch control of highly viscous fluids like glue, honey or oil.

This measuring element must be combined with a Bürkert transmitter Type SE30, Type SE30 Ex, Type SE32, Type SE35 or Type SE36 (only equipped with a Hall sensor). The assembly is quickly and easily done through a bayonet mounting and locking system. The Bürkert "Inline quarter-turn" technology ensures a leakage-free operation.

This Inline sensor fitting works according to the positive displacement principle (with oval gears), a reliable and highly accurate principle for volumetric flow measurement. This technology enables highly accurate and repeatable measurements over a wide range of flow rates and viscosities.

The low pressure drop and high pressure rating make it suitable for a wide range of applications: gravity flow or in-line flow (pump).

DTS 1000282306 EN Version: G Status: RL (released | freigegeben | validé) printed: 20.12.2023

FLU-TECH CO. LTD.

Email: sales@flutech.co.th **Website:** https://flutech.co.th

Tel: 02-384-6060, 086-369-5871-3 **Fax:** 02-384-5701 **LINE OA:** @flutech.co.th

Address (HQ): 845/3-4, Moo 3, Theparak Rd., T. Theparak, A. Mueang Samut Prakan, Samut Prakan, 10270, Thailand



Table of contents

1. General technical data	3
2. Approvals and conformities	4
2.1. Conformity	4
2.2. Standards.....	4
2.3. Pressure Equipment Directive (PED).....	4
Device used on a pipe	4
3. Materials	4
3.1. Bürkert resistApp	4
3.2. Material specifications	4
4. Dimensions	5
4.1. Internal thread connection	5
4.2. Flange connection.....	5
5. Product installation	6
5.1. Installation notes	6
6. Product operation	6
6.1. Measuring principle.....	6
7. Networking and combination with other Bürkert products	7
8. Ordering information	7
8.1. Bürkert eShop	7
8.2. Recommendation regarding product selection.....	7
8.3. Bürkert product filter	8
8.4. Ordering chart	8
8.5. Ordering chart accessories.....	9

1. General technical data

Product properties

Material

Make sure the device materials are compatible with the fluid you are using.
Further information can be found in chapter **"3.1. Bürkert resistApp"** on page 4.

Further information on the materials can be found in chapter **"3.2. Material specifications"** on page 4.

Non wetted parts

Screw Stainless steel 316

Wetted parts

Axis Stainless steel 316L (1.4401)
 Oval gear Stainless steel 316L (1.4401)
 Sensor-fitting body Aluminium, stainless steel 316L (1.4401)
 Cover Aluminium, stainless steel 316L (1.4401)
 Seal FKM or FEP/PTFE encapsulated

Compatibility With transmitter Type SE30, Type SE32, Type SE35, Type SE36 with Hall sensor principle
 Further information can be found in the respective technical data sheets, see **data sheets**
Type SE30 + S077 ▶, **Type SE32 + S077** ▶, **Type SE35 + S077** ▶, **Type SE36 + S077** ▶.

Pipe diameter DN 15...DN 100

Dimensions Further information can be found in chapter **"4. Dimensions"** on page 5.

Measuring principle Oval gear

Measuring range

- Viscosity >5 mPa.s: 2...1200 l/min (0.53...320 gpm)
- Viscosity <5 mPa.s: 3...1000 l/min (0.78...266.66 gpm)

Performance data

Measurement deviation

- Teach-in or specific K factor (engraved on the sensor fitting): $\pm 0.5\%$ of the measured value at Teach-In flow rate value
- Standard K factor: $\pm 1\%$ of the measured value

Repeatability $\pm 0.03\%$ of the measured value

Medium data

Fluid temperature With Inline sensor fitting S077 in:

- Aluminium: $-20...+80\text{ °C}$ ($-4...+176\text{ °F}$)
- Stainless steel: $-20...+120\text{ °C}$ ($-4...+248\text{ °F}$)

Fluid pressure With Inline sensor fitting S077 with:

- DN 15: max. 55 bar (798.05 PSI) (threaded process connection)
- DN 25: max. 55 bar (798.05 PSI)¹⁾
- DN 40 or DN 50: max. 18 bar (261.18 PSI)
- DN 80: max. 12 bar (174.12 PSI)
- DN 100: max. 10 bar (145.1 PSI)

Viscosity Max. 1 Pa.s (higher on request)

Rate of solid particles 0%

Process/Pipe connection & communication

Pipe connection

- Thread: ½", 1", 1½", 2" or 3" (G or NPT)
- Flange:
 - 25, 40, 50, 80 or 100 mm DIN PN 16 flange
 - 1", 1½", 2", 3" or 4" ANSI 150LB flange

Approvals and conformities

Directives

CE directive²⁾ Further information on the CE Directive can be found in chapter **"2.2. Standards"** on page 4.

Pressure equipment directive Complying with Article 4, Paragraph 1 of 2014/68/EU directive
 Further information on the pressure equipment directive can be found in chapter **"2.3. Pressure Equipment Directive (PED)"** on page 4.

Environment and installation

Ambient temperature Operation and storage: $0...+60\text{ °C}$ ($+32...+140\text{ °F}$)

1.) Or in accordance to the value of the used flanges

2.) Without CE marking

2. Approvals and conformities

2.1. Conformity

In accordance with the Declaration of Conformity, the product is compliant with the EU Directives.

2.2. Standards

The applied standards which are used to demonstrate compliance with the EU Directives are listed in the EU-Type Examination Certificate and/or the EU Declaration of Conformity.

2.3. Pressure Equipment Directive (PED)

The device conforms to article 4, paragraph 1 of the pressure equipment directive 2014/68/EU under the following conditions:

Device used on a pipe

Note:

- The data in the table is independent of the chemical compatibility of the material and the fluid.
- PS = maximum admissible pressure (in bar), DN = nominal diameter of the pipe

Type of fluid	Conditions
Fluid group 1, article 4, paragraph 1.c.i	DN ≤ 25
Fluid group 2, article 4, paragraph 1.c.i	DN ≤ 32 or PS*DN ≤ 1000
Fluid group 1, article 4, paragraph 1.c.ii	DN ≤ 25 or PS*DN ≤ 2000
Fluid group 2, article 4, paragraph 1.c.ii	DN ≤ 200 or PS ≤ 10 or PS*DN ≤ 5000

3. Materials

3.1. Bürkert resistApp



Bürkert resistApp – Chemical resistance chart

You want to ensure the reliability and durability of the materials in your individual application case? Verify your combination of media and materials on our website or in our resistApp.

[Start chemical resistance check](#)

3.2. Material specifications

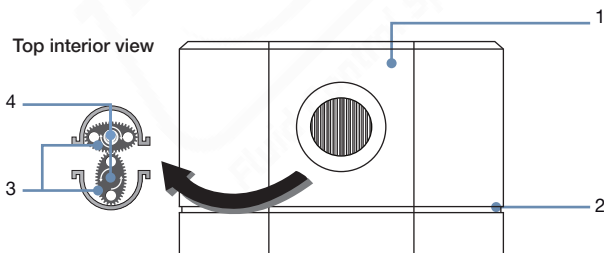

No.	Element	Material
1	Sensor fitting body	Stainless steel
2	Seal	FKM or FEP/PTFE encapsulated
3	Oval gear	PPS, aluminium or stainless steel (316L)
4	Axis	Stainless steel (316L)

4. Dimensions

4.1. Internal thread connection

Note:

Dimensions in mm, unless otherwise stated

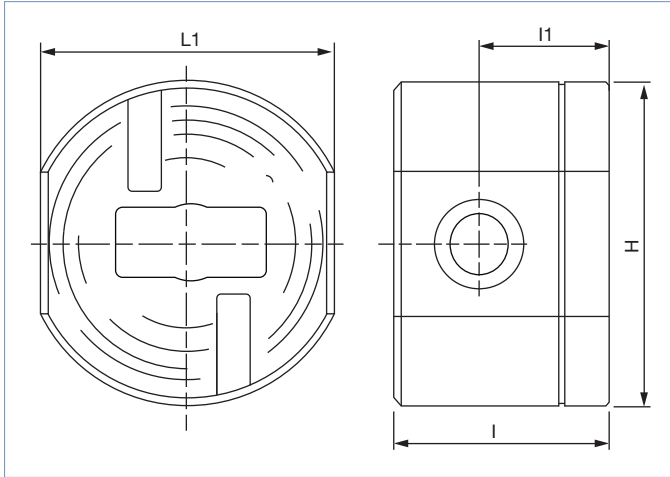

DN	H	L1		I	I1
		Stainless steel	Aluminium		
15	87	81	81	49	28
25	112	100	100	75	45
40	137	120	120	103	61
50	163	140	140	124	72
80	220	260	302	180	80

4.2. Flange connection

Note:

Dimensions in mm, unless otherwise stated

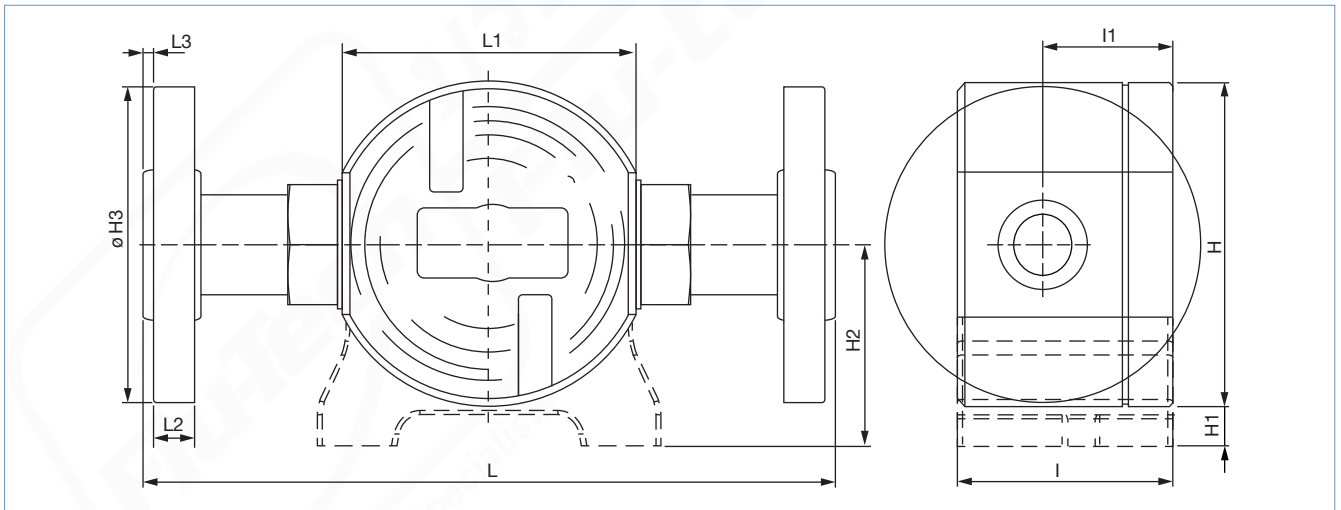

DN	H	H1	H2	ØH3		L				L1	L2		L3		I	I1
				DIN	ANSI	DIN	ANSI	DIN	ANSI		DIN	ANSI	DIN	ANSI		
25	112	-	-	115	108	240	240	240	240	100	16.0	12.7	2	2	75	45
40	137	-	-	150	125	240	240	240	240	120	16.0	15.9	3	2	103	61
50	163	-	-	165	152	264	264	264	264	140	18.0	17.5	3	2	124	72
80	226	28	141	200	191	344	348	435	435	-	20.0	27.4	3	1.6	180	78
100	291	42	191	220	229	-	-	583	583	-	30.2	28.4	0	1.6	226	108

DTS 1000282306 EN Version: G Status: RL (released | freigegeben | validé) printed: 20.12.2023

5. Product installation

5.1. Installation notes

Note:

- The following installation view uses a picture of a transmitter Type SE30 mounted on an Inline sensor fitting Type S077. This also applies to all variants of the Type S077 mounted with either transmitter Type SE32, Type SE35 or Type SE36.
- The device is not suitable for use in gaseous media and steam.

The sensor fitting can be installed in any orientation as long as **the rotor shafts are always in a horizontal plane**.

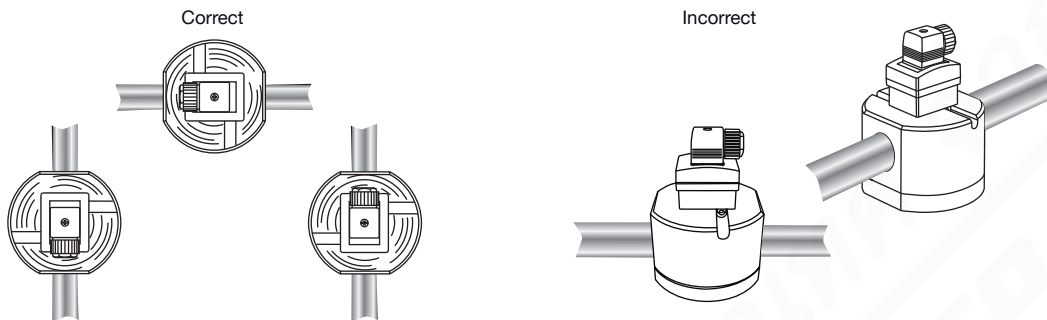

The following installation conditions must also be observed:

- The pipe always has to be filled with fluid at all times near the device.
- The pipe design must be such that no air bubbles or cavitation can form within the medium near the device at any time.
- We recommend the installation of a 75 µm strainer as close as possible to the inlet side of the meter, to prevent damage from particles,
- Air purges can damage the appliance and should therefore be avoided.

6. Product operation

6.1. Measuring principle

When liquid flows through the pipe, the rotors turn. This rotation produces a measuring signal in the associated Hall sensor. The rotation frequency of this signal is proportional to the flow velocity of the fluid. The volume of the fluid being transferred in this way is exactly determined through the sensor geometry.

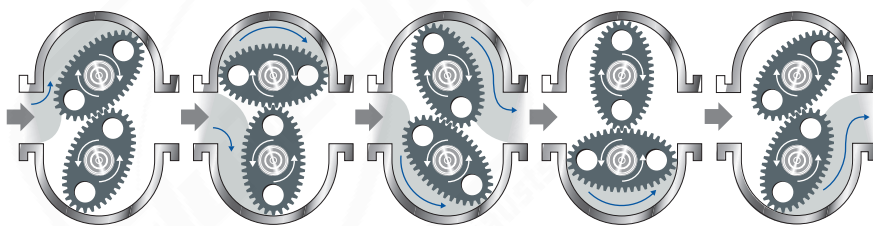

A conversion coefficient, specific to each meter size, enables the conversion of this frequency into a flow rate. The standard K factor depending on the meter size is available in the flowmeter's operating instructions, see **Type S077** ▶. To improve the measurement deviation, a device-specific K factor is given on the device label.

7. Networking and combination with other Bürkert products

Example:



<p>Type SE30 ▶ Transmitter for Inline sensor fitting variant with Hall transducer</p>	<p>Type SE30 Ex ▶ Transmitter for Inline sensor fitting ATEX variant</p>	<p>Type SE32 ▶ Transmitter for Inline sensor fitting variant with Hall transducer</p>	<p>Type SE35 ▶ Transmitter or batch controller for Inline sensor fitting variant with Hall transducer</p>	<p>Type SE36 ▶ ELEMENT transmitter for Inline sensor fitting variant with Hall transducer</p>

8. Ordering information

8.1. Bürkert eShop



Bürkert eShop – Easy ordering and quick delivery

You want to find your desired Bürkert product or spare part quickly and order directly? Our online shop is available for you 24/7. Sign up and enjoy all the benefits.

[Order online now](#)

8.2. Recommendation regarding product selection

A complete device to measure the flow rate is made up of a compact Inline sensor-fitting Type S077 with oval gears and a transmitter Type SE30, Type SE30 Ex, Type SE32, Type SE35 or Type SE36, see [data sheet Type SE30 ▶](#), [data sheet Type SE32 ▶](#), [data sheet Type SE35 ▶](#) or [data sheet Type SE36 ▶](#).

Two different components must be ordered in order to select a complete device. The following information is required:

- **Article no.** of the desired flow transmitter (see [data sheet Type SE30 ▶](#), [data sheet Type SE32 ▶](#), [data sheet Type SE35 ▶](#) or [data sheet Type SE36 ▶](#))
- **Article no.** of the selected S077 Inline sensor-fitting (see chapter [“8.4. Ordering chart” on page 8](#))

8.3. Bürkert product filter



Bürkert product filter – Get quickly to the right product

You want to select products comfortably based on your technical requirements? Use the Bürkert product filter and find suitable articles for your application quickly and easily.















[Try out our product filter](#)

8.4. Ordering chart

DN	Measuring range for fluid with viscosity		Pipe connection	Material			Article no.
	> 5 mPa.s	< 5 mPa.s		Body	Oval gear	Seal	
	[l/min]	[l/min]					
15	2...30	3...25	G 1/2"	Aluminium	PPS	FKM	567223
				Stainless steel	Stainless steel	FEP/PTFE	567224
			NPT 1/2"	Aluminium	PPS	FKM	567225
				Stainless steel	Stainless steel	FEP/PTFE	567226
25	6...120	10...100	G 1"	Aluminium	PPS	FKM	567227
				Stainless steel	Stainless steel	FEP/PTFE	567228
			NPT 1"	Aluminium	PPS	FKM	567229
				Stainless steel	Stainless steel	FEP/PTFE	567230
			25 mm DIN PN 16 flange	Aluminium	PPS	FKM	567231
				Stainless steel	Stainless steel	FEP/PTFE	567232
			1" ANSI 150 LB flange	Aluminium	PPS	FKM	567233
				Stainless steel	Stainless steel	FEP/PTFE	567234
40	10...250	15...235	G 1 1/2"	Aluminium	PPS	FKM	567235
				Stainless steel	Stainless steel	FEP/PTFE	567236
	10...250	15...235	NPT 1 1/2"	Aluminium	PPS	FKM	567237
				Stainless steel	Stainless steel	FEP/PTFE	567238
	10...250	15...235	40 mm DIN PN 16 flange	Aluminium	PPS	FKM	567239
				Stainless steel	Stainless steel	FEP/PTFE	567240
	10...250	15...235	1 1/2" ANSI 150 LB flange	Aluminium	PPS	FKM	567241
				Stainless steel	Stainless steel	FEP/PTFE	567242
50	15...350	30...300	G 2"	Aluminium	PPS	FKM	567243
			NPT 2"	Aluminium	PPS	FKM	567244
	15...350	30...300	50 mm DIN PN 16 flange	Aluminium	PPS	FKM	567245
				Stainless steel	Stainless steel	FEP/PTFE	567246
	15...350	30...300	2" ANSI 150 LB flange	Aluminium	PPS	FKM	567247
				Stainless steel	Stainless steel	FEP/PTFE	567248
80	20...733	66...616	G 3"	Aluminium	Aluminium	FKM	567249
			NPT 3"	Aluminium	Aluminium	FKM	567250
	20...733	66...616	80 mm DIN PN 16 flange	Aluminium	Aluminium	FKM	567251
	20...733	66...616	3" ANSI 150 LB flange	Aluminium	Aluminium	FKM	567252
	100	120...1200	220...1000	100 mm DIN PN 16 flange	Aluminium	Aluminium	FKM
4" ANSI 150 LB flange				Aluminium	Aluminium	FKM	567254

DTS 1000282306 EN Version: G Status: RL (released | freigegeben | valide) printed: 20.12.2023

8.5. Ordering chart accessories

Orifice size		Material	Article no.
[mm]	[inch]		
Oval gears			
DN 15	½"	PPS	567741 
		Stainless steel	567742 
DN 25	1"	PPS	567743 
		Stainless steel	567744 
DN 40	1½"	PPS	567745 
		Stainless steel	567746 
DN 50	2"	PPS	567747 
		Stainless steel	567748 
O-ring			
DN 15	½"	FEP/PTFE	567754 
		FKM	567755 
DN 25	1"	FEP/PTFE	567756 
		FKM	567757 
DN 40	1½"	FEP/PTFE	567758 
		FKM	567759 
DN 50	2"	FEP/PTFE	567760 
		FKM	567761 