



Pressure measuring device / Switch

- Indication, monitoring, transmitting and continuous or On/Off control in one device
- Output signal 4...20 mA, 2-wire for continuous control
- Transistor or relay outputs for On/Off control or alarm function

Product variants described in the data sheet may differ from the product presentation and description.

Can be combined with



Type 8644

Remote Process Actuation Control System AirLINE



Type 8802

ELEMENT continuous control valve systems - overview



Type 6213

Servo-assisted 2/2 way diaphragm valve

Type description

This intelligent mini transmitter/switch with an extra-large display is specially designed to switch alarms and to establish a monitoring system or an On/Off control loop.

The switching points can be programmed with the three-key keypad under the display. In addition, the process value can be transmitted to the PLC (4...20 mA).

The connection to the process in the piping is made using standard fittings (G 1/2", NPT 1/2", Rc 1/2").



Table of contents

1. General technical data	3
2. Approvals	5
2.1. Pressure Equipment Directive.....	5
Device used on a pipe	5
Device used on a vessel	5
3. Materials	5
3.1. Chemical Resistance Chart – Bürkert resistApp.....	5
3.2. Material specifications	6
4. Dimensions	6
4.1. Transmitter with a EN 175301-803 female cable plug	6
4.2. Transmitter or switch with a M12 plug.....	7
4.3. Switch with a EN 175301-803 female cable plug and a M12 plug.....	7
5. Product operation	8
5.1. Measuring principle	8
5.2. Functional overview	8
Display and operating keys.....	8
Operating levels	9
Function modes	9
6. Ordering information	10
6.1. Bürkert eShop – Easy ordering and quick delivery.....	10
6.2. Bürkert product filter.....	10
6.3. Ordering chart.....	10
Transmitter version.....	10
Switch version	12
6.4. Ordering chart accessories.....	13

1. General technical data

Product properties

Material

Please make sure the device materials are compatible with the fluid you are using.

Detailed information can be found in chapter "3.1. Chemical Resistance Chart – Bürkert resistApp" on page 5.

Non wetted parts

Housing, cover	PC, +20 % glass fibre
Cover seal	Silicone
Front panel foil	Polyester
Seal	FKM (EPDM on request)
Screws	Stainless steel
Plug	<ul style="list-style-type: none"> Female cable plug/male fixed plug in PA (body, contact holder and cable gland) with electrical contact in Sn and cable gland seal and flat seal in NBR Swivel 5-pins M12 male fixed plug in PA with electrical contact in brass, gold-plated
Flat seal	NBR

Wetted parts

Process connection	Stainless steel 1.4404 (316L)
Measurement element	Stainless steel 1.4404 (316L)
Seal	FKM (EPDM on request)
Dimensions	Detailed information can be found in chapter "4. Dimensions" on page 6.
Compatibility	Any pipe with a 1/2" threaded sensor connection piece (G, NPT or Rc)
Measurement technology	Piezo-resistive
Measured variable	Relative pressure
Sensor element	Ceramic cell (Al ₂ O ₃)
Measuring range	0...1, 2, 5, 10, 20 or 50 bar (0...14, 29, 73, 145, 290 or 725 PSI) Detailed information can be found in chapter "6.3. Ordering chart" on page 10.
Weight	200 g...350 g according to the version

Performance data

Measurement deviation	<ul style="list-style-type: none"> Transmitter 2-wire version: <ul style="list-style-type: none"> for $-20\text{ °C} < T_{\text{fluid}} < 0\text{ °C}$: $\leq \pm 1\% \pm 0.03\%$ of full scale / °C for $0\text{ °C} < T_{\text{fluid}} < 70\text{ °C}$: $\leq \pm 1\%$ of full scale for $70\text{ °C} < T_{\text{fluid}} < 100\text{ °C}$: $\leq \pm 1\% \pm 0.03\%$ of full scale / °C Switch version: $\leq \pm 1.5\%$ of full scale
Repeatability	<ul style="list-style-type: none"> Transmitter 2-wire version: $\leq \pm 0.06\%$ (typical) Switch version: $\leq \pm 0.25\%$ (typical)
Measuring range resolution	Transmitter 2-wire version with a: <ul style="list-style-type: none"> 0...1 bar cell: 0.5 mbar 0...2 bar cell: 1.33 mbar 0...5 bar cell: 3.33 mbar 0...10 bar cell: 5 mbar 0...20 bar cell: 10 mbar 0...50 bar cell: 25 mbar
Overload / bursting pressure	<ul style="list-style-type: none"> 0...1 bar cell: 2 bar (29 PSI) / 4 bar (58 PSI) 0...2 bar cell: 4 bar (58 PSI) / 7 bar (101 PSI) 0...5 bar cell: 10 bar (145 PSI) / 12 bar (174 PSI) 0...10 bar cell: 20 bar (290 PSI) / 25 bar (362 PSI) 0...20 bar cell: 40 bar (580 PSI) / 50 bar (725 PSI) 0...50 bar cell: 100 bar (1450 PSI) / 120 bar (1740 PSI)
Service life of pressure cell	Min. 100 million cycles

Electrical data

Operating voltage	12...30 V DC, filtered and regulated
Power source (not supplied)	The auxiliary energy of the pressure sensor must meet SELV requirements; optionally, an energy-limited current circuit according to section 9.3 of DIN EN 61010-1 and UL 61010-1 can be used.

Current consumption	<ul style="list-style-type: none"> • Transmitter 2-wire version: < 30 mA (+ 700 mA max. per transistor output used) • Switch version: ≤ 80 mA, no load
DC reverse polarity protection	Yes, for power supply and all outputs
Overvoltage protection	Yes, for power supply and for transistor outputs
Outputs	<ul style="list-style-type: none"> • Transmitter 2-wire version: <ul style="list-style-type: none"> – Transistor (programmable): 2 NPN or 2 PNP, can be modified by means of straps, open collector, max. 700 mA, NPN: (V+) minus 0.5 V DC / 0 V DC PNP: 0.5 V DC / (V+) protected against short circuit – Process value: 4...20 mA, response time (10...90 %): 300 ms with filter 0 (default setting) max. loop resistance: 800 Ω at 30 V DC, 550 Ω at 24 V DC, 300 Ω at 18 V DC (for more details, see instruction manual Type 8311 ▶) • Switch version: <ul style="list-style-type: none"> – Transistor (programmable): NPN or PNP, max. 700 mA, NPN: 0.2...30 V DC PNP: (V+) protected against short circuit – Optional relay (programmable): Normally open/normally closed 3 A / 250 V AC or 3 A / 30 V DC
Voltage supply cable	<ul style="list-style-type: none"> • Shielded • Max. 50 m length • Cross section of wires: 0.25...0.5 mm²

Medium data

Fluid	Liquid and gaseous medium
Fluid temperature	-20...100 °C (-4...+212 °F) (+ 100 °C (+212 °F) for an ambient temperature of max. 40 °C(+104 °F))

Process/Port connection & communication

Process connection	G, NPT, Rc ½" screw-in thread
Electrical connection	<ul style="list-style-type: none"> • Cable plug according to EN 17530–803 (provided) • Swivel 5 pin M12 male fixed connector for female 5 pin M12 cable plug (not provided, to be ordered separately. Detailed information can be found in chapter "6.4. Ordering chart accessories" on page 13.)

Approvals and certificates

Standards

Degree of protection according to IEC/EN 60529	<p>IP65 under the following conditions:</p> <ul style="list-style-type: none"> • connector being plugged-in and tightened and • with an EN 175301-803 connector: device wired with a cable with a diameter of 6...7 mm
--	--

Directives

CE directives	The applied standards, which verify conformity with the EU Directives, can be found on the EU Type Examination Certificate and/or the EU Declaration of conformity (if applicable).
Pressure Equipment Directive	Complying with Article 4, Paragraph 1 of 2014/68/EU directive Detailed information on the pressure equipment directive can be found in chapter "2.1. Pressure Equipment Directive" on page 5.

Environment and installation

Ambient temperature	0...+60 °C (32...+140 °F)
Relative air humidity	≤ 80 %, without condensation
Height above sea level	Max. 2000 m
Operating conditions	Continuous
Equipment mobility	Fixed
Application range	Indoor and outdoor (protect the device against electromagnetic interference, ultraviolet rays and, when installed outdoors, against the effects of climatic conditions)
Installation category	Category I according to UL/EN 61010-1
Pollution degree	Degree 2 according to UL/EN 61010-1

2. Approvals**2.1. Pressure Equipment Directive**

The device conforms to Article 4, Paragraph 1 of the Pressure Equipment Directive 2014/68/EU under the following conditions:

Device used on a pipe**Note:**

- The data in the table is independent of the chemical compatibility of the material and the fluid.
- PS = maximum admissible pressure, DN = nominal diameter of the pipe

Type of fluid	Conditions
Fluid group 1, Article 4, Paragraph 1.c.i	DN ≤ 25
Fluid group 2, Article 4, Paragraph 1.c.i	DN ≤ 32 or PS*DN ≤ 1000
Fluid group 1, Article 4, Paragraph 1.c.ii	DN ≤ 25 or PS*DN ≤ 2000
Fluid group 2, Article 4, Paragraph 1.c.ii	DN ≤ 200 or PS ≤ 10 or PS*DN ≤ 5000

Device used on a vessel**Note:**

- The data in the table is independent of the chemical compatibility of the material and the fluid.
- PS = maximum admissible pressure, V = vessel volume

Type of fluid	Conditions
Fluid group 1, Article 4, Paragraph 1.a.i	V > 1 L and PS*V ≤ 25 bar.L or PS ≤ 200 bar
Fluid group 2, Article 4, Paragraph 1.a.i	V > 1 L and PS*V ≤ 50 bar.L or PS ≤ 1000 bar
Fluid group 1, Article 4, Paragraph 1.a.ii	V > 1 L and PS*V ≤ 200 bar.L or PS ≤ 500 bar
Fluid group 2, Article 4, Paragraph 1.a.ii	PS > 10 bar and PS*V ≤ 10000 bar.L or PS ≤ 1000 bar

3. Materials**3.1. Chemical Resistance Chart – Bürkert resistApp****Bürkert resistApp – Chemical Resistance Chart**

You want to ensure the reliability and durability of the materials in your individual application case? Verify your combination of media and materials on our website or in our resistApp.

[Start Chemical Resistance Check](#)

3.2. Material specifications

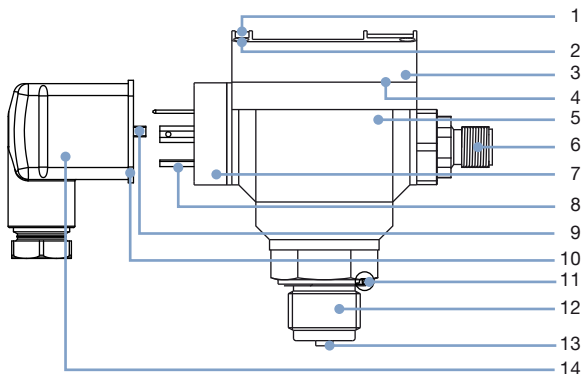

No.	Element	Material
1	Front panel folio	Polyester
2	Screws	Stainless steel
3	Cover seal	Silicone
4	Cover	PC, glass fibre reinforced
5	Housing	PC, glass fibre reinforced
6	M12 male fixed plug	PA with electrical contact in brass, gold-plated
7	Male fixed plug (EN 175301-803)	PA
8	Electrical contact	Sn
9	Screw	Stainless steel
10	Flat seal	NBR
11	Seal	FKM (EPDM on request)
12	Process connection	Stainless steel 316L (1.4404)
13	Measurement element	Stainless steel 316L (1.4404)
14	Female cable plug (EN 175301-803)	<ul style="list-style-type: none"> • Body, contact holder and cable gland in PA • Cable gland seal and flat seal in NBR

4. Dimensions

4.1. Transmitter with a EN 175301-803 female cable plug

Note:

Dimensions in mm

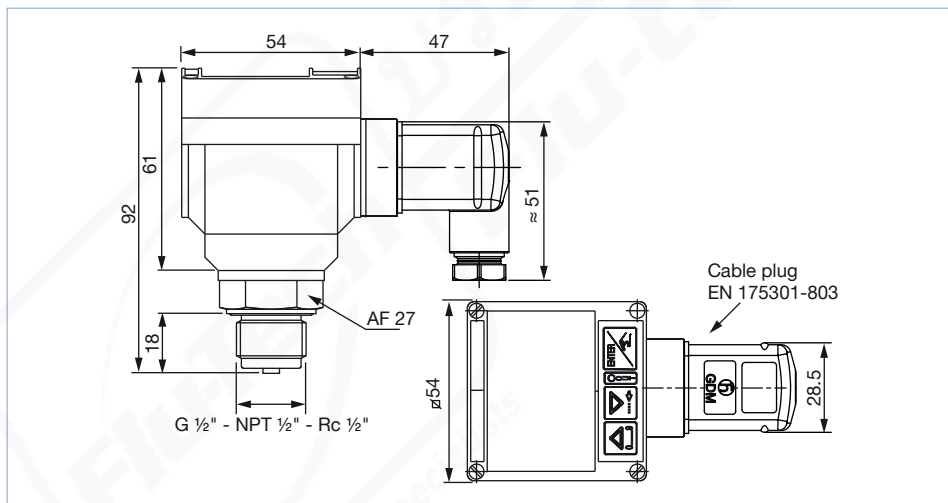

DTS 1000011110 EN Version: W Status: RL (released | freigegeben | valide) printed: 20.07.2022

4.2. Transmitter or switch with a M12 plug

Note:

Dimensions in mm

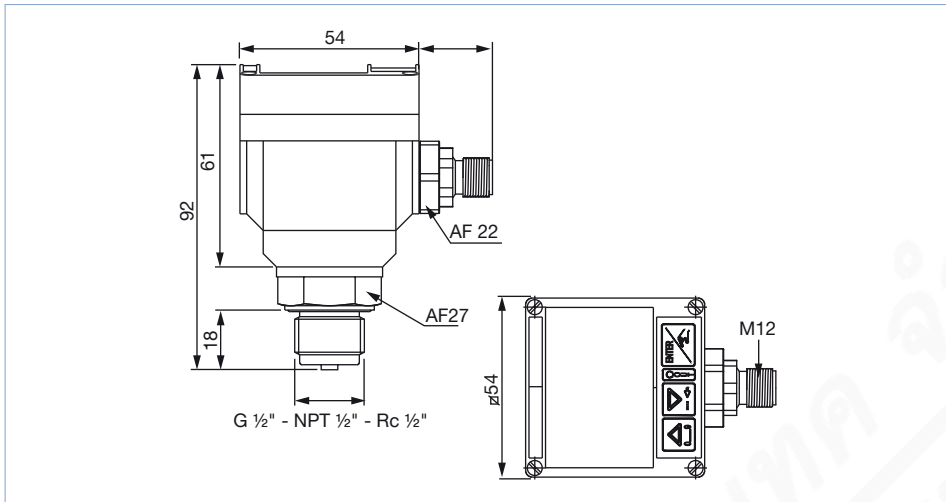

4.3. Switch with a EN 175301-803 female cable plug and a M12 plug

Note:

Dimensions in mm

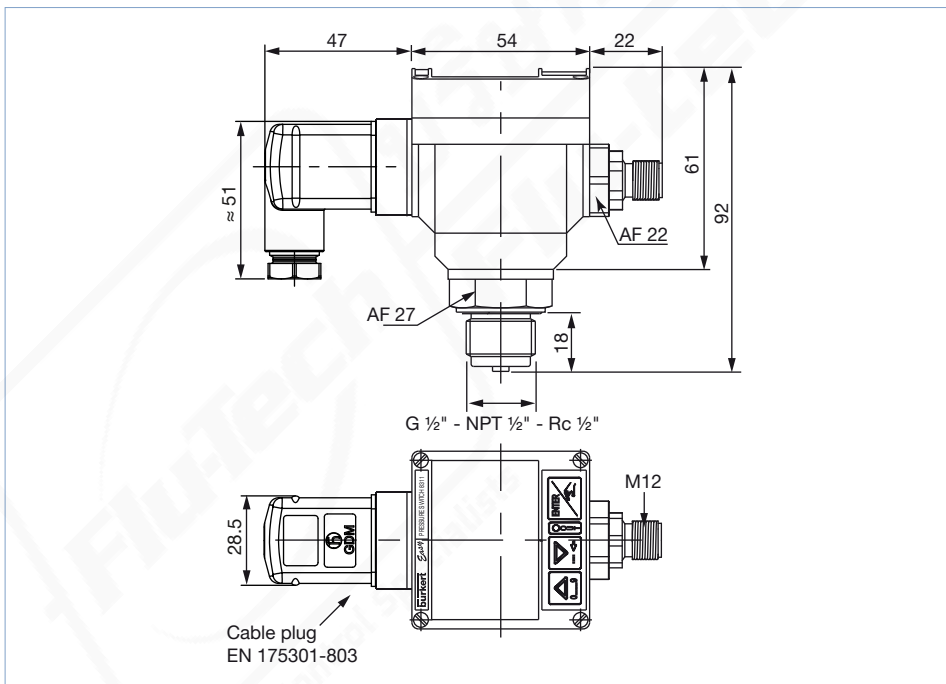

DTS 1000011110 EN Version: W Status: RL (released | freigegeben | validé) printed: 20.07.2022

5. Product operation

5.1. Measuring principle

The core element of all pressure transmitters is the pressure measuring cell. The transmitter/switch 8311 uses a piezo-resistive ceramic cell and work following the piezoresistive principle.

The pressure sensor is composed of 4 resistors in a Wheatstone bridge design. The resistive elements, which constitute a strain gauge, are implemented on a metallic/ceramic diaphragm.

Applying pressure to the diaphragm results in a resistance change in the strain gauge in direct proportion to the applied pressure. Applying a constant voltage to the wheatstone bridge results in a pressure proportional signal on the output side of the bridge.

5.2. Functional overview

Display and operating keys

The display is used to:

- read the value of certain parameters e.g. the measured pressure, the value of the output current (transmitter version), the programmed switching thresholds (switch version)...
- parameters of the device by means of 3 keys

Display and operating keys	No.	Description
	1	“Back” key: <ul style="list-style-type: none"> • to change the value (0...9) of the selected digit • to go back to the previous function
	2	“Next” key: <ul style="list-style-type: none"> • to select the digit at the left • to go to the next function
	3	“Confirm” key: <ul style="list-style-type: none"> • to confirm the function displayed • to confirm the parameters set
	4	Status LED of transistor output (LED ON = contact closed)
	5	Bargraph, active at any menu level

Operating levels

The device has 3 operating levels:

- the Normal level
- the Calibration level
- the Test level

Operating level	Functions
Normal	<ul style="list-style-type: none"> • Indication of <ul style="list-style-type: none"> - for the transmitter version <ul style="list-style-type: none"> - the value of the measured pressure - the value of the 4...20 mA output - the min. and max. pressures reached in the process since the last reset. - for the switch version <ul style="list-style-type: none"> - the value of the measured pressure - the high and low threshold values • Reset the min. and max. process pressure values (transmitter version) • Access to the Calibration and Test level
Calibration	<p>To make the settings needed for operation:</p> <ul style="list-style-type: none"> • pressure units (International measuring units) • switching mode of the output • switching thresholds (low and high) • delay before switching • filter (damping) • 10-segment bargraph (min. and max. values) and • for the transmitter version <ul style="list-style-type: none"> - 4...20-mA-current output - behaviour of transistors, current outputs if the pressure is outside the measuring range and/or when an error is displayed - access code for Calibration and Test level • for the switch version <ul style="list-style-type: none"> - switch zero point at nil pressure - K-factor/Teach-In function
Test	<ul style="list-style-type: none"> • To check the switching thresholds after entering a theoretical pressure value • and for the transmitter version <ul style="list-style-type: none"> - access to zero point, K-factor and current output adjustments - reset of the Calibration and/or Test levels to default parameters

Function modes

Note:

- Two switching modes for the output, either hysteresis or window, inverted or not
- The change of state occurs when a threshold is detected

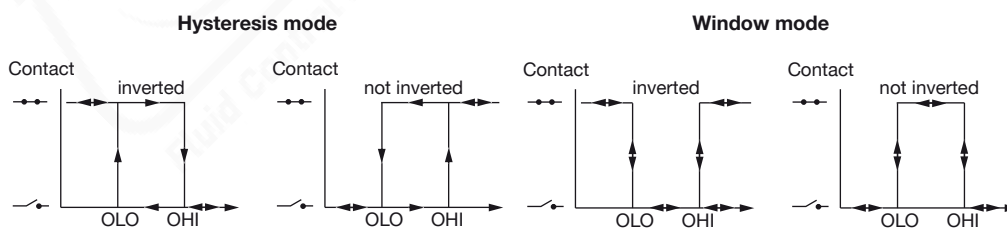

Visit product website ▶

6. Ordering information

6.1. Bürkert eShop – Easy ordering and quick delivery



Bürkert eShop – Easy ordering and fast delivery

You want to find your desired Bürkert product or spare part quickly and order directly? Our online shop is available for you 24/7. Sign up and enjoy all the benefits.

[Order online now](#)

6.2. Bürkert product filter

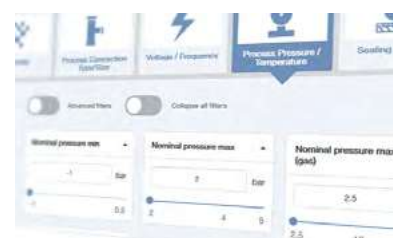

Bürkert product filter – Get quickly to the right product























You want to select products comfortably based on your technical requirements? Use the Bürkert product filter and find suitable articles for your application quickly and easily.

[Try out our product filter](#)

6.3. Ordering chart

Transmitter version

Operating voltage	Nominal pressure range [bar]	Pressure max. [bar]	Burst pressure [bar]	Output signal	Electrical connection	Article no.
Sensor connection G 1/2"						
12...30 V DC	0...1	2	4	4...20 mA + 2 NPN or 2 PNP ¹⁾	Swivel 5 pin M12 male fixed connector	557934
				4...20 mA	Female cable plug EN 175301-803	550350
	0...2	4	7	4...20 mA + 2 NPN or 2 PNP ¹⁾	Swivel 5 pin M12 male fixed connector	444507
				4...20 mA	Female cable plug EN 175301-803	444635
	0...5	10	12	4...20 mA + 2 NPN or 2 PNP ¹⁾	Swivel 5 pin M12 male fixed connector	444506
				4...20 mA	Female cable plug EN 175301-803	444636
	0...10	20	25	4...20 mA + 2 NPN or 2 PNP ¹⁾	Swivel 5 pin M12 male fixed connector	444503
				4...20 mA	Female cable plug EN 175301-803	550338
	0...20	40	50	4...20 mA + 2 NPN or 2 PNP ¹⁾	Swivel 5 pin M12 male fixed connector	444504
				4...20 mA	Female cable plug EN 175301-803	550339
	0...50	100	20	4...20 mA + 2 NPN or 2 PNP ¹⁾	Swivel 5 pin M12 male fixed connector	444505
				4...20 mA	Female cable plug EN 175301-803	444637

Operating voltage	Nominal pressure range	Pressure max. [bar]	Burst pressure [bar]	Output signal	Electrical connection	Article no.	
	[bar]						
Sensor connection NPT ½"							
12...30 V DC	0...1	2	4	4...20 mA + 2 NPN or 2 PNP ^{1.)}	Swivel 5 pin M12 male fixed connector	557935 	
				4...20 mA	Female cable plug EN 175301-803	557937 	
	0...2	4	7	4...20 mA + 2 NPN or 2 PNP ^{1.)}	Swivel 5 pin M12 male fixed connector	444762 	
				4...20 mA	Female cable plug EN 175301-803	444640 	
	0...5	10	12	4...20 mA + 2 NPN or 2 PNP ^{1.)}	Swivel 5 pin M12 male fixed connector	444763 	
				4...20 mA	Female cable plug EN 175301-803	444641 	
	0...10	20	25	4...20 mA + 2 NPN or 2 PNP ^{1.)}	Swivel 5 pin M12 male fixed connector	444764 	
				4...20 mA	Female cable plug EN 175301-803	444642 	
	0...20	40	50	4...20 mA + 2 NPN or 2 PNP ^{1.)}	Swivel 5 pin M12 male fixed connector	444765 	
				4...20 mA	Female cable plug EN 175301-803	444760 	
	0...50	100	20	4...20 mA + 2 NPN or 2 PNP ^{1.)}	Swivel 5 pin M12 male fixed connector	444767 	
				4...20 mA	Female cable plug EN 175301-803	444761 	
	Sensor connection Rc ½"						
	12...30 V DC	0...1	2	4	4...20 mA + 2 NPN or 2 PNP ^{1.)}	Swivel 5 pin M12 male fixed connector	On request
4...20 mA					Female cable plug EN 175301-803	On request	
0...2		4	7	4...20 mA + 2 NPN or 2 PNP ^{1.)}	Swivel 5 pin M12 male fixed connector	551739 	
				4...20 mA	Female cable plug EN 175301-803	444768 	
0...5		10	12	4...20 mA + 2 NPN or 2 PNP ^{1.)}	Swivel 5 pin M12 male fixed connector	551740 	
				4...20 mA	Female cable plug EN 175301-803	444769 	
0...10		20	25	4...20 mA + 2 NPN or 2 PNP ^{1.)}	Swivel 5 pin M12 male fixed connector	551741 	
				4...20 mA	Female cable plug EN 175301-803	444770 	
0...20		40	50	4...20 mA + 2 NPN or 2 PNP ^{1.)}	Swivel 5 pin M12 male fixed connector	551742 	
				4...20 mA	Female cable plug EN 175301-803	551737 	
0...50		100	20	4...20 mA + 2 NPN or 2 PNP ^{1.)}	Swivel 5 pin M12 male fixed connector	551743 	
				4...20 mA	Female cable plug EN 175301-803	551738 	

1.) PNP standard, can be change in NPN with jumpers on electronic board

Switch version

Operating voltage	Nominal pressure range	Pressure max. [bar]	Burst pressure [bar]	Output signal	Electrical connection	Article no.	
	[bar]						
Sensor connection G ½"							
12...30 V DC	0...2	4	7	NPN / PNP	Swivel 5 pin M12 male fixed connector	439908	
				Relay NO/NC	Swivel 5 pin M12 male fixed connector + Female cable plug EN 175301-803	439911	
	0...5	10	12	NPN / PNP	Swivel 5 pin M12 male fixed connector	439920	
				Relay NO/NC	Swivel 5 pin M12 male fixed connector + Female cable plug EN 175301-803	439923	
	0...10	20	25	NPN / PNP	Swivel 5 pin M12 male fixed connector	439932	
				Relay NO/NC	Swivel 5 pin M12 male fixed connector + Female cable plug EN 175301-803	439935	
	0...20	40	50	NPN / PNP	Swivel 5 pin M12 male fixed connector	439944	
				Relay NO/NC	Swivel 5 pin M12 male fixed connector + Female cable plug EN 175301-803	439947	
	0...50	100	20	NPN / PNP	Swivel 5 pin M12 male fixed connector	439956	
				Relay NO/NC	Swivel 5 pin M12 male fixed connector + Female cable plug EN 175301-803	439959	
	Sensor connection NPT ½"						
	12...30 V DC	0...2	4	7	NPN / PNP	Swivel 5 pin M12 male fixed connector	439916
Relay NO/NC					Swivel 5 pin M12 male fixed connector + Female cable plug EN 175301-803	439919	
0...5		10	12	NPN / PNP	Swivel 5 pin M12 male fixed connector	439928	
				Relay NO/NC	Swivel 5 pin M12 male fixed connector + Female cable plug EN 175301-803	439931	
0...10		20	25	NPN / PNP	Swivel 5 pin M12 male fixed connector	439940	
				Relay NO/NC	Swivel 5 pin M12 male fixed connector + Female cable plug EN 175301-803	439943	
0...20		40	50	NPN / PNP	Swivel 5 pin M12 male fixed connector	439952	
				Relay NO/NC	Swivel 5 pin M12 male fixed connector + Female cable plug EN 175301-803	439955	
0...50		100	20	NPN / PNP	Swivel 5 pin M12 male fixed connector	439964	
				Relay NO/NC	Swivel 5 pin M12 male fixed connector + Female cable plug EN 175301-803	439967	
Sensor connection Rc ½"							
12...30 V DC		0...2	4	7	NPN / PNP	Swivel 5 pin M12 male fixed connector	439912
	Relay NO/NC				Swivel 5 pin M12 male fixed connector + Female cable plug EN 175301-803	439915	
	0...5	10	12	NPN / PNP	Swivel 5 pin M12 male fixed connector	439924	
				Relay NO/NC	Swivel 5 pin M12 male fixed connector + Female cable plug EN 175301-803	439927	
	0...10	20	25	NPN / PNP	Swivel 5 pin M12 male fixed connector	439936	
				Relay NO/NC	Swivel 5 pin M12 male fixed connector + Female cable plug EN 175301-803	439939	
	0...20	40	50	NPN / PNP	Swivel 5 pin M12 male fixed connector	439948	
				Relay NO/NC	Swivel 5 pin M12 male fixed connector + Female cable plug EN 175301-803	439951	
	0...50	100	20	NPN / PNP	Swivel 5 pin M12 male fixed connector	439960	
				Relay NO/NC	Swivel 5 pin M12 male fixed connector + Female cable plug EN 175301-803	439963	

6.4. Ordering chart accessories

Description	Article no.
5 pin M12 female straight cable plug with plastic threaded locking ring, to be wired	917116 ☒
5 pin M12 female straight cable plug moulded on cable (2 m, shielded)	438680 ☒
Female cable plug EN 175301-803 with cable gland - see Type 2518 ▶	572264 ☒
Female cable plug EN 175301-803 with NPT ½" reduction without cable gland - see Type 2509 ▶	162673 ☒