



Diaphragm valve 2/2-way servo-assisted

- Servo- assisted diaphragm valve with a diameter up to DN 20
- Media separated
- Body material in brass, stainless steel and plastic
- Circuit function NC or NO

Product variants described in the data sheet may differ from the product presentation and description.

Can be combined with



Type 2516

Cable plug,
form C according to
DIN EN 175301 - 803

Type description

Type 6212 is a servo-assisted 2/2-way valve with a servo-diaphragm. The actuator is separated from the medium by diaphragm allowing the use with slightly aggressive media. The body offering includes brass, stainless steel and plastic. The valve has a low power consumption, has a low weight and a compact design. The special design and geometry of the inner parts result in a soft closing function with very low pressure peaks.



Table of contents

1. General technical data	3
2. Circuit functions	3
3. Approvals and conformities	4
3.1. General notes.....	4
3.2. Conformity	4
3.3. Standards.....	4
3.4. Drinking water.....	4
4. Materials	5
4.1. Bürkert resistApp	5
4.2. Material specifications	5
5. Dimensions	6
5.1. Standard version with brass body or stainless steel body	6
5.2. Standard version with plastic body.....	7
6. Ordering information	8
6.1. Bürkert eShop.....	8
6.2. Bürkert product filter.....	8
6.3. Bürkert Product Enquiry Form	8
6.4. Ordering chart.....	9
Standard version with brass body	9
Standard version with stainless steel body.....	10
Standard version with plastic body PPE/PA.....	11
6.5. Ordering chart accessories.....	12
Three-part connection set made of PPE/PA.....	12
Cable plug Type 2516, form C according to DIN EN 175301 - 803.....	12

DTS 1000011052 EN Version: | Status: RL (released | freigegeben | validé) printed: 15.05.2024

1. General technical data

Product properties	
Dimensions	Further information can be found in chapter "5. Dimensions" on page 6 .
Material	
Seal	NBR, EPDM, FKM
Pilot flange body	PPS
Body	Brass, stainless steel, PPE/PA
Housing cover	Stainless steel, PPE/PA
Orifice	DN 10...DN 20
Circuit function	A and B Further information can be found in chapter "2. Circuit functions" on page 3.
Performance data	
Duty cycle	100 % continuous operation (with 24 V/DC) 40 %, 20 min. intermittent duty (with 110...120 V/UC, 230...240 V/UC)
Switching time ¹⁾	Opening: 0.1...0.5 sec Closing: 0.2...2.2 sec
Electrical data	
Operating voltage	24 V/DC (further voltages on request)
Power consumption	3.4 W 110...120 V/UC, 230...240 V/UC: 4 W
Voltage tolerance	± 10 %
Medium data	
Operating medium	Neutral and slightly aggressive, gaseous and liquid mediums that do not attack the housing and sealing materials. Further information can be found in chapter "4.1. Bürkert resistApp" on page 5 .
Medium temperature	
With NBR	0 °C...+50 °C
With EPDM	-10 °C...+50 °C
With FKM	0 °C...+50 °C
Viscosity	Max. 21 mm ² /s
Process/Port connection & communication	
Electrical connection	Plug contacts according to DIN EN 175301 -803 form C for cable plug Type 2516 ▶. (Plug contact sideways at 24 V/DC, plug contact above at 110/230 V/UC, see "5. Dimensions" on page 6)
Port connections	G ¼ ...G 1 (NPT on request) Threaded sockets G ¾, G ½ (with PPE/PA housing) Further information can be found in chapter "Three-part connection set made of PPE/PA" on page 12.
Approvals and conformities	
Degree of protection	IP65 with cable plug
Environment and installation	
Installation position	As required, preferably with actuator upright
Ambient temperature	Max. +55 °C (with PPE/PA housing +50 °C)

1.) Measurement at +20 °C, 6 bar at the valve outlet, opening: pressure build-up 0...90 %, closing: pressure reduction 100...10 %

2. Circuit functions

Symbol	Description
	Circuit function A (CF A) 2/2-way solenoid valve Servo-controlled Normally closed
	Circuit function B (CF B) 2/2-way solenoid valve Servo-controlled Normally open

3. Approvals and conformities

3.1. General notes

- The approvals and conformities listed below must be stated when making enquiries. This is the only way to ensure that the product complies with all required specifications.
- Not all available versions can be supplied with the below mentioned approvals or conformities.

3.2. Conformity

In accordance with the Declaration of Conformity, the product is compliant with the EU Directives.

3.3. Standards

The applied standards which are used to demonstrate compliance with the EU Directives are listed in the EU-Type Examination Certificate and/or the EU Declaration of Conformity.

3.4. Drinking water

Conformity	Description
	<p>Suitable for use in drinking water applications (valid for nominal diameter 13) The materials comply with the assessment principles (UBA) for materials in contact with drinking water (TrinkwasserV).</p> <p>PF36: Suitable for products with a maximum temperature of 60 °C (warm water)</p>

4. Materials

4.1. Bürkert resistApp



Bürkert resistApp – Chemical resistance chart

You want to ensure the reliability and durability of the materials in your individual application case? Verify your combination of media and materials on our website or in our resistApp.

[Start chemical resistance check](#)

4.2. Material specifications

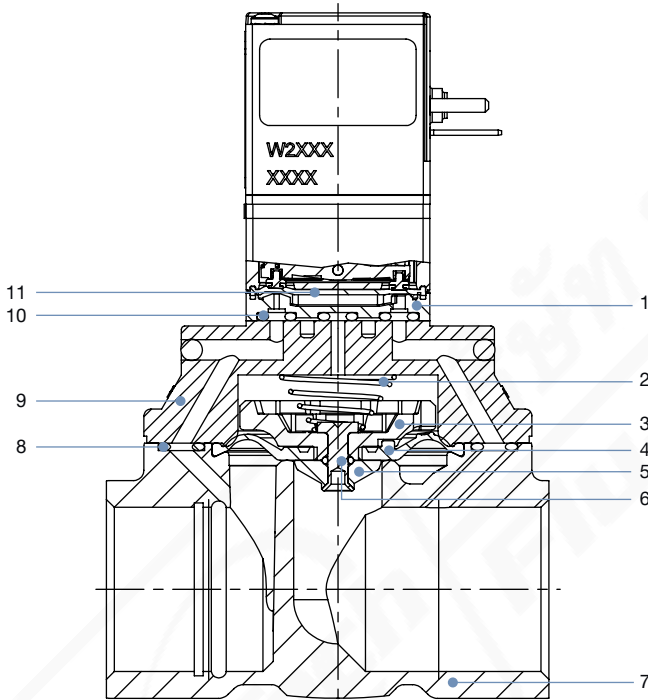

No.	Element	Material
1	Flange body	PPS
2	Pressure spring	Stainless steel 1.4310
3	Diaphragm support	PPS
4	Diaphragm	NBR, FKM or EPDM
5	Diaphragm holder	PPS
6	Bolt	Brass or stainless steel
7	Valve body	Brass, stainless steel or PPE/PA
8	O-ring	FKM or EPDM
9	Cover	Stainless steel or PPE/PA
10	O-ring	NBR, FKM or EPDM
11	Separating diaphragm	FKM or EPDM

5. Dimensions

5.1. Standard version with brass body or stainless steel body

Note:

Dimensions in mm

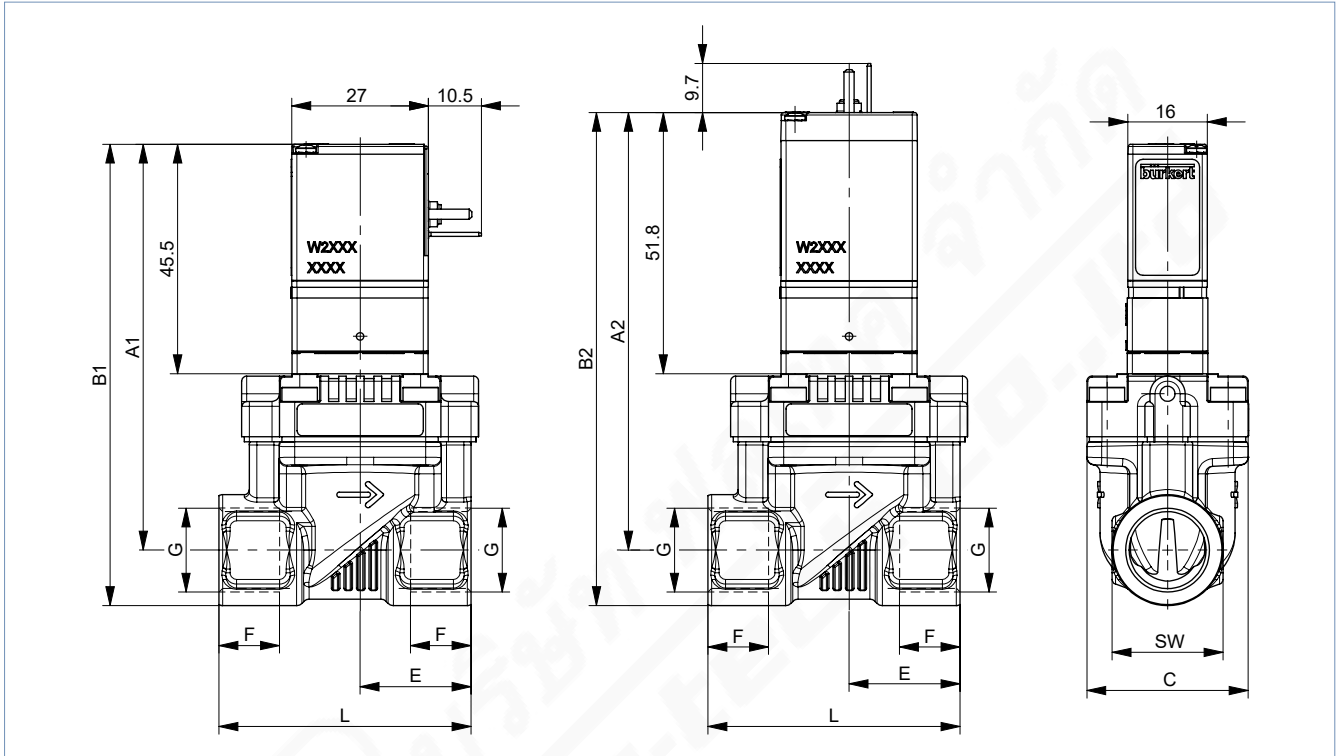

DN	G	Tag connectors sideways		Tag connectors above		C	E	F	L	SW
		A1	B1	A2	B2					
10	G ¼	80.5	91.5	86.8	97.8	32	22	12	50	22
10	G ⅜	80.5	91.5	86.8	97.8	32	22	12	50	22
10 ^{1.)}	G ½	82.5	96	88.8	102.3	32	24.5	14	50	27
10 ^{2.)}	G ½	82.5	96	88.8	102.3	32	24.5	14	55	27
13	G ½	85	98.5	91.3	104.8	42	32.5	14	65	27
13	G ¾	87	103	93.3	109.3	42	32.5	16	65	32
20	G ¾	94	114.5	100.3	120.8	60	50	16	100	41
20	G 1	94	114.5	100.3	120.8	60	50	18	100	41

1.) Brass version

2.) Stainless steel version

5.2. Standard version with plastic body

Note:
Dimensions in mm

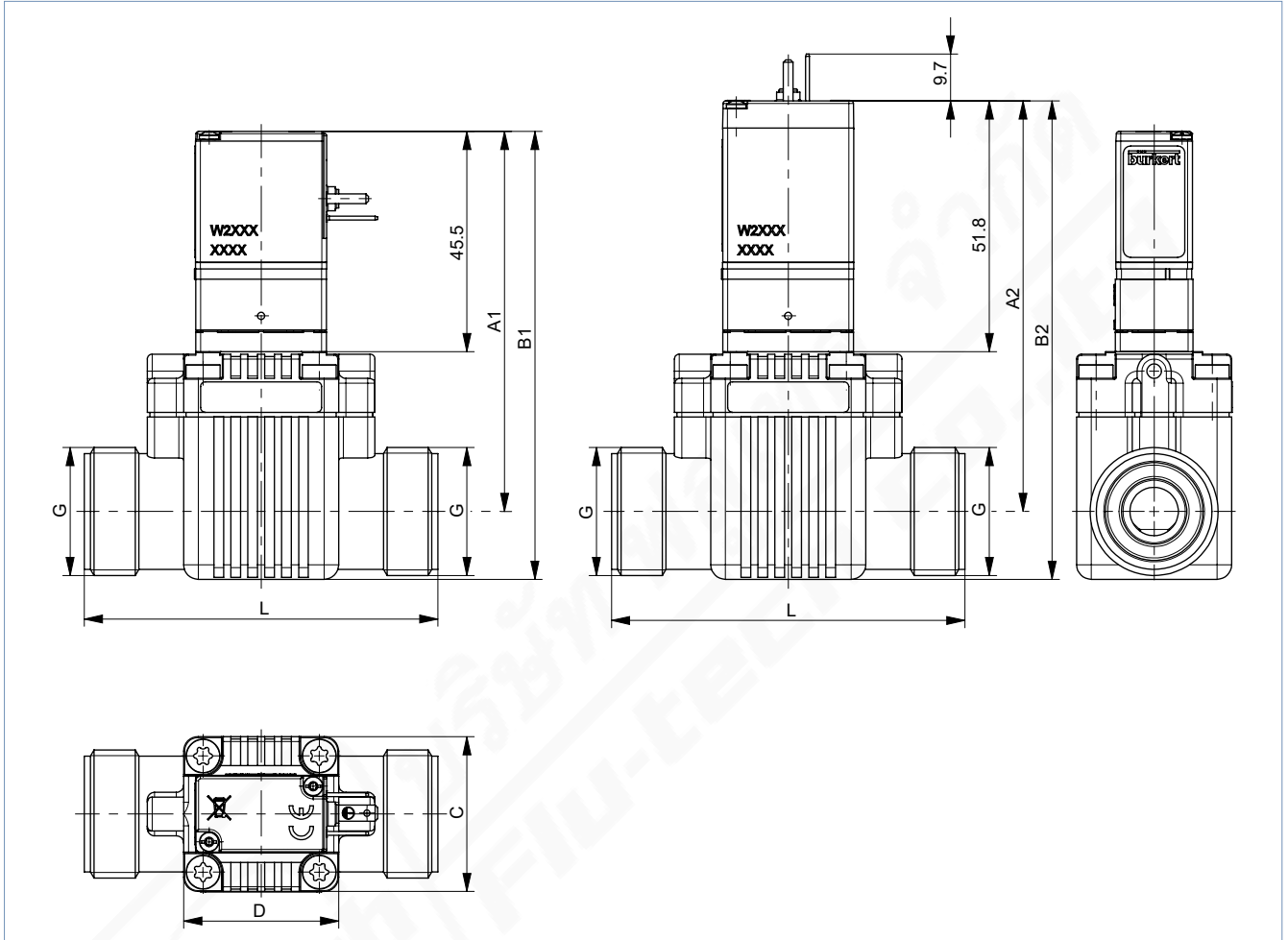

DN	G	Tag connectors sideways		Tag connectors above		C	D	L
		A1	B1	A2	B2			
10	G 3/4	78.5	92.5	84.8	98.8	32	32	73
13	G 1	85	102	91.3	108.3	43	49	85

- 1.) Brass version
- 2.) Stainless steel version

DTS 1000011052 EN Version: | Status: RL (released | freigegeben | validé) printed: 15.05.2024

6. Ordering information

6.1. Bürkert eShop



Bürkert eShop – Easy ordering and quick delivery

You want to find your desired Bürkert product or spare part quickly and order directly? Our online shop is available for you 24/7. Sign up and enjoy all the benefits.

[Order online now](#)

6.2. Bürkert product filter

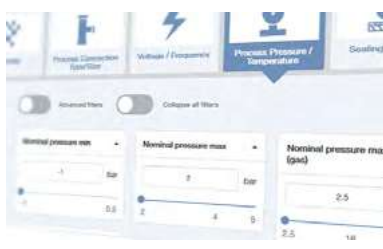

Bürkert product filter – Get quickly to the right product

You want to select products comfortably based on your technical requirements? Use the Bürkert product filter and find suitable articles for your application quickly and easily.

[Try out our product filter](#)

6.3. Bürkert Product Enquiry Form

Note:

Please see our Product Enquiry Form for a full explanation of our specification key.

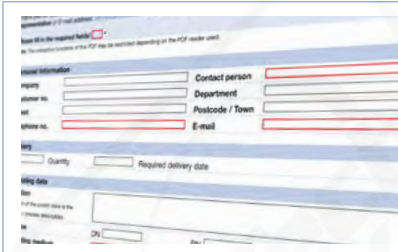

Bürkert Product Enquiry Form – Your enquiry quickly and compactly

Would you like to make a specific product enquiry based on your technical requirements? Use our Product Enquiry Form for this purpose. There you will find all the relevant information for your Bürkert contact. This will enable us to provide you with the best possible advice.

[Fill out the form now](#)

DTS 1000011052 EN Version: | Status: RL (released | freigegeben | validé) printed: 15.05.2024

6.4. Ordering chart

Standard version with brass body

Note:

- Please note that the cable plug must be ordered separately, see “6.5. Ordering chart accessories” on page 12 or separate data sheet **Type 2516** ▶.
- The electrical connection is located on the side.
- Available on request: 110...120 or 230...240 V coils with integrated rectifier and a varistor. They are therefore suitable for direct and alternating current. Only use cable plug without electronics assembly for this version.

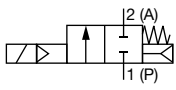
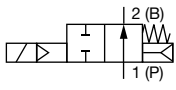
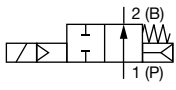
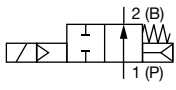
Circuit function	Port connection	Orifice	K _v value water ^{1.)}	Voltage/frequency	Pressure range ^{2.)}	Weight	Article no. NBR seal	Article no. FKM seal	Article no. EPDM seal					
		[mm]	[m ³ /h]	[V/Hz]	[bar]	[kg]								
Brass body, cover material PPE/PA, different sealing materials														
CF A 2/2-way solenoid valve Servo-controlled Normally closed 	G 3/8	10	1.9	024/DC	0.2...10 ^{3.)}	0.21	20083626	20083628	20083629					
	G 1/2					0.24	20083631	o. r.	o. r.					
		G 1/2	13	3.6	024/DC	0.2...10 ^{3.)}	0.29	138956	138959	138962				
		G 3/4					0.33	138968	138971	o. r.				
		G 3/4					20	8.3	024/DC	0.2...10 ^{3.)}	1.03	138980	138983	o. r.
		G 1									0.85	138992	138995	138998
CF B 2/2-way solenoid valve Servo-controlled Normally open 	G 3/8	10	1.9	024/DC	0.2...6 ^{3.)}	0.21	20083635	o. r.	20083636					
	G 1/2					0.24	20083638	o. r.	o. r.					
		G 1/2	13	3.6	024/DC	0.2...6 ^{3.)}	0.29	139622	139625	o. r.				
		G 3/4					0.33	o. r.	o. r.	o. r.				
		G 3/4					20	8.3	024/DC	0.2...6 ^{3.)}	1.03	139642	139645	o. r.
		G 1									0.85	139652	o. r.	o. r.

o. r. = on request

1.) Measurement at +20 °C, 1 bar^{2.)} at the valve inlet and free outlet

2.) Pressure data: overpressure to atmospheric pressure

3.) A differential pressure of 0.5 bar is required to open the full cross section.

DTS 1000011052 EN Version: I Status: RL (released | freigegeben | validé) printed: 15.05.2024



Standard version with stainless steel body

Note:

- Please note that the cable plug must be ordered separately, see “6.5. Ordering chart accessories” on page 12 or separate data sheet **Type 2516** ▶.
- The electrical connection is located on the side.
- Available on request: 110...120 or 230...240 V coils with integrated rectifier and a varistor. They are therefore suitable for direct and alternating current. Only use cable plug without electronics assembly for this version.

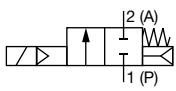
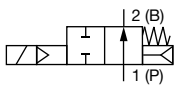
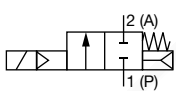
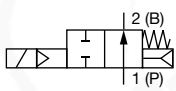
Circuit function	Port connection	Orifice	K _v value water ^{1.)}	Voltage/frequency	Pressure range ^{2.)}	Weight	Article no. NBR seal	Article no. FKM seal	Article no. EPDM seal
		[mm]	[m ³ /h]	[V/Hz]	[bar]	[kg]			
Stainless steel body, cover material stainless steel, different sealing materials									
CF A 2/2-way solenoid valve Servo-controlled Normally closed 	G 3/8	10	1.9	024/DC	0.2...10 ^{3.)}	0.27	o. r.	20083633	20083642
	G 1/2					0.28	o. r.	139582	140673
	G 1/2	13	3.6	024/DC	0.2...10 ^{3.)}	0.38	o. r.	139586	140677
	G 3/4					0.41	o. r.	o. r.	140681
	G 3/4	20	8.3	024/DC	0.2...10 ^{3.)}	1.12	o. r.	139594	140685
	G 1					1.20	o. r.	139598	140689
CF B 2/2-way solenoid valve Servo-controlled Normally open 	G 3/8	10	1.9	024/DC	0.2...6 ^{3.)}	0.27	o. r.	20083641	20083645
	G 1/2					0.28	o. r.	139666	o. r.
	G 1/2	13	3.6	024/DC	0.2...6 ^{3.)}	0.38	o. r.	139670	140719
	G 3/4					0.41	o. r.	o. r.	140723
	G 3/4	20	8.3	024/DC	0.2...6 ^{3.)}	1.12	o. r.	139678	140727
	G 1					1.20	o. r.	o. r.	140731
Stainless steel body, cover material PA/PPE, different sealing materials									
CF A 2/2-way solenoid valve Servo-controlled Normally closed 	G 3/8	10	1.9	024/DC	0.2...10 ^{3.)}	0.22	20083643	o. r.	o. r.
	G 1/2					0.26	140696	o. r.	o. r.
	G 1/2	13	3.6	024/DC	0.2...10 ^{3.)}	0.28	140699	o. r.	o. r.
	G 3/4					0.34	140702	o. r.	o. r.
	G 3/4	20	8.3	024/DC	0.2...10 ^{3.)}	1.03	140705	o. r.	o. r.
	G 1					0.85	140708	180234	o. r.
CF B 2/2-way solenoid valve Servo-controlled Normally open 	G 3/8	10	1.9	024/DC	0.2...6 ^{3.)}	0.22	20083646	o. r.	o. r.
	G 1/2					0.26	140738	o. r.	o. r.
	G 1/2	13	3.6	024/DC	0.2...6 ^{3.)}	0.28	140741	o. r.	o. r.
	G 3/4					0.34	140744	o. r.	o. r.
	G 3/4	20	8.3	024/DC	0.2...6 ^{3.)}	1.03	140748	o. r.	o. r.
	G 1					0.85	140751	o. r.	o. r.

o. r. = on request

1.) Measurement at +20 °C, 1 bar^{2.)} at the valve inlet and free outlet

2.) Pressure data: overpressure to atmospheric pressure

3.) A differential pressure of 0.5 bar is required to open the full cross section.

DTS 1000011052 EN Version: | Status: RL (released | freigegeben | validé) printed: 15.05.2024

Standard version with plastic body PPE/PA

Note:

- Please note that the cable plug must be ordered separately, see “6.5. Ordering chart accessories” on page 12 or separate data sheet **Type 2516** ▶.
- The electrical connection is located on the side.
- Available on request: 110...120 or 230...240 V coils with integrated rectifier and a varistor. They are therefore suitable for direct and alternating current. Only use cable plug without electronics assembly for this version.
- All valves are supplied with PPE/PA body and without connection set (see “Three-part connection set made of PPE/PA” on page 12).

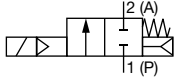
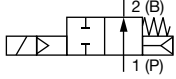
Circuit function	Port connection	Orifice	K _v value water ^{1.)}	Voltage/frequency	Pressure range ^{2.)}	Weight	Article no. NBR seal	Article no. FKM seal	Article no. EPDM seal
		[mm]	[m ³ /h]	[V/Hz]	[bar]	[kg]			
Plastic body PPE/PA, cover material PPE/PA, different sealing materials									
CF A 2/2-way solenoid valve Servo-controlled Normally closed 	G 3/8	10	1.8	024/DC	0.2...10 ^{3.)}	0.12	20083653	20083654	o. r.
	G 1/2	13	3.6	024/DC	0.2...10 ^{3.)}	0.14	20083657	20083658	o. r.
CF B 2/2-way solenoid valve Servo-controlled Normally open 	G 3/8	10	1.8	024/DC	0.2...6 ^{3.)}	0.12	20083655	20083656	o. r.
	G 1/2	13	3.6	024/DC	0.2...6 ^{3.)}	0.14	20083659	20083660	o. r.

o. r. = on request
 1.) Measurement at +20 °C, 1 bar^{2.)} at the valve inlet and free outlet
 2.) Pressure data: overpressure to atmospheric pressure
 3.) A differential pressure of 0.5 bar is required to open the full cross section.

Further versions on request	
Voltage Non standard voltages, 110...120 V, 230...240 V	Port connection NPT

DTS 1000011052 EN Version: | Status: RL (released | freigegeben | validé) printed: 15.05.2024

6.5. Ordering chart accessories

Three-part connection set made of PPE/PA

Note:

- You need two connection sets for one valve.
- The connection set is not included in the delivery and must be ordered separately.

Accessories	Port connection	Orifice	Seal material	Article no.
		[mm]	(O-ring)	
	G 3/8	10	NBR	142425
			FPM	142426
			EPDM	142427
	G 1/2	13	NBR	142428
			FPM	142429
			EPDM	142430

Cable plug Type 2516, form C according to DIN EN 175301 - 803

Note:

- Dimensions in mm
- Delivery of cable plug includes a flat seal and a fixing screw.
- For further versions see data sheet **Type 2516** ▶.

Cable plug	Dimensions	Version	Voltage	Article no.
		Without circuitry	0...250 V AC/DC	303141
		With LED	12...24 V AC/DC	303145
		With LED and varistor	12...24 V AC/DC	303148
		With rectifier, LED and varistor	12...24 V AC/DC	303142

DTS 1000011052 EN Version: | Status: RL (released | freigegeben | validé) printed: 15.05.2024