

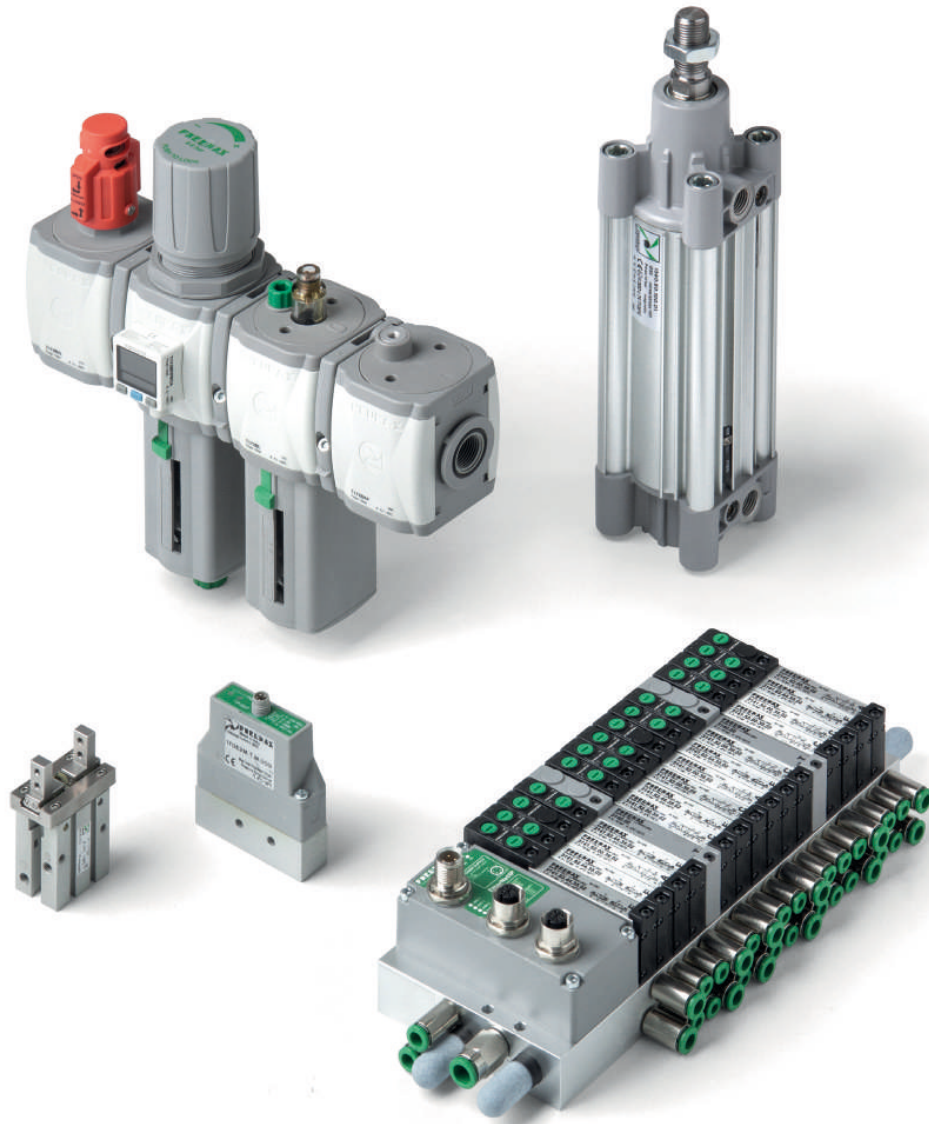

PNEUMAX



GENERAL CATALOGUE 2021

SOLUTIONS FOR PNEUMATIC AUTOMATION

FLU-TECH CO. LTD.

Email: sales@flutech.co.th **Website:** https://flutech.co.th

Tel: 02-384-6060, 086-369-5871-3 **Fax:** 02-384-5701 **LINE OA:** @flutech.co.th

Address (HQ): 845/3-4, Moo 3, Theparak Rd., T. Theparak, A. Mueang Samut Prakan, Samut Prakan, 10270, Thailand





Series 1319-1320-1321

General

This series of pneumatic cylinders is manufactured according to ISO 6431 standards adapted to VDMA 24562 and CNOMO/AFNOR 49003 that guarantee the interchangeability of the cylinders even without mounted anchoring.

Construction characteristics

End caps	from Ø32 to Ø125: UNI 5079 aluminium alloy casting painted black by cataphoresis from Ø160 to Ø200: UNI 3051 aluminium chilled painted black by cataphoresis
Rod	stainless steel or C43 chromed steel
Barrel	oxidised aluminium
Cushion bushings	hardened aluminium
Rod-guide bushing	self-lubricating sintered bronze
Piston	vulcanized rubber block on steel core with incorporated plastoferrite permanent magnet, or without magnet for non magnetic version (plus rear spacer).
Seals	standard: NBR Oil resistant rubber, PUR Piston rod and cushion seals (FPM seals available upon request)
Cushion adjustment screws	brass

Operational characteristics

Fluid	Filtered air. No lubrication needed, if applied it shall be continuous.
Pressure	max. 10 bar
Operating temperature	-5 °C - +70 °C with standard seals (magnetic or non magnetic piston) -5 °C - +80 °C with FPM seals for 1319 and 1320 series (magnetic piston) -5 °C - +150 °C with FPM seals for 1321 series (non magnetic piston)
Cushioning length	Ø 32 - 40 - 50 - 63 - 80 - 100 - 125 - 160 - 200 mm 28 - 32 - 32 - 40 - 44 - 50 - 55 - 55 - 55

Please follow the suggestions below to ensure a long life for these cylinders:

- use clean and lubricated air
- correct alignment during assembly with regard to the applied load so as to avoid radial components or bending the rod.
- avoid high speeds together with long strokes and heavy loads: this would produce kinetic energy which the cylinder cannot absorb, especially if used as a limit stop (in this case use mechanical stop device)
- evaluate the environmental characteristics of cylinder used (high temperature, hard atmosphere, dust, humidity etc.)

Please note: air must be dried for applications with lower temperature.

Use hydraulic oils H class (ISO VG32) for correct continued lubrication.

Our Technical Department will be glad to help.

Standard strokes (for all diameters)

Double acting version

from 0 to 150, every 25 mm
over 150 up to 500, every 50 mm
over 500 up to 1000, every 100 mm

On request are available strokes up to 2800 mm

Single acting version

From Ø32 to Ø125, up to stroke 50 mm

On request are available strokes up to 200 mm

Stroke tolerance (ISO 15552)

Bore	Stroke	Tolerance
32 - 40 - 50	up to 500	+2 0
	over 500 up to 1250	+3,2 0
63 - 80 - 100	up to 500	+2,5 0
	over 500 up to 1250	+4 0
125 - 160 - 200	up to 500	+4 0
	over 500 up to 1250	+5 0

Minimum and maximum springs load for single acting version

Bore	Ø32	Ø40	Ø50 - Ø63	Ø80 - Ø100	Ø125
Min. load (N)	15	25	50	100	150
Max. load (N)	40	80	115	200	250

► **Basic version "01"**

Ordering code
1319.Ø.stroke.01 magnetic chromed rod
1320.Ø.stroke.01 magnetic stainless steel rod
1321.Ø.stroke.01 non magnetic chromed rod
13--Ø.stroke.01V FPM seals
13--Ø.stroke.01MA Front springs (Ø32-Ø125)*
13--Ø.stroke.01MP Rear springs (Ø32-Ø125)*

* Max. stroke 50

This is the configuration that represents the basic cylinder according to ISO-VDMA standards. It can be directly anchored on machine parts using the four thread on the end cap. For other applications see the following pages where different types of attachments are shown.

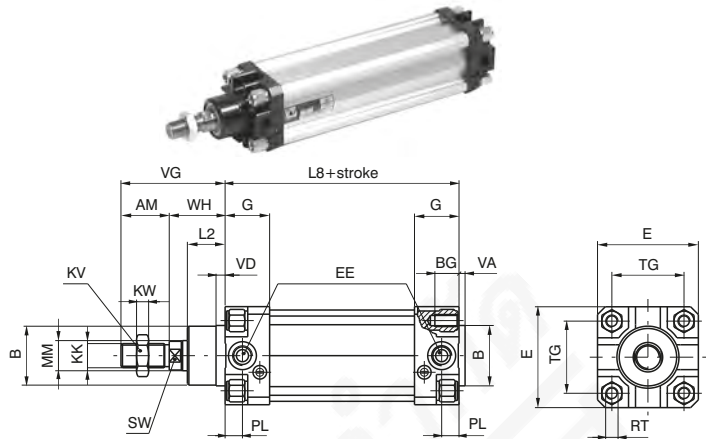

► **Through rod cylinder version "02"**

Ordering code
1319.Ø.stroke.02 magnetic chromed rod
1320.Ø.stroke.02 magnetic stainless steel rod
1321.Ø.stroke.02 non magnetic chromed rod
13--Ø.stroke.02V FPM seals

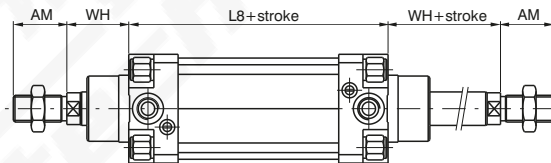

► **Tandem push with a common rods "G"**

Ordering code
1319.Ø.stroke.G magnetic chromed rod
1320.Ø.stroke.G magnetic stainless steel rod
1321.Ø.stroke.G non magnetic chromed rod

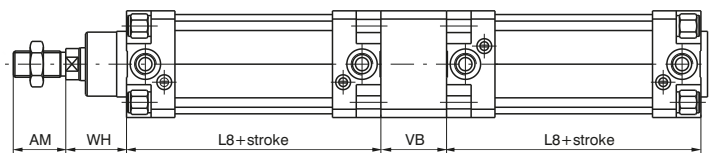

► **Tandem push with independent rods "F"**

Ordering code
1319.Ø.stroke.stroke1.F magnetic chromed rod
1320.Ø.stroke.stroke1.F magnetic stainless steel rod
1321.Ø.stroke.stroke1.F non magnetic chromed rod

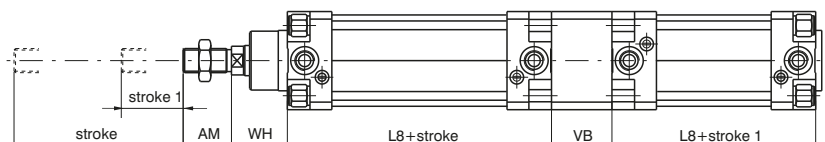

► **Opposed tandem with common rod "D"**

Ordering code

1319.Ø.stroke.stroke1.D magnetic chromed rod
1320.Ø.stroke.stroke1.D magnetic stainless steel rod
1321.Ø.stroke.stroke1.D non magnetic chromed rod

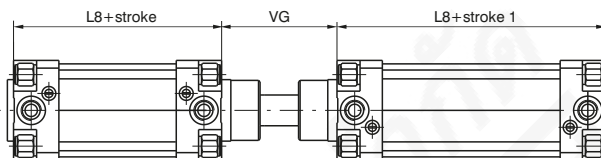

► **Tandem with opposed rods "E"**

Ordering code

1319.Ø.stroke.stroke1.E magnetic chromed rod
1320.Ø.stroke.stroke1.E magnetic stainless steel rod
1321.Ø.stroke.stroke1.E non magnetic chromed rod

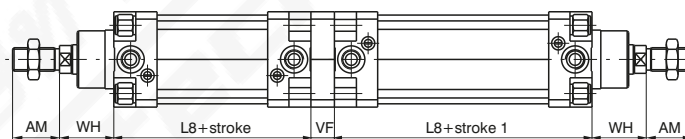

Table of dimensions

Bore	32	40	50	63	80	100	125	160	200	
AM	22	24	32	32	40	40	54	72	72	
B (d 11)	30	35	40	45	45	55	60	65	75	
BG	14	14	16	16	21	21	23	24	24	
E	46	52	65	75	95	115	140	180	220	
EE	G 1/8"	G 1/4"	G 1/4"	G 3/8"	G 3/8"	G 1/2"	G 1/2"	G 3/4"	G 3/4"	
G	25	29	29,5	36	36	40	45	49	49	
KK	M10X1,25	M12X1,25	M16x1,5	M16x1,5	M20x1,5	M20x1,5	M27x2	M36x2	M36x2	
KV	17	19	24	24	30	30	41	55	55	
KW	6	7	8	8	9	9	12	18	18	
L2	16	20	25	25	32	35	45	50	60	
L8 *	94	105	106	121	128	138	160	180	180	
MM	12	16	20	20	25	25	32	40	40	
PL	9	11,5	13	14	16	18	19	24	25	
RT	M6	M6	M8	M8	M10	M10	M12	M16	M16	
SW	10	13	17	17	22	22	27	32	32	
TG	32,5	38	46,5	56,5	72	89	110	140	175	
VA	4	4	4	4	4	4	6	5	5	
VB	25	30	40	40	50	50	75	70	75	
VD	5	6	6	6	10	10	12	10	10	
VF	12	12	16	16	20	20	25	30	30	
VG	48	54	69	69	86	91	119	152	167	
WH	26	30	37	37	46	51	65	80	95	
Weight g	Stroke 0	480	730	1150	1600	2800	3600	7800	15000	21500
	every 10 mm	25	32	56	60	90	100	140	265	325

* For strokes over 50mm, the length does not increase proportionally to the stroke, and allowance must be made for adequate spring allocation (see table of L8 dimensions).

"L8" dimensions for "rear spring" and "front spring"

Bore	32	40	50	63	80	100	125
L8 (Stroke 51 ÷ 100)	134	150	151	166	183	193	230
L8 (Stroke 101 ÷ 150)	174	195	196	211	238	248	300
L8 (Stroke 151 ÷ 200)	214	240	241	256	293	303	370