



## Air preparation units

- Modular configuration
- Compact design
- Simple mounting
- Relieving

Product variants described in the data sheet may differ from the product presentation and description.

## Type description

The service equipment for compressed air is configured as required for each of the following individual devices:

- Filter drain
- Diaphragm pressure regulator
- Micro lubricator
- Pressure gauge
- Shut off valve
- Soft Start valve
- Stop valve
- Fine filter
- Activated carbon filter

## Table of contents

<b>1. General technical data</b>	<b>3</b>
<b>2. Ordering information</b>	<b>4</b>
2.1. Bürkert eShop – Easy ordering and quick delivery.....	4
2.2. Bürkert product filter.....	4
2.3. Ordering chart.....	4
Filter regulator.....	4
Micro lubricator.....	5
Filter 5 µm.....	5
Fine filter 0.01 µm.....	5
Activated carbon filter.....	6
Diaphragm pressure regulator.....	6
Diaphragm pressure regulator with continuous pressure supply.....	6
Diaphragm precision pressure regulator.....	7
Diaphragm precision pressure regulator with continuous pressure supply.....	7
3/2 way control valve.....	7
Soft start valve.....	8
Shut-off ball valve.....	8
Distributor.....	8
Non return valve.....	9
Bowl (Polycarbonate).....	9
Metal bowl.....	9
Mounting bracket for control panel mounting, steel galvanised.....	10
Control panel nut.....	10
Mounting bracket for wall mount with 2x screw 3 x 10 with Torx 10IP, steel galvanised.....	11
Coupling kit.....	11
Coupling kit for wall mounting.....	12
Fastening set with process connection.....	12
Replacement filters.....	12
2.4. Ordering chart accessories.....	12
Bourdon tube pressure gauge, 0...12 bar, 160 psi, TAU001.....	12

DTS 1000194817 EN Version: | Status: RL (released | freigegeben | validé) printed: 18.03.2020

## 1. General technical data

### Note:

Other versions on request

Product properties	
Dimensions	Detailed information can be found in the corresponding ordering table in the chapter "2. Ordering information" on page 4.
Material	
Body	Plastic: Grivory GV-6H with 60 % glass fibre
Size	
0	Connection 1/8" and 1/4"
1	Connection 1/4" and 3/8"
2	Connection 3/8" and 1/2"
4	Connection 3/4" and 1"
Standard filter sizes	
Filter regulator	5 µm
Filter	5 µm
Fine filter	0.01 µm, remaining oil content <0.01 mg/m <sup>3</sup>
Activated carbon filter	Remaining oil content <0.005 mg/m <sup>3</sup>
Performance data	
Max. supply pressure	
Size 0	12 barg
Size 1, 2, 4	16 barg
Control range	0.5...10 bar
Medium data	
Type of medium	Compressed air, neutral gases
Media temperature	0...+50 °C at 10 barg
Approvals and certificates	
ATEX	All equipment with size 1, 2 and 4 except electrically operated valves: <ul style="list-style-type: none"> <li>• Zone 2, Category 3G, EX-group IIA, IIB and IIC</li> <li>• Zone 22, Category 3D</li> <li>• Zone 1, Category 2G, EX-group IIA, IIB and IIC</li> <li>• Zone 21, Category 2D, EX-group IIIA and IIIB</li> <li>• Zone 22, Category 3D, EX-group IIIA and IIIB</li> </ul>
Product connections	
Process connection	
Size 0...1/8", 1, 2, 4	Zinc die-cast
Size 0...1/4"	Plastic: Grivory GV-6H with 60 % glass fibre
Environment and installation	
Ambient temperature	0...+50 °C

## 2. Ordering information

### 2.1. Bürkert eShop – Easy ordering and quick delivery



**Bürkert eShop – Easy ordering and fast delivery**

You want to find your desired Bürkert product or spare part quickly and order directly? Our online shop is available for you 24/7. Sign up and enjoy all the benefits.

[Order online now](#)

### 2.2. Bürkert product filter



**Bürkert product filter – Get quickly to the right product**

You want to select products comfortably based on your technical requirements? Use the Bürkert product filter and find suitable articles for your application quickly and easily.

[Try out our product filter](#)

### 2.3. Ordering chart

#### Filter regulator

Without pressure gauge and mounting parts

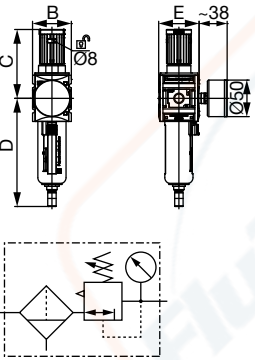

Size	Port size	B	C	D	E	Q <sub>max</sub> at P=6.3 bar and Δp=1 bar	Article no.			
							[mm]	[mm]	[mm]	[mm]
0	1/8"	43.0	63.0	105.0	48.0	1000	771919	772193	n/a	n/a
0	1/4"	43.0	63.0	105.0	48.0	1000	771920	772194	n/a	n/a
1	1/4"	52.0	95.5	129.5	54.0	2200	771921	772195	772723	772729
1	3/8"	52.0	95.5	129.5	54.0	2600	771922	772196	n/a	n/a
2	3/8"	63.0	110.0	147.0	67.0	4300	771923	772197	n/a	n/a
2	1/2"	63.0	110.0	147.0	67.0	5200	771924	772110	772726	772732
4	3/4"	85.0	137.0	192.0	93.0	14000	771925	772198	772727	772733
4	1"	85.0	137.0	192.0	93.0	14000	771926	772199	772728	772734

**Micro lubricator**

Oil type CL 32, acc. to DIN 51517 - ISO VG 32

Size	Port size	B	C	D	E	Q <sub>max</sub> at P=6 bar and Δp= 1 bar	Tank capacity lubricator	Article no. G-threaded connection
		[mm]	[mm]	[mm]	[mm]			
0	1/8"	43.0	58.0	98.0	48.0	1400	35	771927
0	1/4"	43.0	58.0	98.0	48.0	1400	35	771928
1	1/4"	52.0	62.5	123.0	54.0	2800	40	771929
1	3/8"	52.0	62.5	123.0	54.0	2800	40	771930
2	3/8"	63.0	69.7	137.5	67.0	8000	80	771931
2	1/2"	63.0	69.7	137.5	67.0	8000	80	771932
4	3/4"	85.0	87.9	182.8	93.0	13000	181	771933
4	1"	85.0	87.9	182.8	93.0	13000	181	771934

**Filter 5 μm**

Size	Port size	B	C	D	E	Q <sub>max</sub> at P=6 bar and Δp= 1 bar	Article no.	
							G-threaded connection with half auto. condensate drain	G-threaded connection with auto. condensate drain
		[mm]	[mm]	[mm]	[mm]	[l/min]		
0	1/8"	43.0	27.0	105.0	48.0	950	771935	772200
0	1/4"	43.0	27.0	105.0	48.0	950	771936	772201
1	1/4"	52.0	34.0	130.0	54.0	2200	771937	772202
1	3/8"	52.0	34.0	130.0	54.0	2400	771938	772203
2	3/8"	63.0	42.5	147.0	67.0	3500	771939	772204
2	1/2"	63.0	42.5	147.0	67.0	3500	771940	772205
4	3/4"	85.0	58.0	192.0	93.0	8000	771941	772206
4	1"	85.0	58.0	192.0	93.0	8200	771942	772207

**Fine filter 0.01 μm**

With semi-automatic condensate drain

Size	Port size	B	C	D	E	Q <sub>max</sub> at P=6 bar and Δp= 1 bar	Article no. G-threaded connection
		[mm]	[mm]	[mm]	[mm]		
0	1/8"	43.0	27.0	105.0	48.0	350	771943
0	1/4"	43.0	27.0	105.0	48.0	350	771944
1	1/4"	52.0	38.0	130.5	54.0	350	771945
1	3/8"	52.0	38.0	130.5	54.0	350	771946
2	3/8"	63.0	48.0	147.0	67.0	500	771947
2	1/2"	63.0	48.0	147.0	67.0	500	771948
4	3/4"	85.0	63.0	192.0	93.0	1500	771949
4	1"	85.0	63.0	192.0	93.0	1500	771950

**Activated carbon filter**

Remaining oil content <0.005 mg/m<sup>3</sup>

Size	Port size	B	C	D	E	Q <sub>max</sub> at P=6 bar and Δp=1 bar [l/min]	Article no. G-threaded connection
		[mm]	[mm]	[mm]	[mm]		
0	1/8"	43.0	27.0	98.0	48.0	600	771951
0	1/4"	43.0	27.0	98.0	48.0	600	771952
1	1/4"	52.0	34.0	124.0	54.0	650	771953
1	3/8"	52.0	34.0	124.0	54.0	650	771954
2	3/8"	63.0	43.0	141.0	67.0	1300	771955
2	1/2"	63.0	43.0	141.0	67.0	1300	771956
4	3/4"	85.0	58.0	184.0	93.0	2000	771957
4	1"	85.0	58.0	184.0	93.0	2000	771958

**Diaphragm pressure regulator**

Without pressure gauge and mounting parts

Size	Port size	B	C	D	E	Q <sub>max</sub> at P=6.3 bar and Δp=1 bar [l/min]	Article no. G-threaded connection
		[mm]	[mm]	[mm]	[mm]		
<b>Size 0, 1, 2 without air consumption</b>							
0	1/8"	43.0	63.0	25.0	48.0	1000	771959
0	1/4"	43.0	63.0	25.0	48.0	1000	771960
1	1/4"	52.0	95.5	33.0	54.0	2200	771961
1	3/8"	52.0	95.5	33.0	54.0	2600	771962
2	3/8"	63.0	110.0	39.5	67.0	4300	771963
2	1/2"	63.0	110.0	39.5	67.0	5100	771964
<b>Size 4 with air consumption max. 1.5 l/min</b>							
4	3/4"	85.0	137.0	54.0	93.0	14000	771965
4	1"	85.0	137.0	54.0	93.0	14000	771966

**Diaphragm pressure regulator with continuous pressure supply**

Without pressure gauge and mounting parts

Size	Port size	B	C	D	E	Q <sub>max</sub> at P=6.3 bar and Δp=1 bar [l/min]	Article no. G-threaded connection
		[mm]	[mm]	[mm]	[mm]		
0	1/4"	43.0	68.0	25.0	48.0	1000	771967
1	1/4"	52.0	95.5	32.5	54.0	2200	771968
1	3/8"	52.0	95.5	32.5	54.0	2600	771969
2	3/8"	63.0	110.0	39.5	67.0	4300	771970
2	1/2"	63.0	110.0	39.5	67.0	5000	771971

DTS 1000194817 EN Version: | Status: RL (released | freigegeben | valide) printed: 18.03.2020

**Diaphragm precision pressure regulator**

Without pressure gauge and mounting parts, with air consumption 2.6 l/min at P2=6 bar

Size	Port size	B	C	D	E	Q <sub>max</sub> at P=6.3 bar and Δp= 1 bar	Article no. G-threaded connection
		[mm]	[mm]	[mm]	[mm]		
1	1/4"	52.0	95.5	33.0	54.0	2200	771972
1	3/8"	52.0	95.5	33.0	54.0	2700	771973
2	3/8"	63.0	110.0	39.5	67.0	4300	771974
2	1/2"	63.0	110.0	39.5	67.0	5000	771975

**Diaphragm precision pressure regulator with continuous pressure supply**

Without pressure gauge and mounting parts, with air consumption 2.6 l/min at P2=6 bar

Size	Port size	B	C	D	E	Q <sub>max</sub> at P=6.3 bar and Δp= 1 bar	Article no. G-threaded connection
		[mm]	[mm]	[mm]	[mm]		
1	1/4"	52.0	95.5	32.5	54.0	2200	771976
1	3/8"	52.0	95.5	32.5	54.0	2700	771977
2	3/8"	63.0	110.0	39.5	67.0	4300	771978
2	1/2"	63.0	110.0	39.5	67.0	5000	771979

**3/2 way control valve**

Electric operated (not ATEX)

Size	Port size	B	C	D	E	Q <sub>max</sub> at P=6 bar and Δp= 1 bar	Article no. 24 V DC	Article no. 230 V AC
		[mm]	[mm]	[mm]	[mm]			
0	1/8"	43.0	93.0	36.6	48.0	2000	771980	771988
0	1/4"	43.0	93.0	36.6	48.0	2000	771981	771989
1	1/4"	52.0	84.5	32.8	54.0	2000	771982	771990
1	3/8"	52.0	84.5	32.8	54.0	2000	771983	771991
2	3/8"	63.0	93.5	56.5	67.0	4300	771984	771992
2	1/2"	63.0	93.5	56.5	67.0	4300	771985	771993
4	3/4"	85.0	110.9	102.3	93.0	12500	771986	771994
4	1"	85.0	110.9	102.3	93.0	12500	771987	771995

Size	Port size	B	C	D	E	Q <sub>max</sub> at P=6 bar and Δp= 1 bar	Article no.
		[mm]	[mm]	[mm]	[mm]		
0	1/8"	43.0	60.1	36.6	48.0	2000	772000
0	1/4"	43.0	60.1	36.6	48.0	2000	772001
1	1/4"	52.0	52.0	33.0	54.0	2000	772002
1	3/8"	52.0	52.0	33.0	54.0	2000	772003
2	3/8"	63.0	60.8	56.5	67.0	4300	772004
2	1/2"	63.0	60.8	56.5	67.0	4300	772005
4	3/4"	85.0	78.2	67.0	93.0	12500	772006
4	1"	85.0	78.2	67.0	93.0	12500	772007

Visit product website

**Soft start valve**

Filling time adjustable

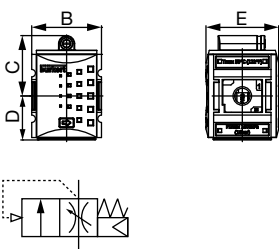

Size	Port size	B	C	D	E	Q <sub>max</sub> at P=6 bar and Δp=1 bar [l/min]	Article no. G-threaded connection
		[mm]	[mm]	[mm]	[mm]		
0	1/8"	48.0	53.0	28.0	48.0	1800	772008
0	1/4"	48.0	53.0	28.0	48.0	1800	772009
1	1/4"	52.0	45.0	33.0	54.0	1900	772010
1	3/8"	52.0	45.0	33.0	54.0	1900	772011
2	3/8"	63.0	53.5	58.0	67.0	4400	772012
2	1/2"	63.0	53.5	58.0	67.0	4400	772103
4	3/4"	85.0	58.2	54.0	93.0	10000	772014
4	1"	85.0	58.2	54.0	93.0	10000	772015

**Shut-off ball valve**

Lockable with padlock

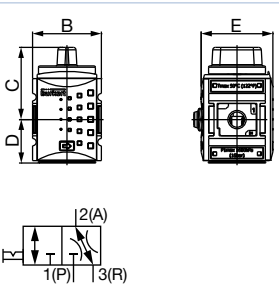

Size	Port size	B	C	D	E	Q <sub>max</sub> at P=6 bar and Δp=1 bar [l/min]	Article no. G-threaded connection
		[mm]	[mm]	[mm]	[mm]		
0	1/8"	43.0	51.0	25.0	48.0	1800	772016
0	1/4"	43.0	51.0	25.0	48.0	1800	772017
1	1/4"	52.0	54.3	33.0	54.0	1900	772018
1	3/8"	52.0	54.3	33.0	54.0	1900	772019
2	3/8"	63.0	70.5	56.5	67.0	5000	772020
2	1/2"	63.0	70.5	56.5	67.0	5000	772021
4	3/4"	85.0	93.7	51.0	93.0	14000	772022
4	1"	85.0	93.7	51.0	93.0	14000	772023

**Distributor**

Size	Port size	Top outlet	Front outlet	Bottom outlet
0	1/4"	1/4"	–	1/4"
0	1/4"	1/4"	–	1/4"
1	1/4"	1/4"	1/4"	1/4"
1	3/8"	1/4"	1/4"	1/4"
2	3/8"	1/4"	3/8"	1/2"
2	1/2"	1/4"	3/8"	1/2"
4	3/4"	3/4"	–	3/4"
4	1"	3/4"	–	3/4"

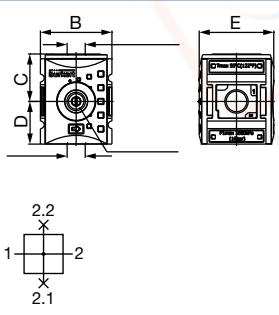





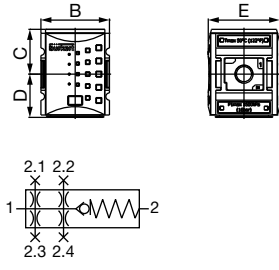

Size	Port size	B	C	D	E	Q <sub>max</sub> at P=6 bar (1→2) and Δp=1 bar [l/min]	Article no. G-threaded connection
		[mm]	[mm]	[mm]	[mm]		
0	1/8"	43.0	28.5	25.0	48.0	2700	772024
0	1/4"	43.0	28.5	25.0	48.0	2700	772025
1	1/4"	52.0	34.5	31.0	54.0	2700	772026
1	3/8"	52.0	54.3	31.0	54.0	3600	772027
2	3/8"	63.0	70.5	37.5	67.0	7250	772028
2	1/2"	63.0	70.5	37.5	67.0	7250	772029
4	3/4"	85.0	93.7	51.0	93.0	18000	772030
4	1"	85.0	93.7	51.0	93.0	18000	772031



























## Non return valve



























Size	Port size	B	C	D	E	Q <sub>max</sub> at P=6 bar (1→2) and Δp=1 bar [l/min]	Article no.
		[mm]	[mm]	[mm]	[mm]		
0	1/8"	43.0	27.0	39.0	48.0	800	772032 
0	1/4"	43.0	27.0	39.0	48.0	800	772033 
1	1/4"	52.0	34.0	33.0	54.0	1250	772034 
1	3/8"	52.0	34.0	33.0	54.0	1250	772035 
2	3/8"	63.0	43.0	37.5	67.0	4500	772036 
2	1/2"	63.0	43.0	37.5	67.0	4500	772037 

## Bowl (Polycarbonate)

Size	Port size	Article no. oil bowl	Article no. with automatic drain	Article no. with semi-automatic drain
0	1/8"	772046 	771778 	772042 
0	1/4"	772046 	771778 	772042 
1	1/4"	772047 	771779 	772043 
1	3/8"	772047 	771779 	772043 
2	3/8"	772048 	772040 	772044 
2	1/2"	772048 	772040 	772044 
4	3/4"	772049 	772041 	772045 
4	1"	772049 	772041 	772045 

## Metal bowl

Size	Port size	Article no. oil bowl	Article no. with automatic drain	Article no. with semi-automatic drain
0	1/8"	772058 	772050 	772054 
0	1/4"	772058 	772050 	772054 
1	1/4"	772059 	772051 	772055 
1	3/8"	772059 	772051 	772055 
2	3/8"	772060 	772052 	772056 
2	1/2"	772060 	772052 	772056 
4	3/4"	772061 	772053 	772057 
4	1"	772061 	772053 	772057 

Mounting bracket for control panel mounting, steel galvanised

Size 0

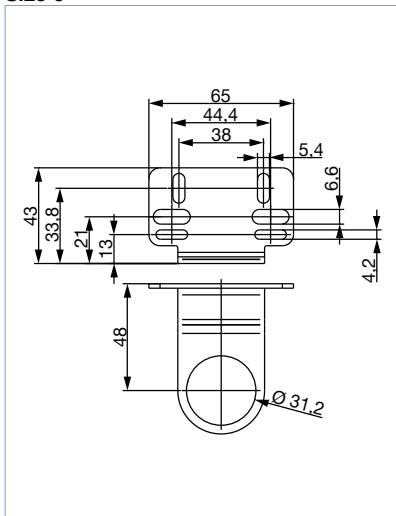

<b>Article no.</b>
772062

Size 1

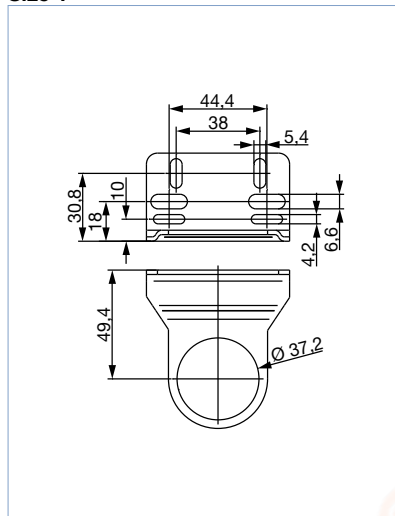

<b>Article no.</b>
772063

Size 2

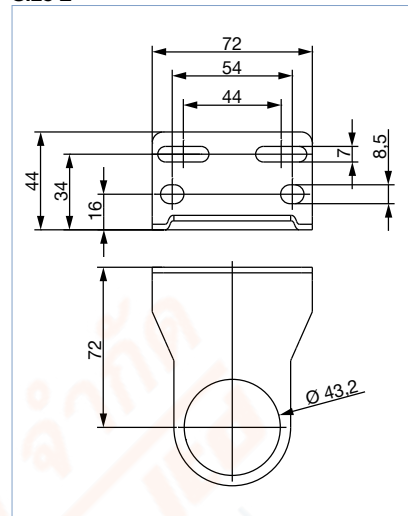

<b>Article no.</b>
772064

Control panel nut

Size	Thread	Material	Article no.
0	M30 × 1.5	POM	772065
1	M36 × 1.5	POM+GF	772066
2	M42 × 1.5	POM+GF	772067

DTS 1000194817 EN Version: | Status: RL (released | freigegeben | validé) printed: 18.03.2020

Mounting bracket for wall mount with 2x screw 3 x 10 with Torx 10IP, steel galvanised

Size 0

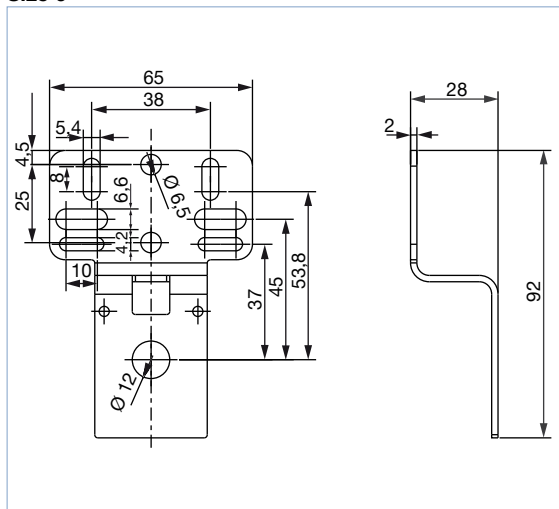

Size 1

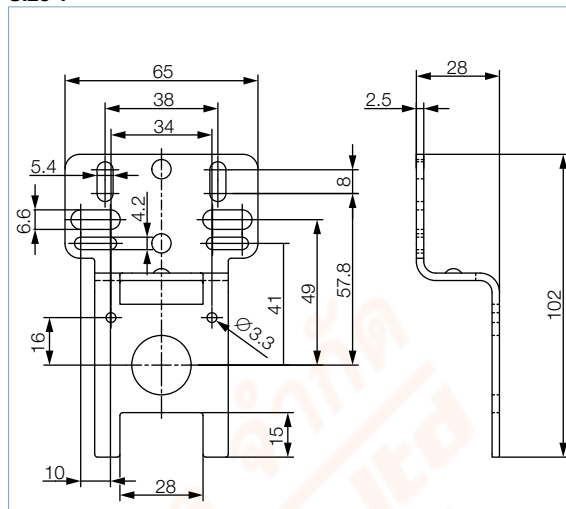

Size 2

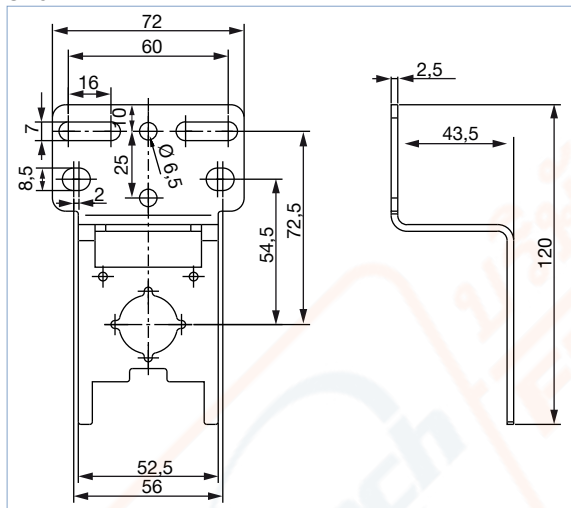

Size 4

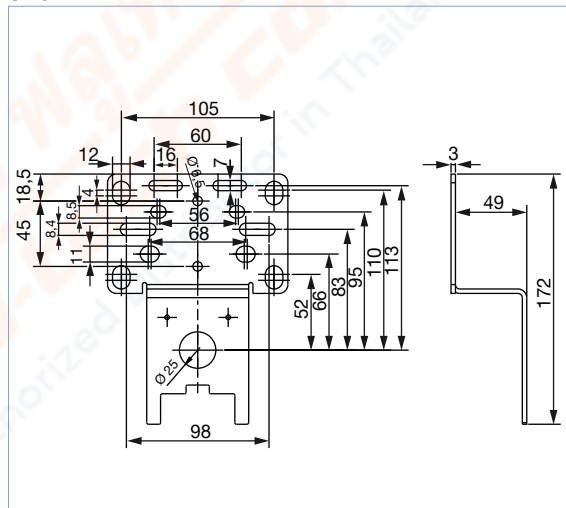





Size	Article no.
0	772068 𠄎
1	772069 𠄎
2	772070 𠄎
4	772071 𠄎

Coupling kit







Size	Article no.
0	772072 𠄎
1	772073 𠄎
2	772074 𠄎
4	772075 𠄎



## Coupling kit for wall mounting

	Size	Article no.
	0	772076 
	1	772077 
	2	772078 
	4	772079 

## Fastening set with process connection





	Size	Port size	Article no. G-threaded connection	Article no. NPT-threaded connection
	1	¼"	774069 	774072 
	2	½"	774070 	774073 
	4	1"	774071 	774074 

## Replacement filters

Size	Article no. Filter 5 µm	Article no. Filter 0.01 µm	Article no. Activated carbon filter
0	772080 	772085 	772089 
1	772080 	772084 	772088 
2	772082 	772086 	772090 
4	772083 	772087 	772091 

## 2.4. Ordering chart accessories

## Bourdon tube pressure gauge, 0...12 bar, 160 psi, TAU001

	Version	Size	Article no.
	Ø 40 mm, G ¼"	0	772137 
	Ø 50 mm, G ¼"	1.2	772138 
	Ø 50 mm, NPT ¼"	1.2	772805 
	Ø 63 mm, G ¼"	4	772139 