

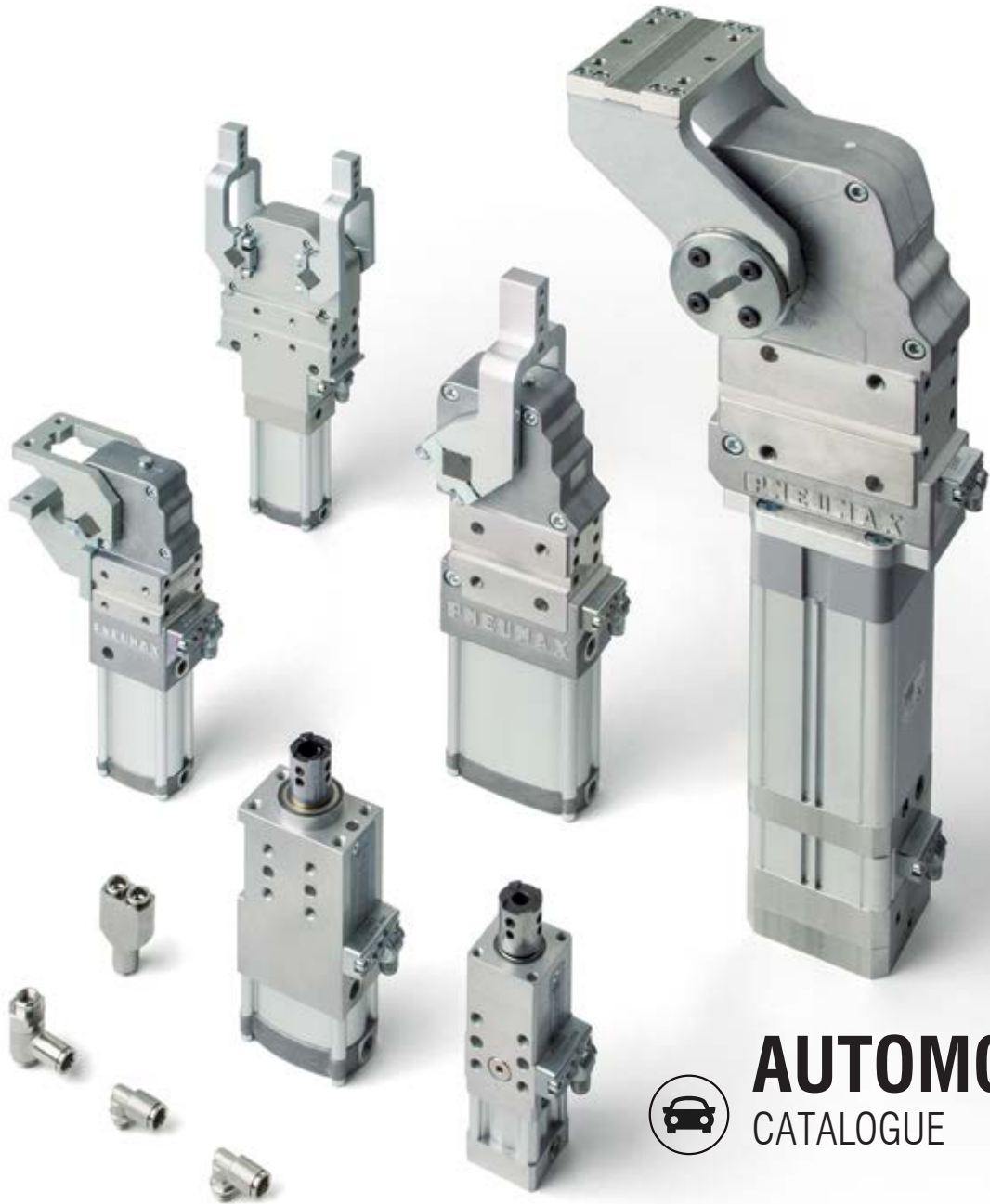

บริษัท ฟลูเทค จำกัด  
Flu-tech co.,ltd  
Authorized Distributor



**PNEUMAX**



**AUTOMOTIVE**  
CATALOGUE



WWW.FLUTECH.CO.TH



ADD FRIEND  
@flutech.co.th

FLU-TECH CO.,LTD | บริษัท ฟลูเทค จำกัด  
845/3-4 M.3 , Theparak, Muang, Samutprakan 10270  
845/3-4 หมู่ 3 ถ.เทพารักษ์ ต.เทพารักษ์ อ.เมือง จ.สมุทรปราการ 10270

# CB-Series



## Power clamp with double arm

- Stepless adjustable opening angle
- Toggle lock mechanism
- Unlock manual override > in case of air loss the clamp can be opened manually
- Pneumatic ports on both sides of the cylinder
- Extremely compact dimensions
- 4-sided mounting pattern

CLAMPING

### Technical features

**Manual release button** to open the linkage when air pressure is removed during setup. **Pneumatic ports on both sides** of the cylinder.

#### Operating features

<b>Operating pressure</b>	from 2 to 8 bar / from 30 to 115 psi
<b>Lubrication</b>	all the devices are lubricated for life at the factory. Inline air lubrication isn't required

### Functional charts

#### Size 40 mm

##### • Tooling weight chart

5 bar operating pressure – 135° opening angle  
REV. 00 - 02/12/2019

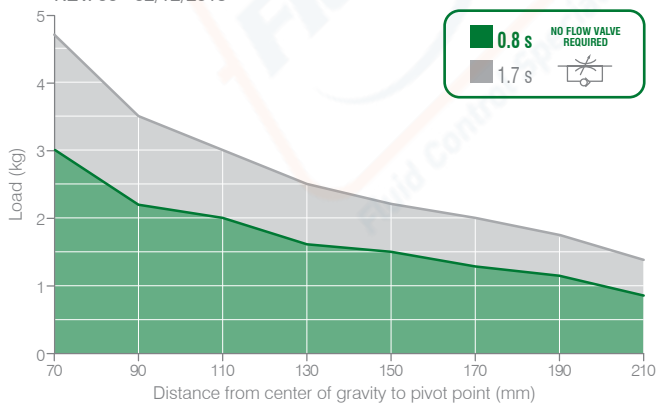

##### • Clamping moment (at 5 bar / 72.5 psi)

**85 N m / 62,69 lb-ft**

##### • Cycle time

**0.8 s at 90°**

#### Size 63 mm

##### • Tooling weight chart

5 bar operating pressure – 135° opening angle  
REV. 00 - 17/06/2015

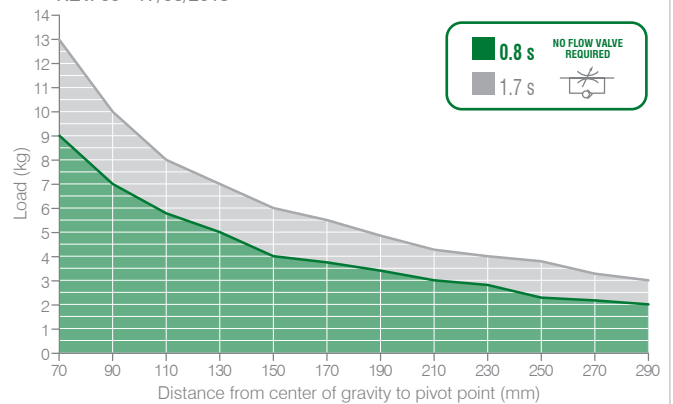

##### • Clamping moment (at 5 bar / 72.5 psi)

**170 N m / 125,39 lb-ft**

##### • Cycle time

**0.8 s at 90°**



The above data are meant for correct working conditions of the clamp with the same performance level during its life time. For applications which exceed the above data, please contact our sales representatives.

Ordering string

**CB-Series**

**CB 40 E G 5 A 01**

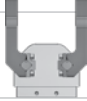
CLAMPING

<b>CB</b>	<b>VERSION</b>	<b>CB</b> = double arm clamp
<b>40</b>	<b>SIZE</b>	<b>40</b> = Ø 40 mm <b>63</b> = Ø 63 mm
<b>E</b>	<b>SENSOR</b>	<b>E</b> = electronic sensor with M12 swivel connector - PNP
<b>G</b>	<b>PORTS</b>	<b>G</b> = G thread – BSPP
<b>5</b>	<b>ARM MOUNT</b>	<b>5</b> =  <b>6</b> = 
<b>A</b>	<b>ARM MATERIAL</b>	<b>A</b> = aluminum
<b>01</b>	<b>CLAMP ARM TYPE</b>	<b>01</b> = wishbone, central, 15 mm offset <b>02</b> = wishbone, right, 15 mm offset <b>03</b> = wishbone, left, 15 mm offset <b>61</b> = wishbone, 10 mm offset specific for CB40 clamp

Stepless adjustment from 13° to 180° for size 40 mm  
Stepless adjustment from 8° to 180° for size 63 mm

**CB40EG / Power clamp with double arm - 40 mm bore**

**WEIGHT 2.5 kg**

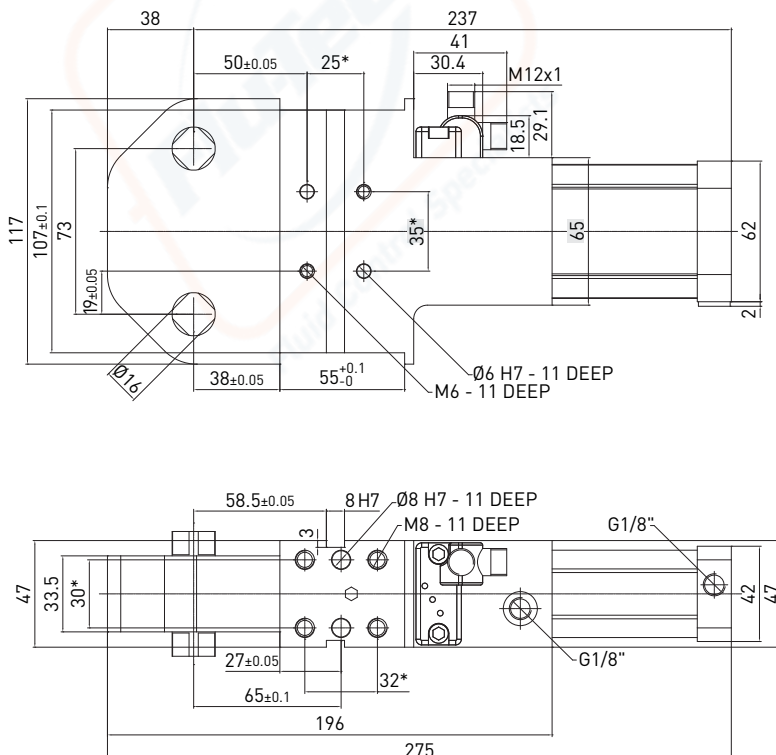

\* DIMENSIONAL TOLERANCE FOR DOWEL HOLES: ±0.02  
DIMENSIONAL TOLERANCE FOR THREADED HOLES: ±0.1

REV. 00 - 20/09/2018

## Clamping arms / 16 mm shaft

REV. 00 - 31/03/2015

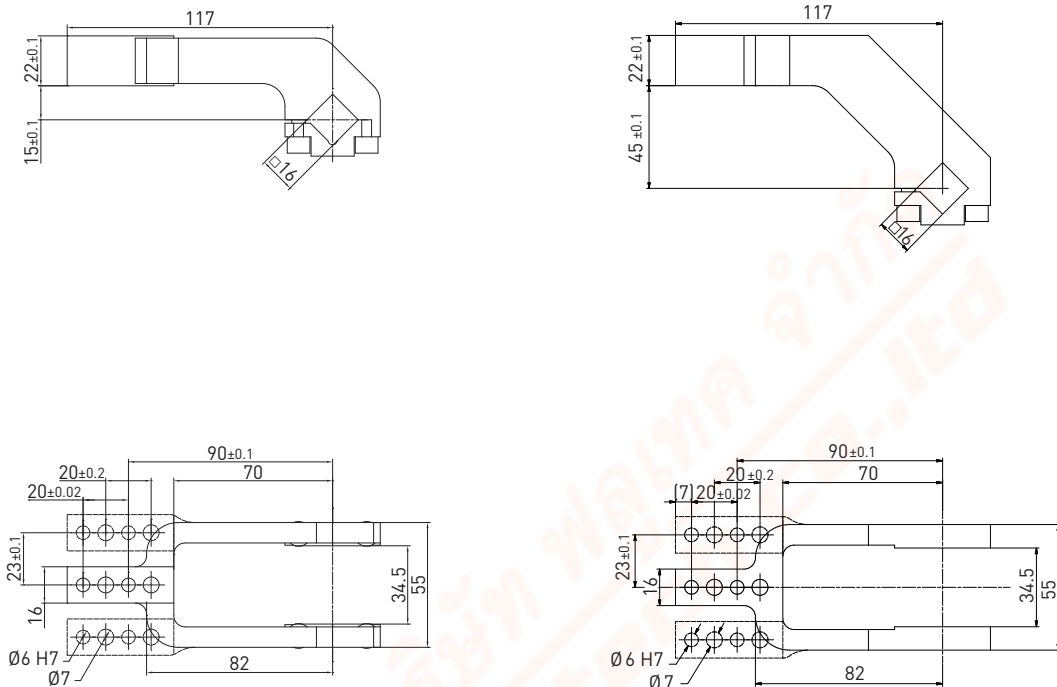

CLAMPING

### 16 mm shaft – 15 mm offset



Part no.	Material	Version	Weight (kg)	Max op. angle pos. 5
B1601	Aluminum	Central	0.24	90°
Q1601	Steel	Central	0.44	90°
B1602	Aluminum	Right	0.24	90°
Q1602	Steel	Right	0.46	90°
B1603	Aluminum	Left	0.24	90°
Q1603	Steel	Left	0.46	90°

Screws: M6x20 Tightening torque: 10 N m / 7.37 lb ft

### 16 mm shaft – 45 mm offset



Part no.	Material	Version	Weight (kg)	Max op. angle pos. 5
B1604	Aluminum	Central	0.3	90°
Q1604	Steel	Central	0.55	90°
B1605	Aluminum	Right	0.3	90°
Q1605	Steel	Right	0.57	90°
B1606	Aluminum	Left	0.3	90°
Q1606	Steel	Left	0.57	90°

Screws: M6x20 Tightening torque: 10 N m / 7.37 lb ft

**Clamping arms / 16 mm shaft - 10 mm offset - Specific for CB40 clamps**

REV. 00 - 24/09/2019

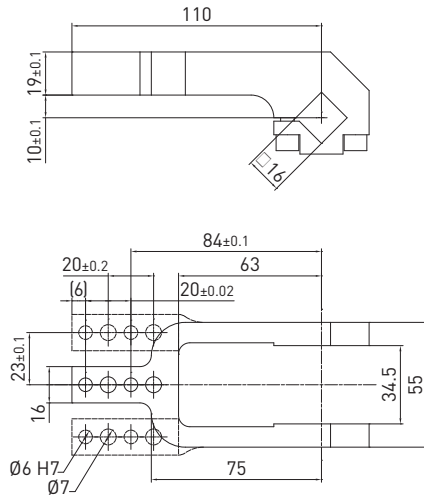

**16 mm shaft - 10 mm offset**

Part no.	Material	Version	Weight (kg)	Max op. angle pos. 5	Max op. angle pos. 6
<b>B1661</b>	<b>Aluminum</b>	<b>Central</b>	<b>0.24</b>	<b>90°</b>	<b>90°</b>

Screws: M6x25 Tightening torque: 10 N m / 7.37 lb-ft

**16 mm shaft - 0 mm offset**

Part no.	Material	Version	Weight (kg)	Max op. angle pos. 5	Max op. angle pos. 6
<b>B1618</b>	<b>Aluminum</b>	<b>Central</b>	<b>0.22</b>	<b>90°</b>	<b>90°</b>

Screws: M6x25 Tightening torque: 10 N m / 7.37 lb-ft

**WEIGHT 2.5 kg**

**CB63EG / Power clamp with double arm - 63 mm bore**

**WEIGHT 6 kg**

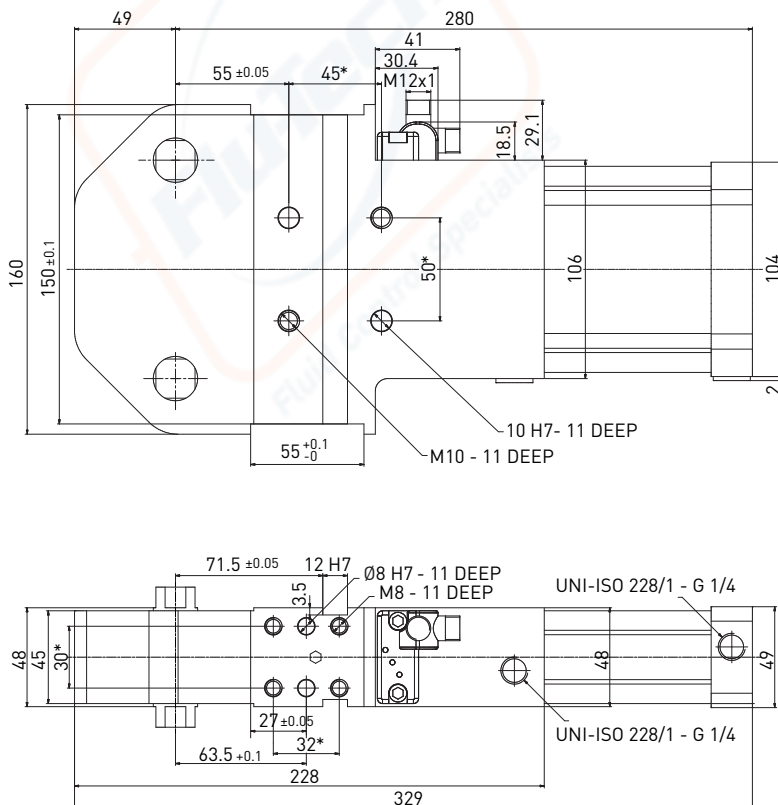

\* DIMENSIONAL TOLERANCE FOR DOWEL HOLES: ±0.02  
DIMENSIONAL TOLERANCE FOR THREADED HOLES: ±0.1

REV. 00 - 24/09/2019

## Clamping arms / 19 mm shaft

REV. 01 - 08/02/2019

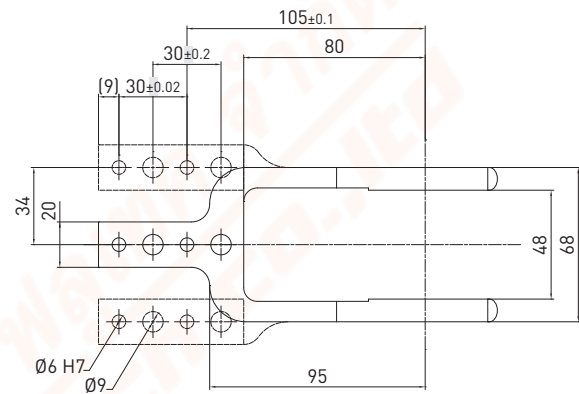
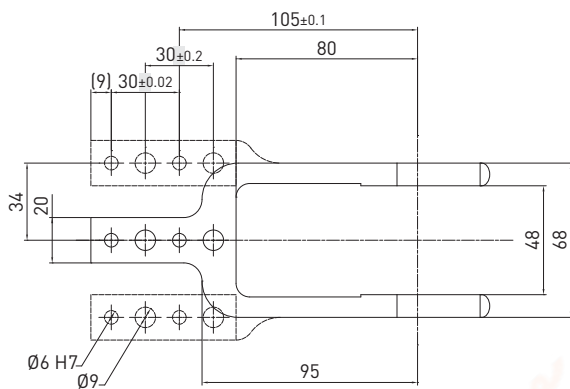
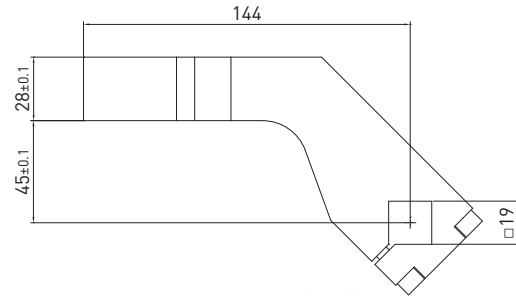
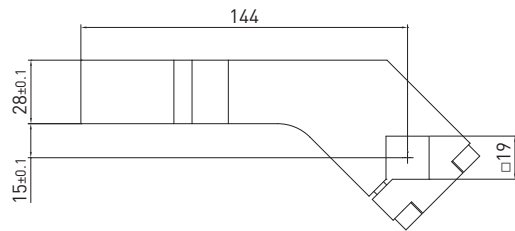

Ø 8 H7  
Mount pattern for  
B1907 - B1908 - B1909

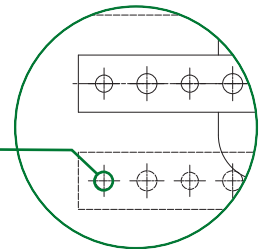

### 19 mm shaft – 15 mm offset

Part no.	Material	Version	Weight (kg)	Max op. angle pos. 5	Max op. angle pos. 6
B1901	Aluminum	Central	0.41	90°	90°
Q1901	Steel	Central	0.71	90°	90°
B1902	Aluminum	Right	0.43	90°	90°
Q1902	Steel	Right	0.79	90°	90°
B1903	Aluminum	Left	0.43	90°	90°
Q1903	Steel	Left	0.79	90°	90°
B1907	Aluminum	Central	0.41	90°	90°
B1908	Aluminum	Right	0.43	90°	90°
B1909	Aluminum	Left	0.43	90°	90°

Screws: M6x25 Tightening torque: 10 N m / 7.37 lb ft

### 19 mm shaft – 45 mm offset

Part no.	Material	Version	Weight (kg)	Max op. angle pos. 5	Max op. angle pos. 6
B1904	Aluminum	Central	0.45	90°	90°
Q1904	Steel	Central	0.77	90°	90°
B1905	Aluminum	Right	0.46	90°	90°
Q1905	Steel	Right	0.81	90°	90°
B1906	Aluminum	Left	0.46	90°	90°
Q1906	Steel	Left	0.81	90°	90°

Screws: M6x25 Tightening torque: 10 N m / 7.37 lb ft

## Clamping arms / 19 mm shaft

REV. 01 - 08/02/2019

CLAMPING

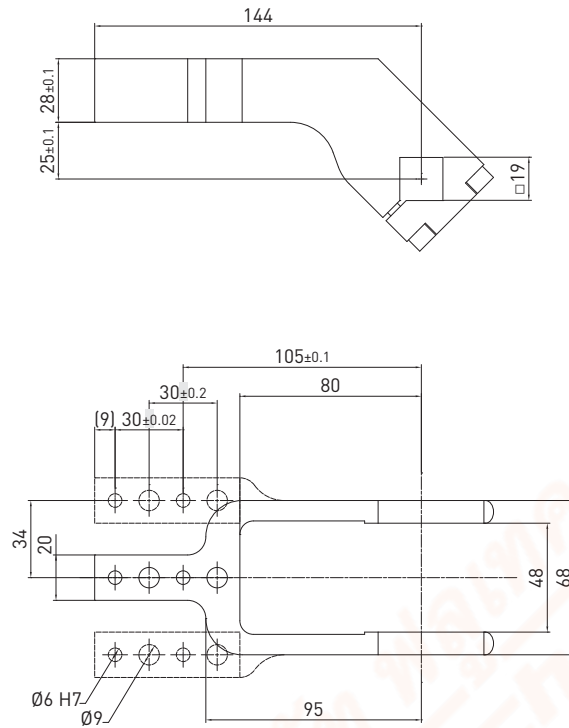

### 19 mm shaft – 25 mm offset

Part no.	Material	Version	Weight (kg)	Max op. angle pos. 5	Max op. angle pos. 6
<b>B1921</b>	<b>Aluminum</b>	<b>Central</b>	<b>0.43</b>	<b>90°</b>	<b>90°</b>
<b>B1922</b>	<b>Aluminum</b>	<b>Central</b>	<b>0.44</b>	<b>90°</b>	<b>90°</b>
<b>B1923</b>	<b>Aluminum</b>	<b>Central</b>	<b>0.44</b>	<b>90°</b>	<b>90°</b>

Screws: M6x25 Tightening torque: 10 N m / 7.37 lb ft