

Technical details

Connection	M5
Nominal size	2.5 mm
Temperature range	-10°C ... +70°C
Medium	Filtered, oil-free and dried compressed air according to ISO 8573-1:2010, Class 7:2:4, instrument air, free of aggressive additives. Differing the pressure dew point must be at least 10°C below lowest occurring ambient temperature.
Materials	Body: Al (anodized), seals: NBR, inner parts: stainless steel and brass, Stem: stainless steel

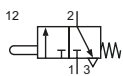

Mechanically operated seat valve including mounting adaptor for actuator mount.

3/2-way-Valves

T-25-311
3/2-way, mechanical spring return,
stem operated

Technical data

Model-no.:	T-25-311
Operating pressure (bar)	0 ... 12
Flow rate (NI/min)	95
Actuating force at 6 bar (N)	22
Actuation stroke (mm)	4
Weight (kg)	0.042

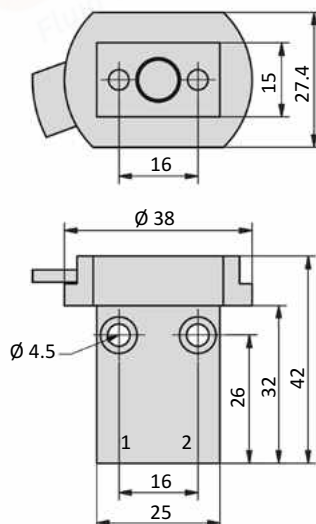
Dimensions
T-25-311

- 1 = pressure inlet
- 2 = outlets

Actuator \varnothing 22.5 mm

18-T-23-011-xx Push button

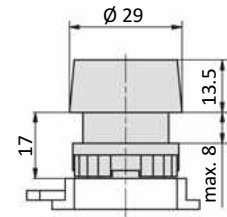

Model-no.: 18-T-23-011-xx +	T-25-311	T-28-311	T-28-511	T-30-310	T-30-510
Symbol					
Actuating force at 6 bar (N)	24	23	15	13	23
Weight (with valve) (kg)	0.057	0.073	0.090	0.067	0.091

Please complete: xx = Color (20 = green, 21 = green with white line, 30 = black, 40 = red, 42 = red with white circle, 50 = yellow, 60 = blue)

18-T-23-012-xx Mushroom

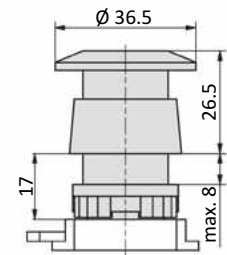

Model-no.: 18-T-23-012-xx +	T-25-311	T-28-311	T-28-511	T-30-310	T-30-510
Symbol					
Actuating force at 6 bar (N)	24	23	15	13	23
Weight (with valve) (kg)	0.062	0.078	0.095	0.072	0.096

Please complete: xx = Color (20 = green, 30 = black, 40 = red)

18-T-23-013 2 position switch

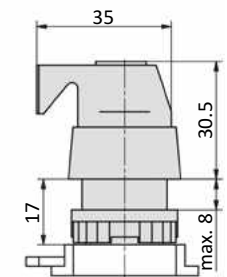

Model-no.: 18-T-23-013 +	T-25-311	T-28-311	T-28-511	T-30-310	T-30-510
Symbol					
Actuating force at 6 bar (N)	24	23	15	26	25
Weight (with valve) (kg)	0.064	0.080	0.097	0.074	0.098

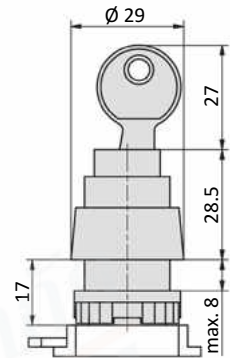
18-T-23-014 Key-return

Model-no.: 18-T-23-014 +	T-25-311	T-28-311	T-28-511	T-30-310	T-30-510
Symbol					
Actuating force at 6 bar (N)	24	23	15	13	23
Weight (with valve) (kg)	0.123	0.139	0.156	0.133	0.157

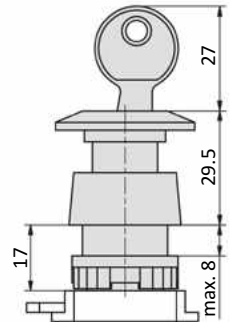
18-T-23-015 Stop, key-return

Model-no.: 18-T-23-015 +	T-25-311	T-28-311	T-28-511	T-30-310	T-30-510
Symbol					
Actuating force at 6 bar (N)	24	23	15	13	23
Weight (with valve) (kg)	0.125	0.141	0.158	0.135	0.159

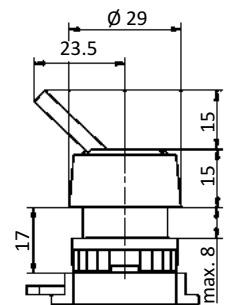
18-T-23-016 Toggle

Model-no.: 18-T-23-016 +	T-25-311	T-28-311	T-28-511	T-30-310	T-30-510
Symbol					
Actuating force at 6 bar (N)	24	23	15	26	25
Weight (with valve) (kg)	0.069	0.085	0.102	0.079	0.103

Actuator Ø 30 mm

18-T-30-011-xx Push button

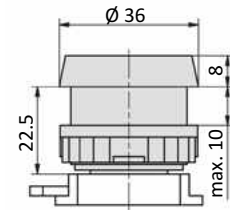

Model-no.: 18-T-30-011-xx +	T-25-311	T-28-311	T-28-511	T-30-310	T-30-510
Symbol					
Actuating force at 6 bar (N)	24	23	15	15	24
Weight (with valve) (kg)	0.066	0.082	0.099	0.076	0.100

Please complete: xx = Color (20 = green, 30 = black, 40 = red, 50 = yellow)

18-T-30-012-xx Mushroom

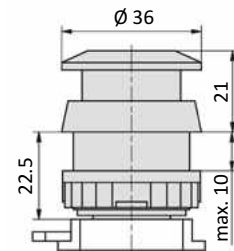

Model-no.: 18-T-30-012-xx +	T-25-311	T-28-311	T-28-511	T-30-310	T-30-510
Symbol					
Actuating force at 6 bar (N)	24	23	15	15	24
Weight (with valve) (kg)	0.071	0.087	0.104	0.081	0.105

Please complete: xx = Color (30 = black, 40 = red)

18-T-30-013 2 position switch

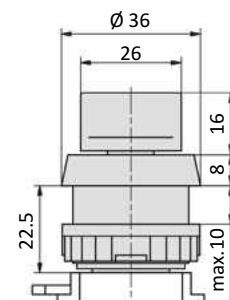

Model-no.: 18-T-30-013 +	T-25-311	T-28-311	T-28-511	T-30-310	T-30-510
Symbol					
Actuating force at 6 bar (N)	24	23	15	15	25
Weight (with valve) (kg)	0.071	0.087	0.104	0.081	0.105

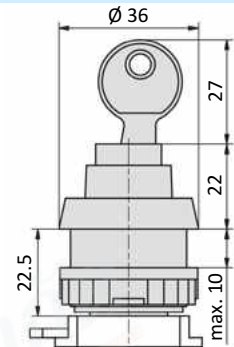
18-T-30-014 Key-return

Model-no.: 18-T-30-014 +	T-25-311	T-28-311	T-28-511	T-30-310	T-30-510
Symbol					
Actuating force at 6 bar (N)	24	23	15	15	25
Weight (with valve) (kg)	0.122	0.138	0.155	0.132	0.156

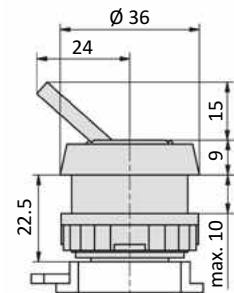
18-T-30-016 Toggle

Model-no.: 18-T-30-016 +	T-25-311	T-28-311	T-28-511	T-30-310	T-30-510
Symbol					
Actuating force at 6 bar (N)	24	23	15	9	11
Weight (with valve) (kg)	0.069	0.085	0.102	0.079	0.103

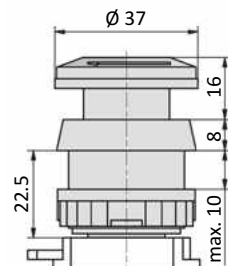
18-T-30-018 Mushroom red, detent

Model-no.: 18-T-30-018 +	T-25-311	T-28-311	T-28-511	T-30-310	T-30-510
Symbol					
Actuating force at 6 bar (N)	24	23	15	31	25
Weight (with valve) (kg)	0.077	0.093	0.110	0.087	0.111