

Serie Valves

Valvole Elettropneumatiche

Solenoid Valve
 Elektropneumatische Ventile
 Distributeurs Elettropneumatiques
 Válvulas Electroneumáticas
 Válvulas Electro-pneumáticas



Serie 01V - X1V

Pag. 18.6 - 18.16

Valvole Asservite

Assisted Valve
 Ventile Vorgesteuert
 Distributeurs à Commande Assistée
 Válvula Asistida
 Válvula Piloto Externo



Serie 01V

Pag. 18.17 - 18.29

Valvole Pneumatiche

Pneumatic Valve
 Pneumatische Ventile
 Distributeurs Pneumatiques
 Válvulas Neumáticas
 Válvulas Pneumáticas



Serie 01V

Pag. 18.30 - 18.36

Valvole ad Azionamento Manuale

Manual Valve
 Manuell Betätigte Ventile
 Distributeurs à Commandes Manuel
 Válvulas de Accionamiento Manual
 Válvulas de Acionamento Manual



Serie 01V - X1V

Pag. 18.37 - 18.47

Valvole ad azionamento meccanico

Mechanically actuated valve
 Mechanisch betätigte ventile
 Distributeurs à commandes mécaniques
 Válvulas de accionamiento mecánico
 Válvula de accionamento mecánico



Serie 01V

Pag. 18.48 - 18.51

Basi Multiple

Multiple Bases
 Mehrfach Grundplatten
 Embases Multiples
 Base Múltiple
 Bases Múltiplas

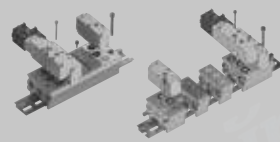

Serie 01V

Pag. 18.52 - 18.56

Micro Valvole

Micro Valves
 Mikroventile
 Microdistributeurs
 Microválvulas
 Micro-Válvulas



Serie 02V

Pag. 18.58 - 18.60

Valvole 16 mm

16 mm Valves
 Ventile 16 mm
 Distributeurs 16 mm
 Válvulas 16 mm
 Válvulas 16 mm



Serie 03V

Pag. 18.62 - 18.66

Valvole a Pannello, Pulsanti e Selettori

Panel Valve, Push Buttons and Selectors
 Schalttafelventile, Taster und Schalter
 Distributeurs pour commandes en panneau et boutons
 Válvulas de Panel, Pulsadores, Selectores
 Válvulas para Painel, Pulsantes e Seletoras



Serie 04V

Pag. 18.68 - 18.70

Valvole VDMA 18 mm

18 mm VDMA Valve
 Ventile 18 mm VDMA
 Distributeurs 18 mm VDMA
 Válvulas VDMA 18 mm
 Válvulas VDMA 18 mm



Serie 05V

Pag. 18.72 - 18.82

Valvole a Pedale

Pedal Valve
 Valvole a Pedale
 Distributeurs à Pédales
 Válvulas a Pedal
 Válvulas Pedal

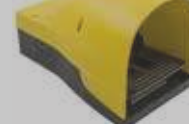

Serie 06V

Pag. 18.84 - 18.85

Elettropiloti

Solenoid Valve
 Magnetventile
 Electro Distributeurs
 Elettropilotos
 Válvulas Solenóide



Serie 07V

Pag. 18.87 - 18.89

Elettropiloti Miniaturizzati 10-15 mm

Miniature Solenoid Valve 10 - 15 mm
 Miniatur Ventile 10 - 15 mm
 Distributeurs Miniature au pluriel 10 - 15 mm
 Elettropiloto Miniaturizado 10 - 15 mm
 Elettropilotos Miniaturizados 10 - 15mm



Serie 07V

Pag. 18.90 - 18.96

Valvole NAMUR

NAMUR Valve
 NAMUR Ventile
 Distributeurs NAMUR
 Válvulas NAMUR
 Válvulas NAMUR



Serie 08V

Pag. 18.98 - 18.106

Valvole ISO 5599 - Taglia 1

Valves ISO 5599 - Size 1
 Ventile ISO 5599 - Größe 1
 Distributeurs a tiroir ISO 5599 - Taille 1
 Válvulas ISO 5599 - Tamaño 1
 Válvulas ISO 5599 - Tamanho 1



New

Serie 10V

Pag. 18.108 - 18.112

Valvole ISO 5599 - Taglia 2

Valves ISO 5599 - Size 2
 Ventile ISO 5599 - Größe 2
 Distributeurs a tiroir ISO 5599 - Taille 2
 Válvulas ISO 5599 - Tamaño 2
 Válvulas ISO 5599 - Tamanho 2



New

Serie 11V

Pag. 18.114 - 18.118

Valvola a Leva Manuale

Rotary Hand Lever Valve
 Handhebeventil
 Distributeur a Commande Manuelle
 Válvula de Leva Manual
 Válvula de Alavanca Manual



Serie 12V

Pag. 18.120 - 18.121

Valvola Elettropneumatica Modulare

Modula Solenoid Valve
 Modulare Druckluft-elektromagnet-ventile
 Ilots de Distribution Pneumatique
 Válvulas Electroneumáticas Modulares
 Válvulas Elettropneumáticas Modulares



Serie 15V

Pag. 18.123 - 18.162

Solenoidi e Connettori

Solenoid and Connectors
 Magnetspulen und Stecker
 Bobines et Connecteurs
 Bobinas y Conectores
 Solenóides e Conectores



Pag. 18.24 - 18.29 / 18.75

VALVOLE ELETTROPNEUMATICHE, PNEUMATICHE E MANUALI

MANUAL, PNEUMATIC AND SOLENOID PILOT VALVES

MANUELLE, PNEUMATISCHE & ELEKTROPNEUMATISCHE VENTILE

DISTRIBUTEURS ÉLECTROPNEUMATIQUES, PNEUMATIQUES & MÉCANIQUES

VÁLVULAS ELECTRONEUMÁTICAS, NEUMÁTICAS Y MANUALES

VÁLVULAS ELETRO-PNEUMÁTICAS, PNEUMÁTICAS E MANUAIS

Serie Valves

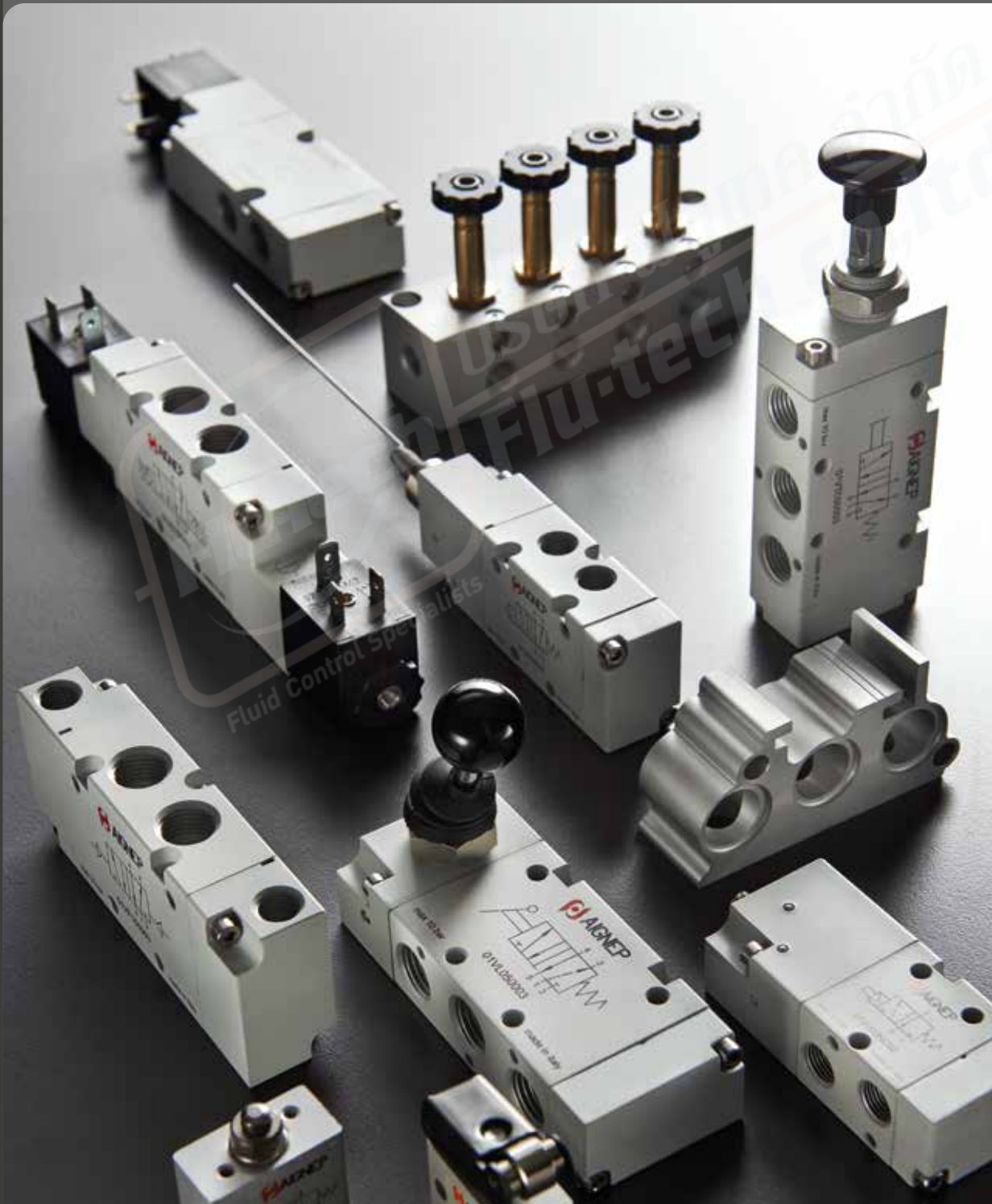

VALVES



บริษัท ฟลูเทค จำกัด
FLU-TECH CO.,LTD

845/3-4 หมู่ 3 ถ.เทพารักษ์ ต.เทพารักษ์ อ.เมือง จ.สมุทรปราการ 10270

845/3-4 Thepharak RD., T.Thepharak, A.Muang, Samutprakarn 10270 THAILAND
Tel. 0 2384 6060, Fax 0 2384 5701, Email : sales@flutech.co.th, www.flutech.co.th

VALVOLE 01V

Le Valvole Aignep Serie 01V, elettriche, pneumatiche e manuali, sono robuste, versatili e combinano prestazioni elevate con ingombro contenuto.

Queste valvole sono caratterizzate da alta portata, tempi di commutazione ridotti e bassa pressione di commutazione.

Disponibili in 3 taglie, 1/8 - 1/4 e 1/2 sono progettate per pressioni di esercizio fino a 10 bar.

Sono disponibili manifold di distribuzione per la creazione di batterie dedicate.

Valvole ATEX:

- Ex II 2 GD c T6 -10°C<Tamb<60°C

Le Bobine a basso assorbimento sono disponibili in tutte le tensioni, sono disponibili versioni:

- ATEX II2G EX DMD IIC T5 GB

- UL1446 CAN/CSA C22.2

Principali vantaggi

- Estremamente durevole
- Alto flusso in dimensioni compatte
- Facile Installazione
- Amplia gamma
- Basso consumo

Applicazioni

- Automazione Pneumatica, Robotica e manipolazione
- Automotive Process
- Industria tessile, imballaggio, farmaceutica, pesante
- Food Process
- ATEX Zone

01V VALVES

The 01V valve range is robust, versatile and combines high performances with compact installation dimensions.

Solenoid, electrical, mechanical and manual operated.

Large flow capacity, short change-over times and low change-over pressure.

Available in 3 sizes: 1/8 - 1/4 e 1/2 .

They can operate up to 10 bar working pressure. Multiple manifolds to create your own valves block. Solenoid coils are energy-saving and available in all voltage.

Valves ATEX:

- Ex II 2 GD c T6 -10°C<Tamb<60°C

Solenoid coils according to ATEX II2G EX DMD IIC T5 GB and UL1446 CAN/CSA C22.2 are also available.

Main advantages

- Extremely Durable
- High Flow in Compact Dimension
- Easy Installation
- Large Range
- Energy Saving

Applications

- Pneumatic Automation, Robotics, Handling
- Automotive Process
- Textile, Packaging, Heavy Duty
- Food Process
- ATEX Zone

VENTILE 01V

Die 01V Ventilbaureihe ist robust, vielseitig und kombiniert hohe Leistung mit kompakten Einbaumassen.

Magnetisch, elektrisch, mechanisch und manuell betrieben. Grosse Durchflussleistung, kurze Umrüstzeiten und niedriger Umschaltdruck.

Erhältlich in 3 Größen: 1/8 - 1/4 und 1/2". Sie können mit bis zu 10 bar Betriebsdruck arbeiten.

Verschiedene Verteilerblöcke um Ihre eigenen Ventileblöcke zu erstellen. Magnetspulen sind energiesparend und in allen Spannungen erhältlich.

Ventile ATEX:

- Ex II 2 GD c T6 -10°C<Tamb<60°C

Magnetspulen nach ATEX II2G EX DMD IIC T5 GBe UL1446 CAN / CSA C22.2 sind ebenfalls erhältlich.

Hauptvorteile

- Extrem Dauerhaft
- Hohe Durchflussleistung in kompakte Abmessungen
- Einfache Montage
- Weites Spektrum
- Energieeinsparung

Anwendungen

- Pneumatische Automation, Robotik, Handling
- Automobil Prozess
- Textil-, Verpackungs-, Schwerlast-Industrie
- Lebensmittel Prozess
- ATEX Bereich

DISTRIBUTEUR 01V

La gamme des distributeurs 01V est robuste, polyvalente et offre des performances élevées dans des dimensions compactes. Disponibles en commande électrique, mécanique et manuelle. Grande capacité de débit, faibles temps et basse pression de commutation.

Disponibles en 3 tailles: 1/8 1/4 et 1/2, sont conçus pour des pressions de service jusqu'à 10 bar.

Les bobines et connecteurs complètent l'offre. Les bobines sont économes en énergie et disponibles dans toutes les tensions.

Distributeur ATEX:

- **Ex** II 2 GD c T6 -10°C<Tamb<60°C

Bobines selon ATEX II2G EX DMD IIC T5 GB et UL 1446 CAN/CSA C22.2

Principaux avantages

- Longue durée de vie
- Haut débit avec dimension compact
- Facile d'installation
- Large gamme
- Faible consommation

Applications

- Automatismes pneumatiques, Robotique
- Process Automobile
- Industrie textile, l'emballage
- Process alimentaire
- Zone ATEX

VÁLVULAS 01V

Las válvulas Aignep Serie 01V, eléctricas, neumáticas y manuales, son robustas, versátiles y combinan elevadas prestaciones con dimensiones contenidas. Estas válvulas se caracterizan de gran caudal, tiempos de conmutación reducidos y baja presión de conmutación.

Disponibles en 3 tallas, 1/8 – 1/4 y 1/2 son proyectadas para presiones de ejercicio hasta 10 bar.

Están disponibles bases de distribución para la creación de baterías dedicadas.

Válvulas ATEX:

- **Ex** II 2 GD c T6 -10°C<Tamb<60°C

Las bobinas de bajo consumo están disponibles en todas las tensiones, también disponibles versiones ATEX II2G EX DMD IIC T5 GB y UL 1446 CAN/CSA C22.2

Principales ventajas

- Extremadamente Durable
- Alto Caudal en dimensiones compactas
- Fácil instalación
- Amplia Gama
- Bajo Consumo

Aplicaciones

- Automatización neumática, robótica y manipulación
- Procesos de automoción
- Industria textil, embalaje, farmacéutica, pesada
- Alimentaria
- Zona ATEX

VÁLVULAS 01V

As Válvulas Aignep Série 01V, elétricas, pneumáticas e manuais, são robustas, versáteis e combinam performance elevada com tamanho reduzido. Estas válvulas são caracterizadas por alta vazão, tempos de comutação reduzidos e baixa pressão de comutação.

Disponíveis em 3 tamanhos, 1/8" - 1/4" e 1/2" são projetadas para pressões de trabalho de até 10 bar.

São disponíveis manifolds para montagens de baterias de válvulas dedicadas.

Válvulas ATEX:

- **Ex** II 2 GD c T6 -10°C<Tamb<60°C

As bobinas estão disponíveis em todas as tensões, e nas versões ATEX II2G EX DMD IIC T5 GB e UL 1446 CAN/CSA C22.2

Principais Vantagens

- Extremamente durável
- Alto fluxo em com reduzidas dimensões
- Instalação fácil
- Ampla Gama
- Economia de Energia

Aplicações

- Automações Pneumática, Robótica e manipulação
- Processos Automotivos
- Indústria têxtil, embalagem, farmacêutica, industria pesada
- Processos Alimentícios
- Aprovação ATEX



บริษัท ฟลูเทค จำกัด
FLU-TECH CO.,LTD

845/3-4 หมู่ 3 ถ.เทพารักษ์ ต.เทพารักษ์ อ.เมือง จ.สมุทรปราการ 10270

845/3-4 Thepharak RD., T.Thepharak, A.Muang, Samutprakarn 10270 THAILAND
Tel. 0 2384 6060, Fax 0 2384 5701, Email : sales@flutech.co.th, www.flutech.co.th

VALVOLE 18 MM VDMA

VDMA 18 MM VALVE

VENTILE 18 MM VDMA

DISTRIBUTEURS 18 MM VDMA

VÁLVULAS 18 MM VDMA

VÁLVULA DE 18 MM VDMA



VALVOLE VDMA 18 MM AD AZIONAMENTO ELETTROPNEUMATICO

SOLENOID PILOT VALVE 18 MM VDMA
 ELEKTROPNEUMATISCHE VENTILE 18 MM VDMA
 DISTRIBUTEURS ÉLECTROPNEUMATIQUES 18 MM VDMA
 VÁLVULAS VDMA 18 MM DE ACCIONAMIENTO ELECTRONEUMÁTICO
 VÁLVULA VDMA DE 18 MM DE ACIONAMENTO ELETRO-PNEUMÁTICO



CARATTERISTICHE TECNICHE

TECHNICAL CHARACTERISTICS
 TECHNISCHE ANGABEN
 CARACTÉRISTIQUES TECHNIQUES
 CARACTERÍSTICAS TÉCNICAS
 CARACTERÍSTICAS TÉCNICAS



1907/2006
 REACH ✓

2011/65/CE
 RoHS ✓

PED
 2014/68/UE

ISO 15407-1
 VDMA 24563 SIZE 02 (18 mm)

	PORTATA a 6 BAR con Δp 1 bar 6 bar FLOW RATE with Δp 1 bar DURCHFLOSSWERT BEI 6 bar mit Δp 1 bar DÉBIT DE REFERENCE à 6 bar avec Δp 1 bar CAUDAL a 6 BAR con Δp 1 bar VAZÃO a 6 BAR com Δp 1 bar		550 NI/min
	PRESSIONE DI FUNZIONAMENTO OPERATING PRESSURE BETRIEBSDRUCK PRESSION DE SERVICE PRESIÓN DE EJERCICIO PRESSÃO DE OPERAÇÃO	Monostable	2.5 ÷ 10 bar
		Bistable	1 ÷ 10 bar
	TEMPERATURA TEMPERATURE BETRIEBSTEMPERATUR TEMPÉRATURE DE TRAVAIL TEMPERATURA TEMPERATURA	min	-10 °C
		max	+60 °C
	TENSIONE SOLENOIDE SOLENOID VOLTAGE SPANNUNG DER MAGNETSPULEN TENSION DE LA BOBINE TENSION SOLENOIDE TENSÃO DA SOLENOIDE		24V DC ÷ 24V AC
	POTENZA MINIMA MINIMUM POWER MIN. LEISTUNG PUISSANCE MIN. POTÊNCIA MÍNIMA POTÊNCIA MÍNIMA		2W - 3VA
	COMANDO MANUALE MANUAL CONTROL MANUELLE BETÄTIGUNG COMMANDE MANUELLE COMANDO MANUAL ACIONAMENTO MANUAL		MONOSTABILE MONOSTABLE MONOSTABIL MONOSTABLE MONOESTABLE MONOESTÁVEL
	TEMPI DI RISPOSTA RESPONSE TIME SCHALTZEITEN TEMPS DE RÉPONSE TIEMPO DE RESPUESTA TEMPOS DE RESPOSTA	Monostable	TRA = 13ms
			TRR = 26ms
			Bistable

TRA = Tempo di risposta bobina eccitata
 Response time with energised coil
 Schaltzeit einer bestromten Spule
 Temps de réponse de la bobine sous tension
 Tiempo de respuesta bobina excitada
 Tempo de resposta com bobina acionada

TRR = Tempo di risposta bobina diseccitata
 Response time with deenergised coil
 Schaltzeit einer stromlosen Spule
 Temps de réponse bobine hors tension
 Tiempo de respuesta bobina desexcitada
 Tempos de resposta com bobina desacionada

Materiali e Componenti IT

- Corpo in alluminio anodizzato
- Spola in alluminio nichelato
- Guarnizioni in NBR

Component Parts and Materials GB

- Anodised aluminium body
- Nickel-plated spool
- NBR seals

Komponenten und Materialien DE

- Aluminiumgehäuse Eloxiert
- Schieber aus Aluminium Vernickelt
- Dichtungen aus NBR

Matériaux et Composants FR

- Corps en aluminium anodisé
- Tiroir en aluminium nickelé
- Joints en NBR

Materiales y Componentes ES

- Cuerpo en Aluminio Anodizado
- Corredera en Aluminio Niquelado
- Juntas en NBR

Materiais e Componentes PT

- Corpo em Alumínio Anodizado
- Carreta Alumínio Niquelado
- Vedação em NBR



Tabella dei codici di ordinazione

- Ordering codes
- Bestellschlüssel
- Code de commande
- Tabla de codificación para pedidos
- Tabela de codificação para compra

SERIE	Azionamento Actuation Betätigung Actionnement Accionamiento Acionamento	Riazionamento Reactuation Rückstellung Rappel Reaccionamiento Retorno	Vie Ways Wege Voies Vias Vias	Funzione Function Funktion Fonction Función Funções	Misura Size Größe Dimension Medida Tamanho
-------	--	--	--	--	---

0 5 V

S

0

7

CC

0 0

S = Solenoide
Solenoid
Magnetspule
Bobine
Solenóide
Solenoíde

0 = Monostabile con ritorno a molla
Monostable spring return
Monostabil mit Federrückstellung
Monostable à rappel par ressort
Monoestable con retorno muelle
Monoestável com retorno por mola

1 = Bistabile
Bistable
Bistabil
Bistable
Biestable
Biestável

5 = 5/2
7 = 5/3

CC = Centri chiusi
Center closed
Mittelstellung geschlossen
Centre fermé
Centros cerrados
Centro fechado

OC = Centri aperti
Center exhausted
Mittelstellung offen
Centre ouvert
Centros abiertos
Centro-aberto negativo

00 = Funzione non contemplata
Function not provided
Funktion steht nicht zur Verfügung
Fonction non disponible
Función no contemplada
Função não contemplada

00 = 24V DC
01 = 24V AC

5/2 Vie - Ways - Wege - Voies - Vias - Vias

MONOSTABILE CON RITORNO A MOLLA

- MONOSTABLE SPRING RETURN
- MONOSTABIL MIT FEDERRÜCKSTELLUNG
- MONOSTABLE À RAPPEL PAR RESSORT
- MONOESTABLE CON RETORNO POR MUELLE
- MONOESTÁVEL COM RETORNO POR MOLA

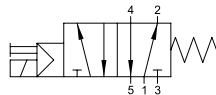

Codice Code Nummer Code Código Código	Vie Ways Wege Voies Vias Vias	Solenoide Solenoid Magnetspule Bobine Solenóide Solenoíde	Pack.
05V S0 5 00 00	5/2	24V DC	1
05V S0 5 00 01	5/2	24V 50/60Hz	1

5/2 Vie - Ways - Wege - Voies - Vias - Vias

BISTABILE

- TWO STABLE POSITIONS
- BISTABIL
- BISTABLE
- BIESTABLE
- BIESTÁVEL

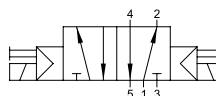

Codice Code Nummer Code Código Código	Vie Ways Wege Voies Vias Vias	Solenoide Solenoid Magnetspule Bobine Solenóide Solenoíde	Pack.
05V S1 5 00 00	5/2	24V DC	1
05V S1 5 00 01	5/2	24V 50/60Hz	1

5/3 Vie - Ways - Wege - Voies - Vías - Vias

MONOSTABILE CON RITORNO A MOLLA
 MONOSTABLE SPRING RETURN
 MONOSTABIL MIT FEDERRÜCKSTELLUNG
 MONOSTABLE À RAPPEL PAR RESSORT
 MONOESTABLE CON RETORNO POR MUELLE
 MONOESTÁVEL COM RETORNO POR MOLA

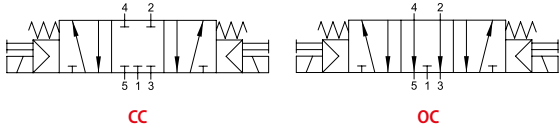

Codice Code Nummer Code Código Código	Vie Ways Wege Voies Vías Vias	Funzione Function Funktion Fonction Función Funções	Solenoide Solenoid Magnetspule Bobine Solenóide Solenóide	Pack.
05V S0 7 CC 00	5/3	CC	24V DC	1
05V S0 7 OC 00	5/3	OC	24V DC	1
05V S0 7 CC 01	5/3	CC	24V 50/60Hz	1
05V S0 7 OC 01	5/3	OC	24V 50/60Hz	1

05V S0 5 00 00 05V S0 5 00 01

05V S0 7 CC 00 05V S0 7 OC 00 05V S0 7 CC 01 05V S0 7 OC 01

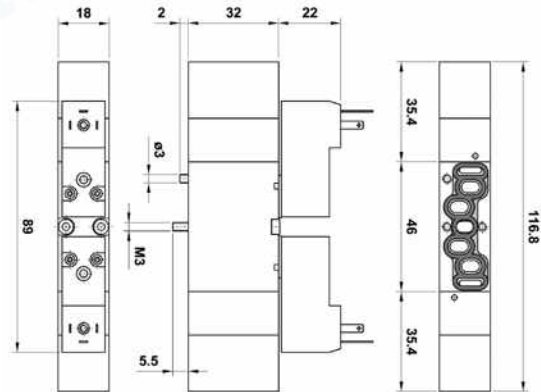
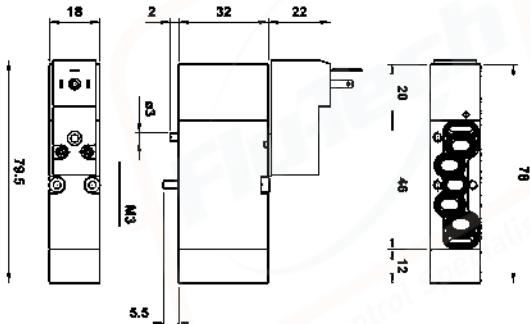

05V S1 5 00 00 05V S1 5 00 01

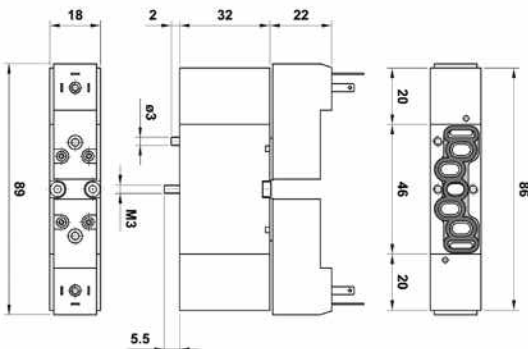

Connettori 15 mm

Connectors
Stecker
Connecteurs
Conectores
Conectores



Codice Code Nummer Code Código Código	Colore Color Farbe Couleur Color Cor	Caratteristiche Characteristics Eigenschaften Caractéristiques Características Características	Pack.
CON 11 000 01	■	2 POLI - Pins - Pins - Broches - Pins - Pinos	1
CON 12 024 00	□	LED + VDR 0 - 24V	1

■ NERO BLACK SCHWARZ NOIR NEGRO PRETO	□ TRASPARENTE TRANSPARENT TRANSPARENT TRANSPARENT TRANSPARENT TRANSPARENT
--	--

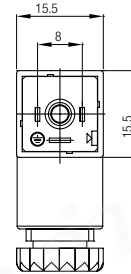

VDR: Dotati di Varistore come dispositivo di protezione delle sovratensioni.
Fitted with varistors as surge protection device.
Ausgestattet mit Varistor als ÜberSpannungsschutz.
Equipé avec varistance de protection contre les surtensions.
Dotado de Varistor como dispositivo de protección de sobretensiones.
Dotados de Varistor como dispositivo de proteção de sobretenção.

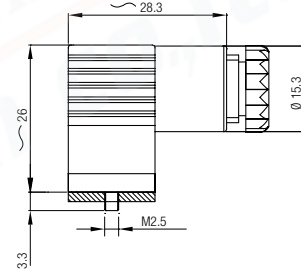

Schema elettrico

- Wiring
- Elektroschema
- Schéma électrique
- Esquema eléctrico
- Esquema elétrico

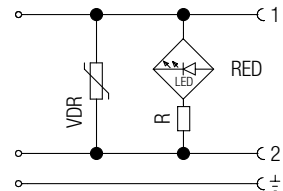
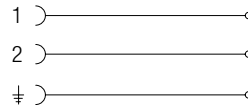

CON11 000 01

CON12 024 00

GRADO DI PROTEZIONE
DEGREE OF PROTECTION
SCHUTZART
DEGRÉ DE PROTECTION
GRADO DE PROTECCIÓN
GRAU DE PROTEÇÃO

IP67 IEC 60529

DIAMETRO CAVO
CABLE DIAMETER
KABELDURCHMESSER
DIAMÈTRE DU CÂBLE
DIÁMETRO DEL CABLE
DIÂMETRO DO CABO

4 ÷ 6 mm

TERMINALI
TERMINALS
VERBINDUNG
CONNEXION
TERMINALES
TERMINAIS

DIN 4365 C

VALVOLE VDMA 18 MM AD AZIONAMENTO PNEUMATICO

PNEUMATIC VALVE 18 MM VDMA
 PNEUMATISCHE VENTILE 18 MM VDMA
 DISTRIBUTEURS PNEUMATIQUES 18 MM VDMA
 VÁLVULAS VDMA 18 MM DE ACCIONAMIENTO NEUMÁTICO
 VÁLVULA VDMA DE 18 MM DE ACIONAMENTO PNEUMÁTICO



CARATTERISTICHE TECNICHE

TECHNICAL CHARACTERISTICS
 TECHNISCHE ANGABEN
 CARACTÉRISTIQUES TECHNIQUES
 CARACTERÍSTICAS TÉCNICAS
 CARACTERÍSTICAS TÉCNICAS



Norma di Riferimento

Reference standard

Entspricht der Norm

Norme de référence

Normativa de referencia

Norma de referência

1907/2006

REACH ✓

2011/65/CE

RoHS ✓

PED

2014/68/UE

ISO 15407-1

VDMA 24563 SIZE 02 (18 mm)

	PORTATA a 6 BAR con Δp 1 bar 6 bar FLOW RATE with Δp 1 bar DURCHFLOSSWERT BEI 6 bar mit Δp 1 bar DÉBIT DE RÉFÉRENCE à 6 bar avec Δp 1 bar CAUDAL a 6 BAR con Δp 1 bar VAZÃO a 6 BAR com Δp 1 bar		550 Nl/min
	PRESSIONE DI AZIONAMENTO PRESSURE DRIVE STEUERDRUCK PRESSION DE COMMANDE PRESIÓN DE ACCIONAMIENTO PRESSÃO DE ACIONAMENTO		0 ÷ 10 bar
	PRESSIONE DI FUNZIONAMENTO OPERATING PRESSURE BETRIEBSDRUCK PRESSION DE SERVICE PRESIÓN DE EJERCICIO PRESSÃO DE OPERAÇÃO	Monostable	2 ÷ 10 bar
		Bistable	1 ÷ 10 bar
	TEMPERATURA TEMPERATURE BETRIEBSTEMPERATUR TEMPÉRATURE DE TRAVAIL TEMPERATURA	min	-10 °C
		max	+60 °C
	TEMPI DI RISPOSTA RESPONSE TIM SCHALTZEITEN TEMPS DE RÉPONSE TIEMPO DE RESPUESTA TEMPOS DE RESPOSTA	Monostable	TRA = 12 ms
			TRR = 24 ms
		Bistable	TRA=TRR = 21 ms

TRA = Tempo di risposta bobina eccitata
 Response time with energised coil
 Schaltzeit einer bestromten Spule
 Temps de réponse de la bobine sous tension
 Tiempo de respuesta bobina excitada
 Tempo de resposta com bobina acionada

TRR = Tempo di risposta bobina diseccitata
 Response time with deenergised coil
 Schaltzeit einer stromlosen Spule
 Temps de réponse bobine hors tension
 Tiempo de respuesta bobina desexcitada
 Tempos de resposta com bobina desacionada

Materiali e Componenti

IT

- 1 Corpo in alluminio anodizzato
- 2 Spola in alluminio nichelato
- 3 Guarnizioni in NBR

Component Parts and Materials

GB

- 1 Anodised aluminium body
- 2 Nickel-plated spool
- 3 NBR seals

Komponenten und Materialien

DE

- 1 Aluminiumgehäuse Eloxiert
- 2 Schieber aus Aluminium Vernickelt
- 3 Dichtungen aus NBR

Matériaux et Composants

FR

- 1 Corps en aluminium anodisé
- 2 Tiroir en aluminium nickelé
- 3 Joints en NBR

Materiales y Componentes

ES

- 1 Cuerpo en Aluminio Anodizado
- 2 Carreter Aluminio Niquelado
- 3 Juntas en NBR

Materiais e Componentes

PT

- 1 Corpo em Alumínio Anodizado
- 2 Carreter Aluminio Niquelado
- 3 Vedação em NBR



Tabella dei codici di ordinazione

- Ordering codes
- Bestellschlüssel
- Code de commande
- Tabla de codificación para pedidos
- Tabela de codificação para compra

SERIE	Azionamento Actuation Betätigung Actionnement Accionamiento Acionamento	Riazionamento Reactuation Rückstellung Rappel Reaccionamiento Retorno	Vie Wege Wege Voies Vias Vias	Funzione Funktion Funktion Fonction Función Funções	Misura Size Größe Dimensión Medida Tamanho
--------------	---	---	---	---	--

0 5 V

P

0

5

0 0

0 0

P = Pneumatico
Pneumatic
Pneumatisch
Pneumatiques
Neumático
Pneumatic

0 = Monostabile con ritorno a molla
Monostable spring return
Monostabil mit Federrückstellung
Monostable à rappel par ressort
Monoestable con retorno por muelle
Monoestável com retorno por mola

1 = Bistabile
Bistable
Bistabil
Bistable
Biestable
Biestável

5 = 5/2
7 = 5/3

CC = Centri chiusi
Center closed
Mittelstellung geschlossen
Centre fermé
Centros cerrados
Centro fechado

OC = Centri aperti
Center exhausted
Mittelstellung offen
Centre ouvert
Centros abiertos
Centro-aberto negativo

00 = Funzione non contemplata
Function not provided
Funktion steht nicht zur Verfügung
Fonction non disponible
Función no contemplada
Função não contemplada

5/2 Vie - Ways - Wege - Voies - Vias - Vias

MONOSTABILE CON RITORNO A MOLLA

MONOSTABLE SPRING RETURN
MONOSTABIL MIT FEDERRÜCKSTELLUNG
MONOSTABLE À RAPPEL PAR RESSORT
MONOESTABLE CON RETORNO POR MUELLE
MONOESTÁVEL COM RETORNO POR MOLA

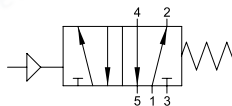

Codice Code Nummer Code Código Código	Vie Ways Wege Voies Vias Vias	Pack.
05V P0 5 00 00	5/2	1

5/2 Vie - Ways - Wege - Voies - Vias - Vias

BISTABILE

TWO STABLE POSITIONS
BISTABIL
BISTABLE
BIESTABLE
BIESTÁVEL

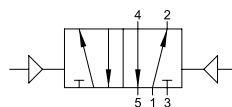

Codice Code Nummer Code Código Código	Vie Ways Wege Voies Vias Vias	Pack.
05V P1 5 00 00	5/2	1

5/3 Vie - Ways - Wege - Voies - Vías - Vias

MONOSTABILE CON RITORNO A MOLLA

MONOSTABLE SPRING RETURN
 MONOSTABIL MIT FEDERRÜCKSTELLUNG
 MONOSTABLE À RAPPEL PAR RESSORT
 MONOESTABLE CON RETORNO POR MUELLE
 MONOESTÁVEL COM RETORNO POR MOLA

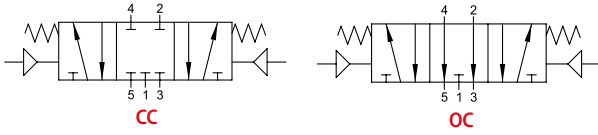

Codice Code Nummer Code Código	Vie Ways Wege Voies Vías Vias	Funzione Function Funktion Fonction Función Funções	Pack.
05V P0 7 CC 00	5/3	CC	1
05V P0 7 OC 00	5/3	OC	1

05V P0 5 00 00

05V P0 7 CC 00 05V P0 7 OC 00

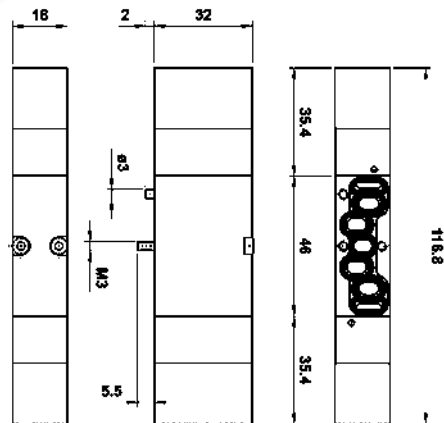
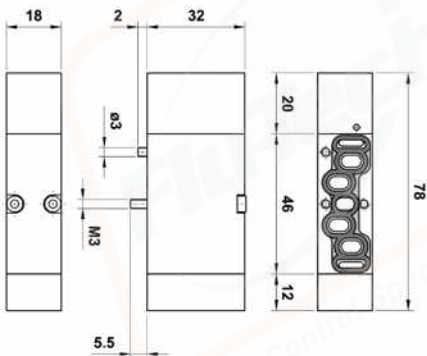

05V P1 5 00 00

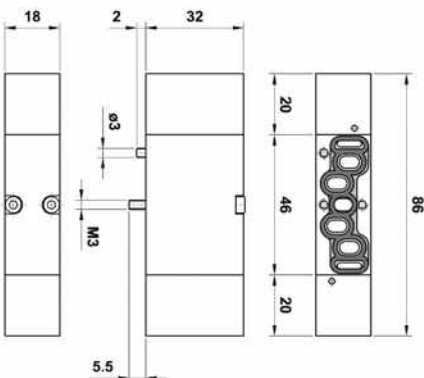

BASI MULTIPLE E ACCESSORI

MULTIPLE BASES AND ACCESSORIES
 MEHRFACH GRUNDPLATTEN UND ZUBEHÖR
 EMBASES MULTIPLES ET ACCESSOIRES
 BASES MÚLTIPLES Y ACCESORIOS
 BASES MÚLTIPLAS E ACESSÓRIOS

Tutte le basi e accessori sono complete di viti e guarnizioni per un corretto montaggio.
 All the bases are supplied with screws and seals to secure the correct assembly.
 Alle Grundplatten und Zubehör werden komplett mit Schrauben und Dichtungen für eine ordnungsgemässe Montage geliefert.
 Toutes les embases et les accessoires sont équipés avec des vis et des joints d'étanchéité pour une installation correcte.
 Todos los módulos y accesorios están completos de tornillos y juntas para un correcto montaje.
 Todas as bases e acessórios incluem parafusos e vedações para uma montagem correta.

TERMINALE ANTERIORE CON BASE INTEGRATA

FRONT TERMINAL-BASED INTEGRATED
 FRONT-GRUNDPLATTEN
 EMBASE D'EXTRÉMITÉ (ALIMENTATION)
 TERMINAL ANTERIOR CON BASE INTEGRADA
 TERMINAL FRONTAL COM BASE INTEGRADA



Code	Pack.
05V B1 0 00 00	1

TERMINALE POSTERIORE CON BASE INTEGRATA

REAR TERMINAL-BASED INTEGRATED
 END-GRUNDPLATTEN
 EMBASE D'EXTRÉMITÉ
 TERMINAL POSTERIOR CON BASE INTEGRADA
 TERMINAL TRASEIRO COM BASE INTEGRADA



Code	Pack.
05V B2 0 00 00	1

BASE MODULARE

MODULAR BASE
 ZWISCHEN-GRUNDPLATTEN
 EMBASES INTERMÉDIAIRES
 BASE MODULAR
 BASE MODULAR



Code	Pack.
05V B3 0 00 00	1

ALIMENTAZIONE INTERMEDIA

INTERMEDIATE POWER
 ZWISCHEN-GRUNDPLATTEN FÜR DRUCKEINSPEISUNG
 EMBASES INTERMÉDIAIRES D'ALIMENTATION
 ALIMENTACIÓN INTERMEDIA
 ALIMENTAÇÃO INTERMEDIÁRIA



Code	Pack.
05V B4 0 00 00	1

05V B1 0 00 00

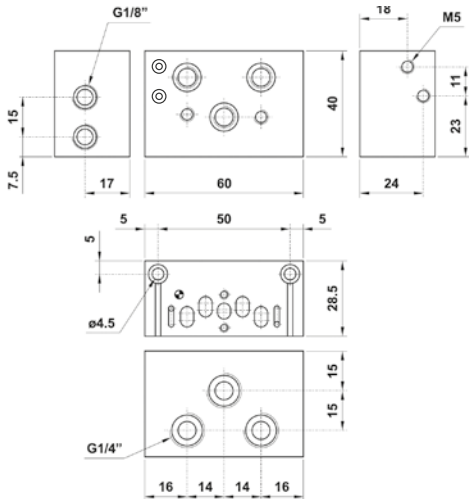

05V B2 0 00 00

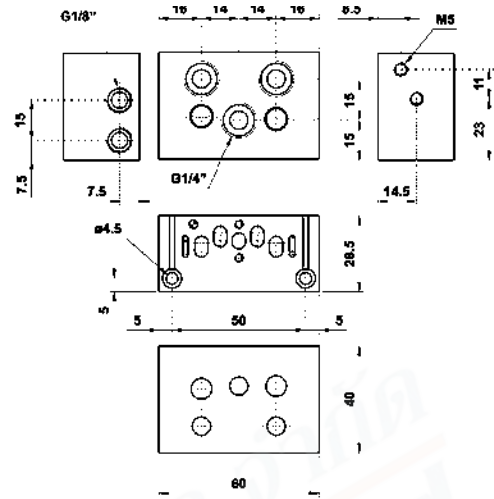

05V B3 0 00 00

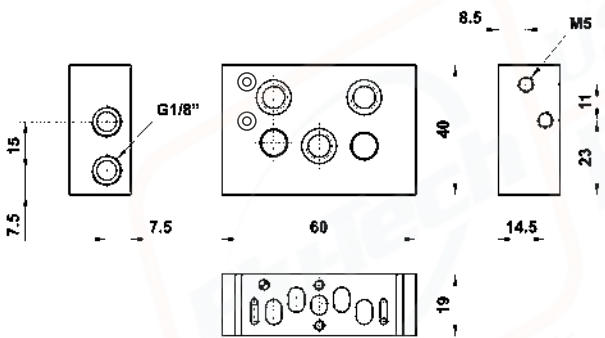

05V B4 0 00 00

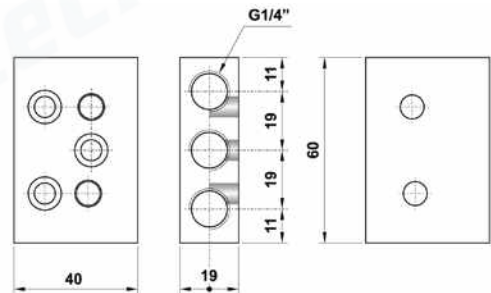

TAPPO INTERMEDIO

INTERMEDIATE PLUG
 VERSCHLUSSPLATTE
 EMBASE DE FERMETURE
 TAPÓN INTERMEDIO
 TAMPÃO INTERMEDIÁRIO



Code	Pack.
05V B8 0 00 00	1

GUARNIZIONE PER TAPPO INTERMEDIO

GASKET FOR INTERMEDIATE PLUG
 DICHTUNG FÜR VERSCHLUSSPLATTE
 JOINT POUR L'EMBASE DE FERMETURE
 JUNTA PARA TAPÓN INTERMEDIO
 VEDAÇÃO PARA TAMPÃO INTERMEDIÁRIO



Code	Pack.
05V B7 0 00 00	1

La guarnizione è fornita con grano da M8.
 The gasket is supplied with M8 dowel.
 Die Dichtung für Verschlussplatte wird mit Gewindestift M8 geliefert.
 Le joint pour l'embase de fermeture est fourni avec vis sans tête M8.
 La junta es suministrada con espiga de M8.
 A vedação é fornecida com um bujão de M8.

PIASTRINA DI COPERTURA

COVER PLATE
 ABDECKPLATTE
 PLAQUE DE COUVERTURE
 PLACA DE CIERRE
 PLACA CEGA



Code	Pack.
05V B9 0 00 00	1

BASE SINGOLA

INDIVIDUAL BASE
 EINZEL-GRUNDPLATTEN
 EMBASE UNITAIRE
 BASE SIMPLE
 BASE INDIVIDUAL



Code	Pack.
05V B5 0 00 00	1

05V B5 0 00 00

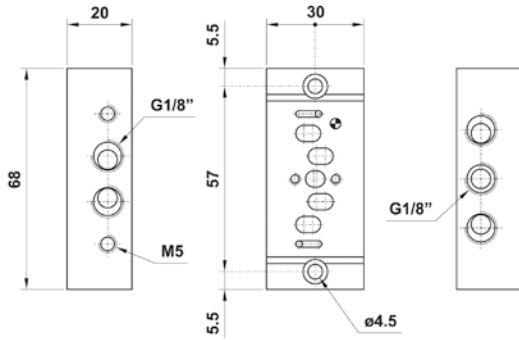

05V B7 0 00 00

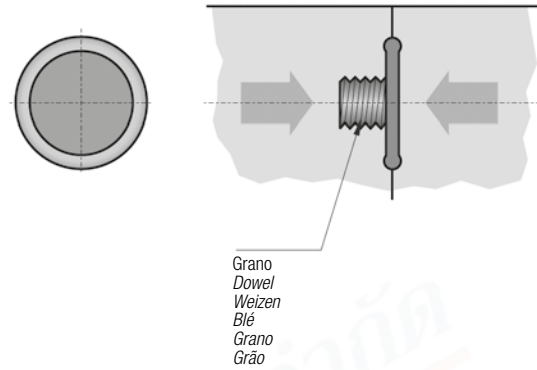

05V B8 0 00 00

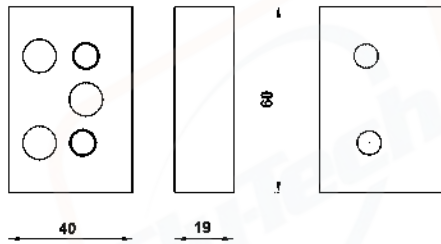

05V B9 0 00 00

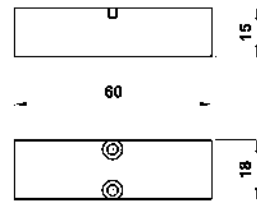

Esempio di montaggio

Example of assembling

Montagebeispiel

Exemple de montage

Ejemplo de montaje

Exemplo de montagem

