



PRODUCT INFORMATION

LUBRICATORS

AIR PREPARATION



ROSS CONTROLS

LUBRICATORS – KEY FEATURES

- Sight-feed and wick-feed design options
- Sight-feed Lubricators are easy to adjust, and an indicator on the sight dome measures the amount of oil dispensed
- The adjusting knob can be removed to make the lubricator “tamper-resistant”
- All working parts are in an easily replaceable cartridge
- Modular and in-line mounting options
- Metal and High Strength polycarbonate bowl options
- External tamper resistant adjustment
- Quick-fill cap option for full size, MD3™, and MD4™ Series
- Extended bowls available for MD3™ and MD4™ Series

LUBRICATOR TYPE/SERIES	AVAILABLE PORT SIZES								FLOW MAX FLOW (scfm)	DESIGN		BOWL TYPE		Page
	1/8	1/4	3/8	1/2	3/4	1	1¼	1½		SIGHT FEED	WICK FEED	POLYCARBONATE	METAL	
BANTAM									27					G4.3
MINIATURE									25					G4.4
MID-SIZE									110					G4.5
MD3™									150					G4.6
FULL-SIZE									140					G4.7
MD4™									205					G4.8
HIGH-CAPACITY									500					G4.9



Port Sizes: 1/8 & 1/4, and Tube Fittings – Flow to 27 scfm

Port Size	Threaded Ports		Tube Fittings	
	Polycarbonate Bowl	Metal Bowl	Polycarbonate Bowl	Metal Bowl
	Model Number	Model Number	Model Number	Model Number
FILL PORT				
1/8 NPTF	5B01B0005	5B01B0006	–	–
1/8 G	C5B01B0005	C5B01B0006	–	–
1/4 NPTF	5B02B0005	5B02B0006	–	–
1/4 G	C5B02B0005	C5B02B0006	–	–
1/4	–	–	5B03B0005	5B03B0006
3/8	–	–	5B04B0005	5B04B0006
4mm	–	–	5B05B0005	5B05B0006
6mm	–	–	5B06B0005	5B06B0006
8mm	–	–	5B07B0005	5B07B0006
10mm	–	–	5B08B0005	5B08B0006
QUICK-FILL CAP				
1/8 NPTF	5B01B0007	5B01B0008	–	–
1/8 G	C5B01B0007	C5B01B0008	–	–
1/4 NPTF	5B02B0007	5B02B0008	–	–
1/4 G	C5B02B0007	C5B02B0008	–	–
1/4	–	–	5B03B0007	5B03B0008
3/8	–	–	5B04B0007	5B04B0008
4mm	–	–	5B05B0007	5B05B0008
6mm	–	–	5B06B0007	5B06B0008
8mm	–	–	5B07B0007	5B07B0008
10mm	–	–	5B08B0007	5B08B0008

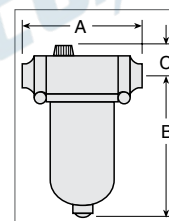
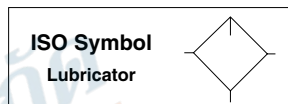

Port Size	Bowl Capacity	Dimensions inches (mm)				Weight lb (kg)
		A	B**	C	Depth	
No Port	2-oz (60-ml)	1.7 (43)	3.6 (91)	0.9 (22)	1.8 (45)	0.17 (0.08)
1/8, 1/4 (NPTF or G)	2-oz (60-ml)	3.0 (76)	3.6 (91)	0.9 (22)	1.8 (45)	0.37 (0.17)
Models below have quick-connect tube fittings.						
1/4	2-oz (60-ml)	3.4 (86)	3.6 (91)	0.9 (22)	1.8 (45)	0.37 (0.17)
3/8	2-oz (60-ml)	3.9 (99)	3.6 (91)	0.9 (22)	1.8 (45)	0.37 (0.17)
4 mm	2-oz (60-ml)	3.4 (86)	3.6 (91)	0.9 (22)	1.8 (45)	0.37 (0.17)
6 mm	2-oz (60-ml)	3.4 (86)	3.6 (91)	0.9 (22)	1.8 (45)	0.37 (0.17)
8 mm	2-oz (60-ml)	3.4 (86)	3.6 (91)	0.9 (22)	1.8 (45)	0.37 (0.17)
10 mm	2-oz (60-ml)	3.9 (99)	3.6 (91)	0.9 (22)	1.8 (45)	0.37 (0.17)

** Dimension for polycarbonate bowl; metal bowl is 3.8 (97).

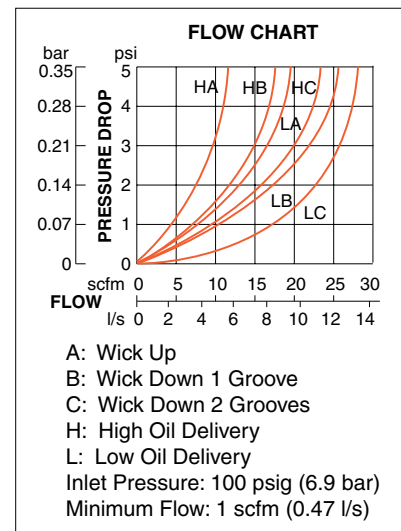

Accessories ordered separately, refer to page G6.3-4.

STANDARD SPECIFICATIONS (for lubricators on this page):

Construction Design	Wick-Feed	Oil Adjustment	External, no shutoff
Temperature	Ambient/Media: Polycarbonate Bowl: 40° to 125°F (4° to 52°C) Metal Bowl: 40° to 150°F (4° to 66°C)	Construction Material	Body: Acetal Bowl: Polycarbonate or Aluminum Seals: Nitrile
Fluid Media	Compressed air		
Operating Pressure	Polycarbonate Bowl: Maximum 150 psig (10 bar) Metal Bowl: Maximum 200 psig (14 bar)		



บริษัท ฟลูเทค จำกัด
FLU-TECH CO.,LTD

845/3-4 หมู่ 3 ถ.เทพารักษ์ ต.เทพารักษ์ อ.เมือง จ.สมุทรปราการ 10270
845/3-4 Thepharak RD., T.Thepharak, A.Muang, Samutprakarn 10270 THAILAND
Tel. 0 2384 6060, Fax 0 2384 5701, Email : sales@flutech.co.th, www.flutech.co.th

Port Sizes: 1/8 & 1/4 – Flow to 25 scfm

Port Size	Port Threads	Polycarbonate Bowl		Metal Bowl	
		High-Flow	Low Flow	High-Flow	Low Flow
		Model Number	Model Number	Model Number	Model Number
With Fill Port					
1/8	NPTF	5111B1010	5111B1012	5112B1010	5112B1012
	G	C5111B1010	C5111B1012	C5112B1010	C5112B1012
1/4	NPTF	5111B2010	5111B2012	5112B2010	5112B2012
	G	C5111B2010	C5111B2012	C5112B2010	C5112B2012
With Quick-Fill Cap					
1/8	NPTF	5111B1110	5111B1112	5112B1110	5112B1112
	G	C5111B1110	C5111B1112	C5112B1110	C5112B1112
1/4	NPTF	5111B2110	5111B2112	5112B2110	5112B2112
	G	C5111B2110	C5111B2112	C5112B2110	C5112B2112

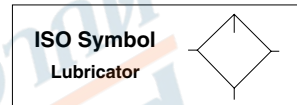

Port Size	Bowl Type	Bowl Capacity	Dimensions inches (mm)				Weight lb (kg)
			A	B	C	Depth	
1/8, 1/4	Polycarbonate	2-oz (60-ml)	1.6 (41)	3.6 (92)	0.7 (17)	1.6 (41)	0.21 (0.10)
	Aluminum	2-oz (60-ml)	1.6 (41)	3.8 (97)	0.7 (17)	1.6 (41)	0.21 (0.10)

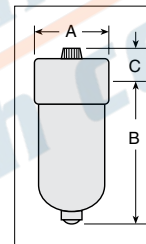

G4

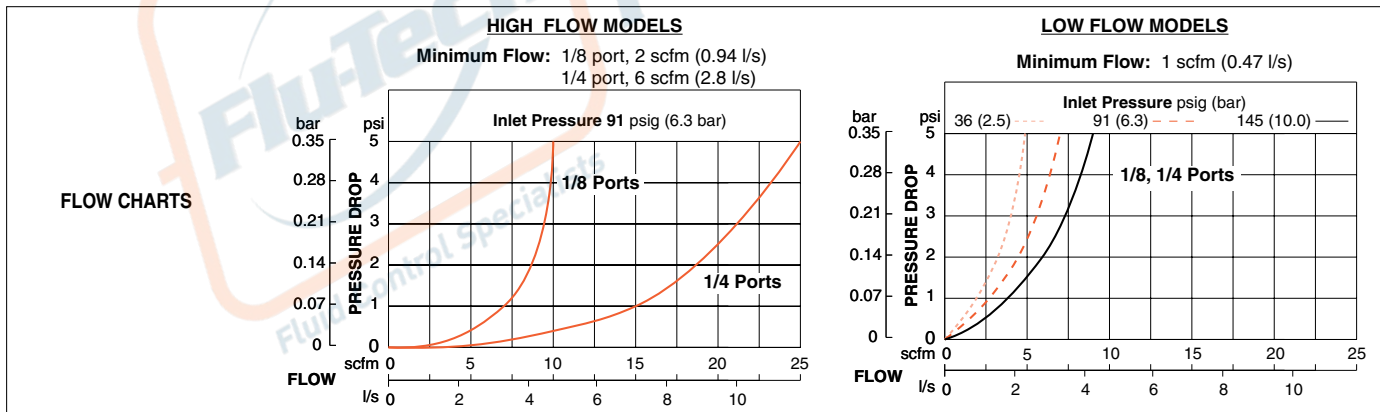

G

Accessories ordered separately, refer to page G6.3-4.

STANDARD SPECIFICATIONS (for lubricators on this page):

Construction Design	Wick-Feed	Oil Adjustment	Internal, tamper-proof
Temperature	Ambient/Media: Polycarbonate Bowl: 40° to 125°F (4° to 52°C) Metal Bowl: 40° to 150°F (4° to 66°C)	Construction Material	Body: Aluminum Bowl: Polycarbonate or Aluminum Seals: Nitrile
Fluid Media	Compressed air		
Operating Pressure	Polycarbonate Bowl: Maximum 150 psig (10 bar) Metal Bowl: Maximum 200 psig (14 bar)		



บริษัท ฟลูเทค จำกัด
FLU-TECH CO.,LTD

845/3-4 หมู่ 3 ถ.เทพารักษ์ ต.เทพารักษ์ อ.เมือง จ.สมุทรปราการ 10270
845/3-4 Thepharak RD., T.Thepharak, A.Muang, Samutprakarn 10270 THAILAND
Tel. 0 2384 6060, Fax 0 2384 5701, Email : sales@flutech.co.th, www.flutech.co.th

Port Sizes: 1/4, 3/8 & 1/2 – Flow to 110 scfm

Port Size	Polycarbonate Bowl		Metal Bowl	
	Sight-Feed		Sight-Feed	
	Model Number		Model Number	
	NPTF Threads	G Threads	NPTF Threads	G Threads
With Fill Port				
1/4	5111B2007	C5111B2007	5112B2007	C5112B2007
3/8	5111B3007	C5111B3007	5112B3007	C5112B3007
1/2	5111B4007	C5111B4007	5112B4007	C5112B4007
With Quick-Fill Cap				
1/4	5111B2107	C5111B2107	5112B2107	C5112B2107
3/8	5111B3107	C5111B3107	5112B3107	C5112B3107
1/2	5111B4107	C5111B4107	5112B4107	C5112B4107

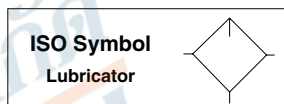

Port Size	Bowl Type	Bowl Capacity	Dimensions inches (mm)				Weight lb (kg)
			A	B	C	Depth	
1/4, 3/8, 1/2	Polycarbonate	4-oz (120-ml)	2.7 (68)	4.1 (103)	1.8 (46)	2.4 (60)	1.06 (0.48)
	Zinc	4-oz (120-ml)	2.7 (68)	4.1 (103)	1.8 (46)	2.4 (60)	1.50 (0.68)

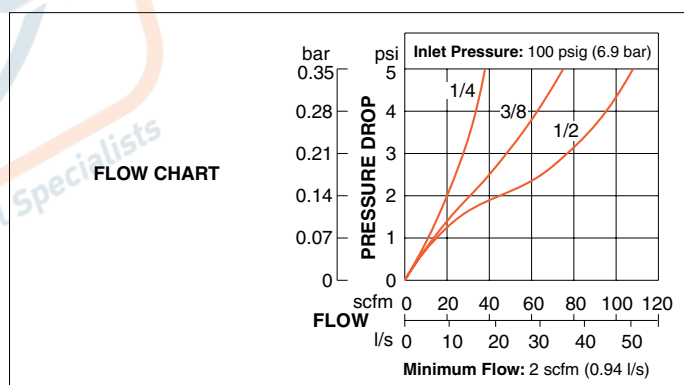
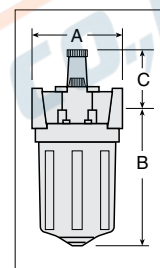

Accessories ordered separately, refer to page G6.3-4.

STANDARD SPECIFICATIONS (for lubricators on this page):

Construction Design	Sight-Feed	Oil Adjustment	External, tamper-resistant
Temperature	Ambient/Media: Polycarbonate Bowl: 40° to 125°F (4° to 52°C) Metal Bowl: 40° to 175°F (4° to 80°C)	Construction Material	Body: Zinc Bowl: Polycarbonate bowl with zinc shatterguard, or zinc bowl Sight Dome: Nylon Seals: Nitrile
Fluid Media	Compressed air		
Operating Pressure	Polycarbonate Bowl: Maximum 150 psig (10 bar) Metal Bowl: Maximum 200 psig (14 bar)		



บริษัท ฟลูเทค จำกัด
FLU-TECH CO.,LTD

845/3-4 หมู่ 3 ถ.เทพารักษ์ ต.เทพารักษ์ อ.เมือง จ.สมุทรปราการ 10270
845/3-4 Thepharak RD., T.Thepharak, A.Muang, Samutprakarn 10270 THAILAND
Tel. 0 2384 6060, Fax 0 2384 5701, Email : sales@flutech.co.th, www.flutech.co.th

Port Sizes: 1/4, 3/8 & 1/2 – Flow to 150 scfm

HOW TO ORDER

Choose your options (in red) to configure your model number.

MD3 **51P** **Q** **C** **2** **2**

BOWL MATERIAL/SIZE	
Polycarbonate Bowl 5.1-oz (151-ml)	51P
Metal Bowl 6-oz (177-ml)	51M
Extended Metal Bowl 10-oz (295-ml)	51E

LUBRICATOR FILL TYPE	
Quick Fill Cap	Q
Fill Port	S

PIPE SIZE	
1/4 NPTF	2
3/8 NPTF	3
1/2 NPTF	4
1/4 G	B
3/8 G	C
1/2 G	D

CAP COLOR	
Black	2
Yellow	Y

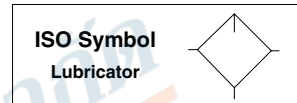

Bowl Type	Dimensions inches (mm)				Weight lb (kg)
	A	B**	C	Depth	
Polycarbonate	3.0 (76.2)	4.72 (119.9)	2.21 (56.1)	2.51 (63.8)	1.30 (0.59)
Aluminum	3.0 (76.2)	6.02 (152.9)	2.21 (56.1)	2.76 (70.1)	1.42 (0.64)
Extended Aluminum	3.0 (76.2)	9.37 (238)	2.21 (56.1)	2.76 (70.1)	1.54 (0.70)

** Bowl removal clearance: add 3.1 (79).
Extended Bowl removal clearance: add 6.1 (155).

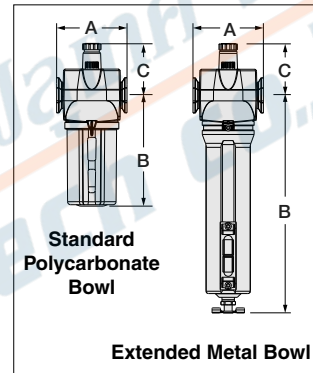

G4

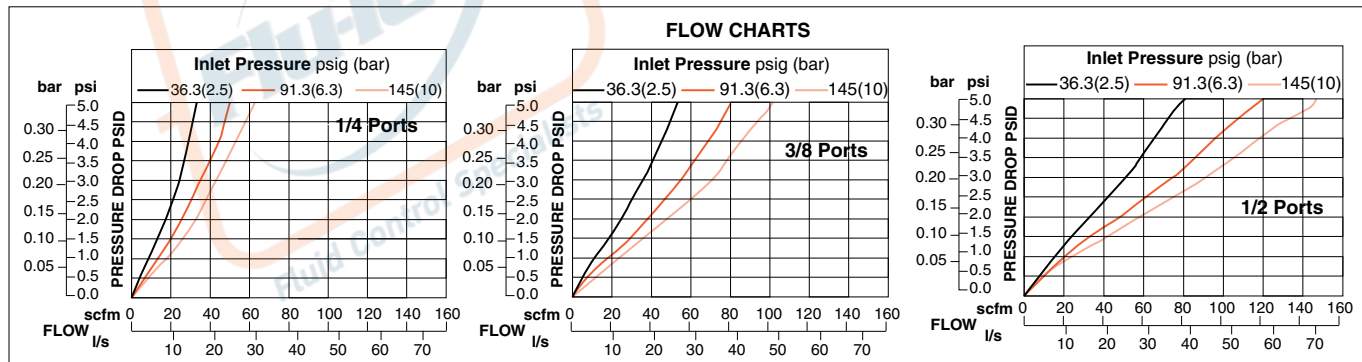

G

Accessories ordered separately, refer to page G6.3-5.

STANDARD SPECIFICATIONS (for lubricators on this page):

Construction Design	Sight-Feed	Oil Adjustment	External, tamper-resistant
Temperature	Ambient/Media: Polycarbonate Bowl: 40° to 125°F (4° to 52°C) Metal Bowl: 40° to 175°F (4° to 80°C)	Construction Material	Body: Zinc Bowl: Polycarbonate with nylon shatterguard, or aluminum bowl with clear nylon sight glass Sight Dome: Nylon Seals: Nitrile
Fluid Media	Compressed air		
Operating Pressure	Polycarbonate Bowl: Maximum 150 psig (10 bar) Metal Bowl: Maximum 250 psig (17 bar)		



บริษัท ฟลูเทค จำกัด
FLU-TECH CO.,LTD

845/3-4 หมู่ 3 ถ.เทพารักษ์ ต.เทพารักษ์ อ.เมือง จ.สมุทรปราการ 10270
845/3-4 Thepharak RD., T.Thepharak, A.Muang, Samutprakarn 10270 THAILAND
Tel. 0 2384 6060, Fax 0 2384 5701, Email : sales@flutech.co.th, www.flutech.co.th

Port Sizes: 1/4, 3/8, 1/2 & 3/4 – Flow to 140 scfm



Port Size	Sight-Feed				Wick-Feed			
	Polycarbonate Bowl				Metal Bowl			
	Model Number		Model Number		Model Number		Model Number	
	NPTF Threads	G Threads	NPTF Threads	G Threads	NPTF Threads	G Threads	NPTF Threads	G Threads
With Fill Port								
1/4	5111B2008	C5111B2008	5112B2008	C5112B2008	5111B2014	C5111B2014	5112B2014	C5112B2014
3/8	5111B3008	C5111B3008	5112B3008	C5112B3008	5111B3014	C5111B3014	5112B3014	C5112B3014
1/2	5111B4008	C5111B4008	5112B4008	C5112B4008	5111B4014	C5111B4014	5112B4014	C5112B4014
3/4	5111B5008	C5111B5008	5112B5008	C5112B5008	5111B5014	C5111B5014	5112B5014	C5112B5014
With Quick-Fill Cap								
1/4	5111B2108	C5111B2108	5112B2108	C5112B2108	5111B2114	C5111B2114	5112B2114	C5112B2114
3/8	5111B3108	C5111B3108	5112B3108	C5112B3108	5111B3114	C5111B3114	5112B3114	C5112B3114
1/2	5111B4108	C5111B4108	5112B4108	C5112B4108	5111B4114	C5111B4114	5112B4114	C5112B4114
3/4	5111B5108	C5111B5108	5112B5108	C5112B5108	5111B5114	C5111B5114	5112B5114	C5112B5114

Port Size	Bowl Type	Bowl Capacity	Dimensions inches (mm)				Weight lb (kg)
			A	B**	C	Depth	
With Sight-Feed							
1/4, 3/8, 1/2, 3/4	Polycarbonate	8-oz (240-ml)	3.5 (88)	5.2 (132)	1.3 (32)	3.5 (89)	2.06 (0.94)
	Zinc	8-oz (240-ml)	3.5 (88)	5.3 (135)	1.3 (32)	3.5 (89)	2.90 (1.32)
With Wick-Feed							
1/4, 3/8, 1/2, 3/4	Polycarbonate	8-oz (240-ml)	3.5 (88)	5.2 (132)	0.7 (17)	3.5 (89)	2.25 (1.02)
	Zinc	8-oz (240-ml)	3.5 (88)	5.3 (135)	0.7 (17)	3.5 (89)	2.85 (1.30)

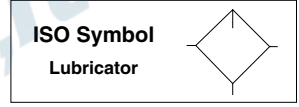
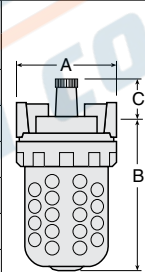

** Bowl removal clearance: add 3.1 (79).

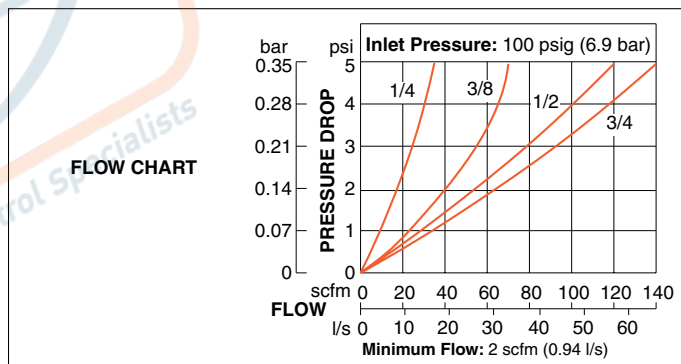

Accessories ordered separately, refer to page G6.3-4.

STANDARD SPECIFICATIONS (for lubricators on this page):

Construction Design	Sight-Feed or Wick-Feed	Construction Material	Adjusting Knob: Acetal
Temperature	Ambient/Media: Polycarbonate Bowl: 40° to 125°F (4° to 52°C) Metal Bowl: 40° to 175°F (4° to 80°C)		Body: Zinc
Fluid Media	Compressed air		Bowl: Polycarbonate with steel shatterguard, or zinc bowl with sight glass
Operating Pressure	Polycarbonate Bowl: Maximum 150 psig (10 bar) Metal Bowl: Maximum 200 psig (14 bar)		Bowl Ring: Aluminum
Oil Adjustment	External, tamper-resistant		Sight Dome: Nylon; External, tamper-proof
			Seals: Nitrile



บริษัท ฟลูเทค จำกัด
FLU-TECH CO.,LTD

845/3-4 หมู่ 3 ถ.เทพารักษ์ ต.เทพารักษ์ อ.เมือง จ.สมุทรปราการ 10270
845/3-4 Thepharak RD., T.Thepharak, A.Muang, Samutprakarn 10270 THAILAND
Tel. 0 2384 6060, Fax 0 2384 5701, Email : sales@flutech.co.th, www.flutech.co.th

Port Sizes: 3/8, 1/2 & 3/4 – Flow to 205 scfm

Choose your options (in red) to configure your model number.

MD4 **51P** **S** **B** **3** **2**

BOWL MATERIAL/SIZE	
Polycarbonate Bowl 9-oz (266-ml)	51P
Metal Bowl 9-oz (266-ml)	51M
Extended Metal Bowl 15-oz (443-ml)	51E

LUBRICATOR FILL TYPE	
Quick Fill Cap	Q
Fill Port	S

PIPE SIZE	
3/8 NPTF	3
1/2 NPTF	4
3/4 NPTF	5
3/8 G	C
1/2 G	D
3/4 G	E

CAP COLOR	
Black	2
Yellow	Y



Bowl Size	Bowl Type	Dimensions inches (mm)				Weight lb (kg)
		A	B**	C	Depth	
3/8, 1/2, 3/4	Polycarbonate	3.5 (88)	7.1 (179)	2.2 (56)	2.9 (73)	2.0 (0.91)
	Aluminum	3.5 (88)	7.4 (188)	2.2 (56)	3.1 (79)	2.0 (0.91)

** Bowl removal clearance: add 3.1 (79).
Extended Bowl removal clearance: add 6.1 (155).

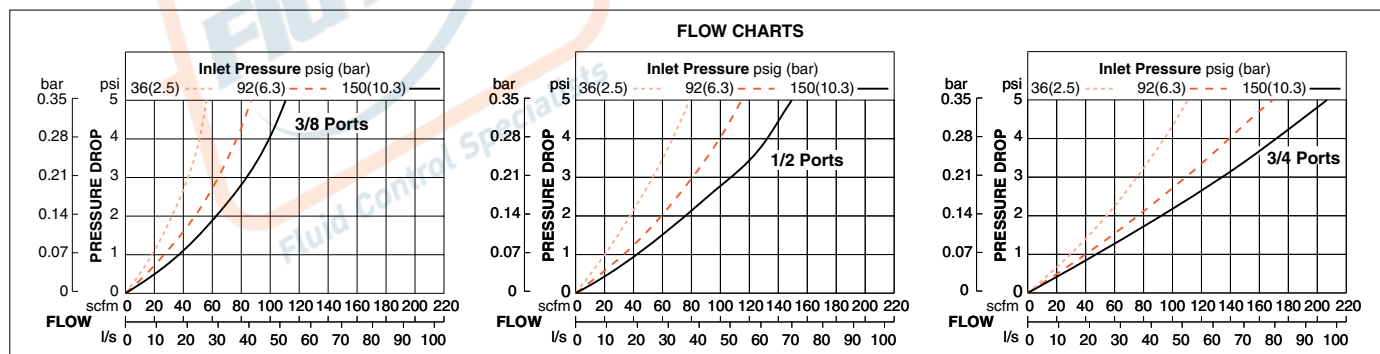
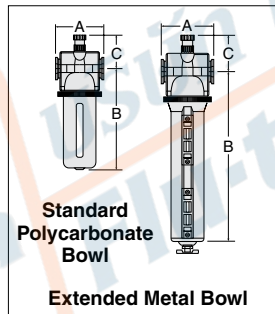
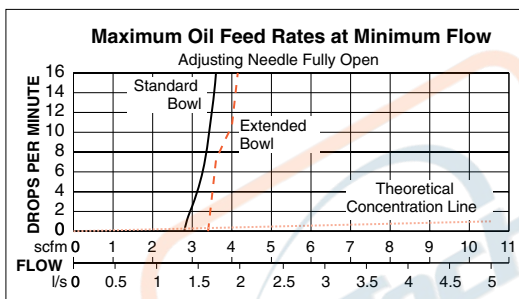

Accessories ordered separately, refer to page G6.3-4.

STANDARD SPECIFICATIONS (for lubricators on this page):

Construction Design	Sight-Feed	Construction Material	Body: Zinc
Temperature	Ambient/Media: Polycarbonate Bowl: 40° to 125°F (4° to 52°C) Metal Bowl: 40° to 175°F (4° to 80°C)		Bowl: Polycarbonate with steel shatterguard, aluminum bowl with clear nylon sight glass, or extended aluminum bowl with two clear nylon sight glass
Fluid Media	Compressed air		Bowl Ring: Nylon
Operating Pressure	Polycarbonate Bowl: Maximum 150 psig (10 bar) Metal Bowl: Maximum 200 psig (14 bar)		Sight Dome: Nylon
Oil Adjustment	External, tamper-resistant		Seals: Nitrile



บริษัท ฟลูเทค จำกัด
FLU-TECH CO.,LTD

845/3-4 หมู่ 3 ถ.เทพารักษ์ ต.เทพารักษ์ อ.เมือง จ.สมุทรปราการ 10270
845/3-4 Thepharak RD., T.Thepharak, A.Muang, Samutprakarn 10270 THAILAND
Tel. 0 2384 6060, Fax 0 2384 5701, Email : sales@flutech.co.th, www.flutech.co.th

Port Sizes: 3/4, 1, 1 1/4 & 1 1/2 – Flow to 500 scfm

Port Size	Bowl Size oz (ml)	Fill-Port				Quick-Fill Cap			
		Sight-Feed		Wick-Feed		Sight-Feed		Wick-Feed	
		Metal Bowl		Metal Bowl		Metal Bowl		Metal Bowl	
		Model Number		Model Number		Model Number		Model Number	
		NPTF Threads	G Threads	NPTF Threads	G Threads	NPTF Threads	G Threads	NPTF Threads	G Threads
3/4	16 (473.2)	5112B5009	C5112B5009	—	—	5112B5109	C5112B5109	—	—
	35 (1035.1)	5112B5019	C5112B5019	—	—	5112B5119	C5112B5119	—	—
	62 (1833.6)	5112B5029	C5112B5029	—	—	5112B5129	C5112B5129	—	—
1	16 (473.2)	5112B6009	C5112B6009	5112B6011	C5112B6011	5112B6109	C5112B6109	5112B6111	C5112B6111
	35 (1035.1)	5112B6019	C5112B6019	—	—	5112B6119	C5112B6119	—	—
	62 (1833.6)	5112B6029	C5112B6029	—	—	5112B6129	C5112B6129	—	—
1 1/4	16 (473.2)	5112B7009	C5112B7009	—	—	5112B7109	C5112B7109	—	—
	35 (1035.1)	5112B7019	C5112B7019	—	—	5112B7119	C5112B7119	—	—
	62 (1833.6)	5112B7029	C5112B7029	—	—	5112B7129	C5112B7129	—	—
1 1/2	16 (473.2)	5112B8009	C5112B8009	—	—	5112B8109	C5112B8109	—	—
	35 (1035.1)	5112B8019	C5112B8019	—	—	5112B8119	C5112B8119	—	—
	62 (1833.6)	5112B8029	C5112B8029	—	—	5112B8129	C5112B8129	—	—
Port Size	Bowl Size oz (ml)	Polycarbonate Bowl							
3/4	16 (473.2)	5111B5009	C5111B5009	—	—	5111B5109	C5111B5109	—	—
1	16 (473.2)	5111B6009	C5111B6009	5111B6011	C5111B6011	5111B6109	C5111B6109	5111B6111	C5111B6111
1 1/4	16 (473.2)	5111B7009	C5111B7009	—	—	5111B7109	C5111B7109	—	—
1 1/2	16 (473.2)	5111B8009	C5111B8009	—	—	5111B8109	C5111B8109	—	—



Metal Bowl

Polycarbonate Bowl

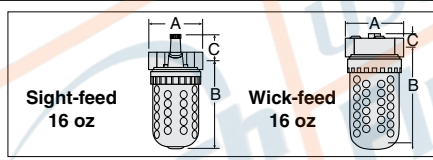

Port Size	Bowl Type	Dimensions inches (mm)				Weight lb (kg)
		A	B**	C	Depth	
With Sight-Feed, 16 oz (473.2 ml)						
3/4, 1, 1 1/4, 1 1/2	Polycarbonate	4.3 (108)	8.2 (208)	1.4 (37)	4.2 (106)	2.63 (1.21)
	Aluminum	4.3 (108)	7.3 (185)	1.4 (37)	4.2 (106)	2.85 (1.30)
With Wick-Feed, 16 oz (473.2 ml)						
3/4, 1, 1 1/4, 1 1/2	Polycarbonate	4.5 (114)	7.7 (195)	0.8 (21)	4.3 (108)	2.88 (1.31)
	Aluminum	4.5 (114)	8.2 (208)	0.8 (21)	4.3 (108)	3.00 (1.36)
With Sight-Feed, 35 oz (1035.1 ml)						
3/4, 1	Aluminum	4.3 (108)	10.2 (259)	2.0 (51)	4.2 (106)	2.56 (1.16)
1 1/4, 1 1/2	Aluminum	4.3 (108)	10.6 (268)	1.6 (41)	4.2 (106)	2.53 (1.16)
Extended Bowls, 35oz (1035ml)						
3/4, 1	Aluminum	4.3 (108)	15.8 (400)	2.0 (51)	4.2 (106)	3.38 (1.64)
1 1/4, 1 1/2	Aluminum	4.3 (108)	16.1 (410)	1.6 (41)	4.2 (106)	3.38 (1.64)

** Bowl removal clearance: add 3.1 (79).

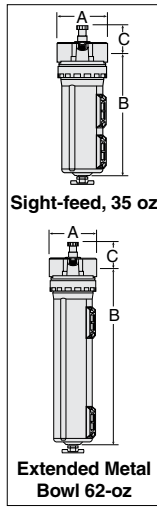

Sight-feed, 35 oz

Extended Metal Bowl 62-oz

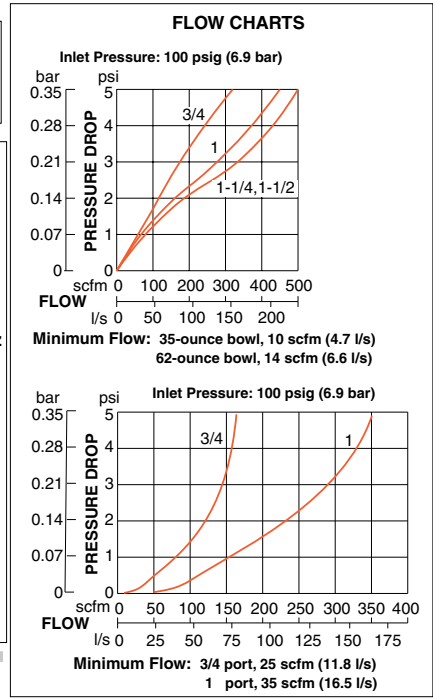

Accessories ordered separately, refer to page G6.3-4.

STANDARD SPECIFICATIONS (for lubricators on this page):

Construction Design	Sight-Feed	Construction Material	Body: Zinc
Temperature	Ambient/Media: Polycarbonate Bowl: 40° to 125°F (4° to 52°C) Metal Bowl: 40° to 175°F (4° to 80°C)		Bowl: Polycarbonate with steel shatterguard, aluminum bowl with clear nylon sight glass, or extended aluminum bowl with two clear nylon sight glass
Fluid Media	Compressed air		Bowl Ring: Nylon
Operating Pressure	Polycarbonate Bowl: Maximum 150 psig (10 bar) Metal Bowl: Maximum 200 psig (14 bar)		Sight Dome: Nylon
Oil Adjustment	External, tamper-resistant		Seals: Nitrile



บริษัท ฟลูเทค จำกัด
FLU-TECH CO.,LTD

845/3-4 หมู่ 3 ถ.เทพารักษ์ ต.เทพารักษ์ อ.เมือง จ.สมุทรปราการ 10270
845/3-4 Thepharak RD., T.Thepharak, A.Muang, Samutprakarn 10270 THAILAND
Tel. 0 2384 6060, Fax 0 2384 5701, Email : sales@flutech.co.th, www.flutech.co.th

G4

G

Mounting Screws for BANTAM Models

Usage Models	Kit Number
BANTAM	859K77

BANTAM models mounts with long screws that extend through end plates.

Mounting Brackets for Regulators and Integrated Filter/Regulators

Regulators and integrated filter/regulators can be mounted to a surface with a bracket that attaches to the regulator. Brackets and mounting panel nuts can be ordered separately or in a kit which includes both bracket and mounting panel nut.

Usage Models	Model Number			Dimensions inches (mm)					Panel Mounting Hole Diameter
	Kit	Bracket	Panel Nut	A	B	C	D	E	
MINIATURE	873K77	872K77	874K77	1.375 (35)	1.125 (29)	0.31 (8)	0.31 (8)	0.69 (17)	1.19 (30)
MID-SIZE	876K77	875K77	877K77	2.38 (60)	1.00 (25)	1.50 (38)	-	-	1.56 (40)
MD3™	R-A127-11	-	R-127-11	2.38 (60)	1.00 (25)	1.50 (38)	-	-	2.06 (52)
FULL-SIZE, MD4™	879K77	878K77	880K77						

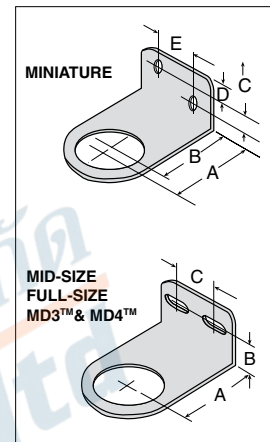

Modular Mounting Brackets for Filters, Regulators, Lubricators, FRL's, or Clean Air Packages

Two L-shaped metal brackets as shown at the right can be used for wall mounting of modular FRLs or Clean Air Packages. A single bracket can be used to mount individual filters or lubricators. Kits include two brackets and four screws for attaching the brackets to the modules.

Usage Models	Kit Number	Dimensions inches (mm)			
		A	B	C	D
MID-SIZE & FULL-SIZE	915K77	3.0 (76)	0.88 (22)	1.00 (25)	1.20 (31)

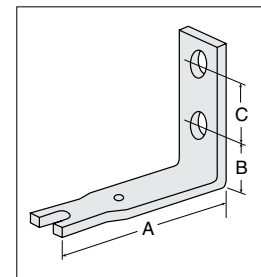

FRLs In-line Mounting Pipe Brackets

Two pipe brackets can be used for wall mounting of FRLs assemblies that use pipe nipples to join the components. The bracket kits listed below include two sets of brackets.

Nipple Size	Kit Number	Dimensions inches (mm)		
		A	B	C
1/4	887K77	2.72 (28)	0.50 (13)	1.00 (25)
3/8	888K77			
1/2	889K77			
3/4	890K77	3.69 (94)	1.13 (29)	1.25 (32)
1	891K77			

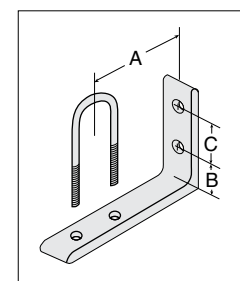

Bracket Assembly Kit for HIGH-RELIEF Pilot Operated Regulator

High-Relief Pilot Operated Regulator with 1/4- thru 1 1/4 inch ports can be mounted to a vertical surface using a bracket assembly kit.

Kit Number	R-A37-381
------------	-----------



MID-SIZE and FULL-SIZE Units

The modular designs of the MID-SIZE and FULL-SIZE series offer maximum flexibility in customizing FRLs assemblies. As shown at the right, connector kits are required to interconnect units. Various port kits (shown below) can be used to connect the assemblies to the inlet and outlet piping. Note that all FRLs components have threaded ports so that conventional pipe fittings may be used where desired.

Female Port Block

Used to connect to piping at inlet or outlet.

Port Size	Model Number	
	NPTF Threads	G Threads
1/4	897K77	D897K77
3/8	898K77	D898K77
1/2	899K77	D899K77
3/4	900K77	D900K77



Male Port Block

Used to connect modular to non-modular units.

Port Size	Model Number	
	NPTF Threads	G Threads
1/4	893K77	D893K77
3/8	894K77	D894K77
1/2	895K77	D895K77
3/4	896K77	D896K77



Connector Kit

Used to connect units to one another as well as to any of the ports shown on this page.

Kit Number 892K77

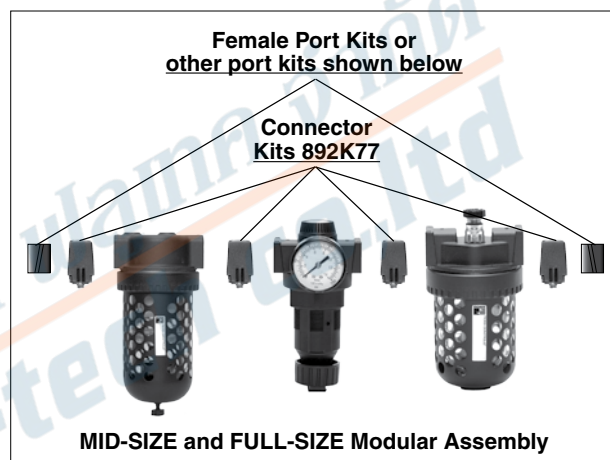

BANTAM Units

BANTAM modular units use end plates secured with screws to hold the pipe or tubing ports (see below), and also to serve as mounting brackets. Short screws are used to secure the end plates when a single BANTAM unit is used. If two or more units are combined, long screws extend through an end plate and thread into the next unit.

Screw kits required are as follows:

Single Unit: Two short screw kits.

Two-Unit Combination: One each short screw kit and long screw kit.

Three-Unit Combination: Two long screw kits.

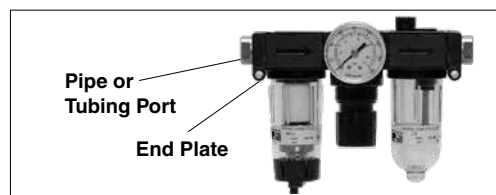

Pipe Ports	
Port Size	Model Number
1/8 NPTF	862K77
1/4 NPTF	863K77
1/8 BSPP	D864K77
1/4 BSPP	D865K77

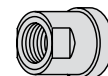

Pipe Ports	
Kit Description	Model Number
END PLATE (1)	857K77
Short Screw (2)	858K77
Long Screw (2)	859K77
Small O-Ring (for inlet or mating ports)	860K77
Large O-Ring (for outlet or mating ports)	861K77

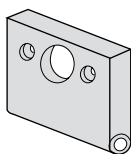

Tube Ports	
Port Size	Model Number
1/4	866K77
3/8	867K77
4 mm	868K77
6 mm	869K77
8 mm	870K77
10 mm	871K77

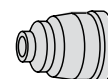

Modular Assemblies

Accessories: Clamp, Brackets, End Ports & Port Blocks

MD Series

Dimensions: inches (mm)

MD3™ Series

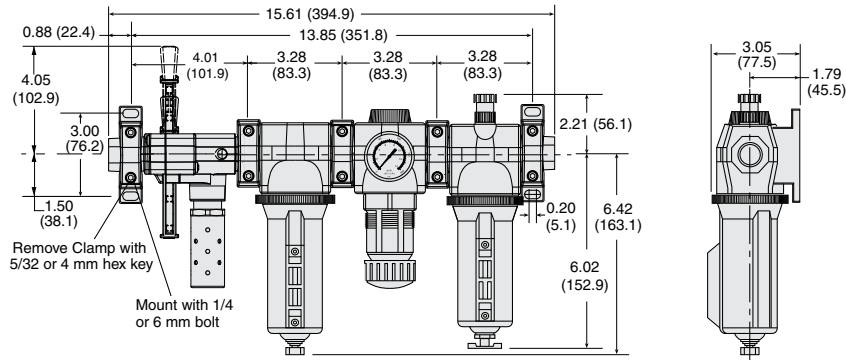

MD4™ Series

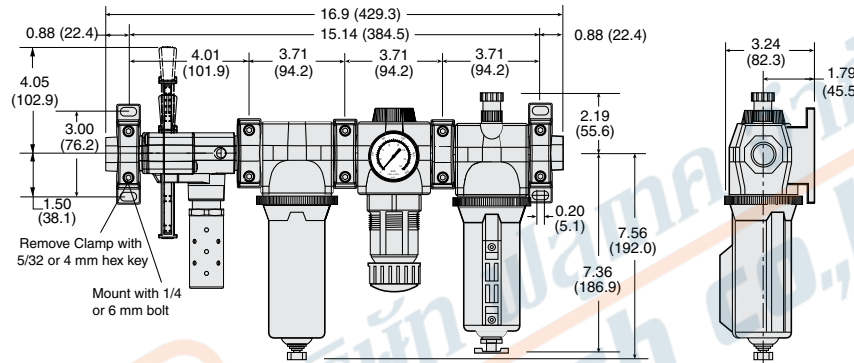

Mounting Brackets & Clamp for Module Connections

Two brackets are normally used to mount an FRL to a vertical surface. The mounting bracket attaches to the module connecting clamp (see above) with a single screw. Each bracket then employs two bolts (1/4" or 6mm) to connect the assembly to the mounting surface. Specially designed clamps provide a quick and easy assembly or disassembly of MD3™ modules. Two Allen-Head bolts quickly tighten or loosen the clamp using a 5/32 or 4mm hex key. The clamp contains a plate carrying two O-rings to provide positive sealing between modules.



Bracket, Screw, and Clamp



Module Connecting Clamp



Mounting Bracket

Mounting Brackets & Clamp for Module Connections

Description	Model Number
Bracket and Screw	R-A118-103
Module Connecting Clamp	R-A118-105
Bracket, Screw, and Clamp	R-A118-105M

Male and Female End Ports

Either male or female end ports can be attached to threaded inlet and outlet lines. This allows all modules of an FRL assembly to be removed easily and quickly without having to unthread the end modules. The end ports are attached to the modules with clamps (see at left). End ports can be included in an assembled FRL or ordered separately by the following model numbers:

Type	Port Size	Model Number		
		NPTF Threads	G Threads	
Female	1/4	R-118-100-2	R-118-100-2W	
	3/8	R-118-100-3	R-118-100-3W	
	1/2	R-118-100-4	R-118-100-4W	
	3/4	R-118-100-6	R-118-100-6W	
Male	1/4	R-118-109-2F	R-118-109-2FW	
	3/8	R-118-109-3F	R-118-109-3FW	
	1/2	R-118-109-4F	R-118-109-4FW	
	3/4	R-118-109-6F	R-118-109-6FW	

Extra Port Blocks

An extra port block can be placed between modules to provide two auxiliary 1/4 NPTF ports. Its mounting position can be rotated to obtain the most convenient operating orientation. If only one auxiliary port is to be used, the unused port must be closed with a pipe plug. (The inlet and outlet are not threaded.)

Port Size	Model Number	
	NPTF Threads	G Threads
1/4	R-118-106-2	R-118-106-2W
3/8	R-118-106-3	R-118-106-3W
1/2	R-118-106-4	R-118-106-4W



บริษัท ฟลูเทค จำกัด
FLU-TECH CO.,LTD

845/3-4 หมู่ 3 ถ.เทพารักษ์ ต.เทพารักษ์ อ.เมือง จ.สมุทรปราการ 10270
845/3-4 Thepharak RD., T.Thepharak, A.Muang, Samutprakarn 10270 THAILAND
Tel. 0 2384 6060, Fax 0 2384 5701, Email : sales@flutech.co.th, www.flutech.co.th

Analog Pressure Gauges

Pressure Gauges (Center Back Mounting)	Type/Material	Port Size	Model Number		Pressure Range psig (bar)	Case Diameter inches (mm)
			Thread			
			NPT	G		
Standard Aluminum		1/8	5400A1002	D5400A1002	0-160 (0-11)	1.7 (43)
		1/4	5400A2010	D5400A2010	0-60 (0-4)	2.0 (51)
		1/4	5400A2011	D5400A2011	0-200 (0-14)	2.0 (51)
		1/4	5400A2012	D5400A2012	0-300 (0-20)	2.0 (51)
Liquid Filled Stainless Steel		1/4	5400A2014	D5400A2014	0-160 (0-11)	2.5 (64)
		1/4	5400A2015*	D5400A2015*	0-160 (0-11)	2.0 (51)

*Green shade between 40-70 psi (2.7-4.8 bar).

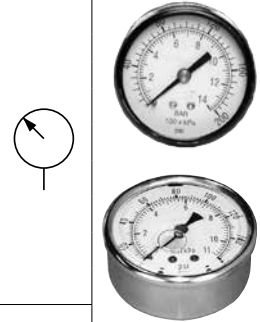

Differential Pressure Gauges

DIFFERENTIAL PRESSURE GAUGE TYPE/SERIES	Small Slide Gauge	Small Slide Gauge	Large Dual Face Gauge	Large Dual Face Gauge with Reed Switch (Normally Open)	Large Dual Face Gauge with Reed Switch (Normally Closed)
	R-A60F-28	R-K103-151	R-106-35	R-106-35E	R-106-35EC
FILTERS					
BANTAM	-	-	-	-	-
MINIATURE	-	-	-	-	-
MID-SIZE	-	-	-	-	-
MD3™	-	-	-	-	-
FULL-SIZE	-	-	-	-	-
MD4™	-	-	-	-	-
HIGH-CAPACITY	-	-	-	-	-
COALESCING FILTERS					
BANTAM	-	-	-	-	-
MINIATURE	-	-	-	-	-
MID-SIZE	-	-	-	-	-
FULL-SIZE	-	-	-	-	-
MD3™	-	-	-	-	-
MD4™	-	-	-	-	-
HIGH-CAPACITY	-	-	-	-	-
OIL VAPOR REMOVAL (ADSORBING) FILTERS					
MD3™	-	-	-	-	-
MD4™	-	-	-	-	-
CLEAN AIR PACKAGES					
MD3™	-	-	-	-	-
MD4™	-	-	-	-	-

G

G6



บริษัท ฟลูเทค จำกัด
FLU-TECH CO.,LTD

845/3-4 หมู่ 3 ถ.เทพารักษ์ ต.เทพารักษ์ อ.เมือง จ.สมุทรปราการ 10270
845/3-4 Thepharak RD., T.Thepharak, A.Muang, Samutprakarn 10270 THAILAND
Tel. 0 2384 6060, Fax 0 2384 5701, Email : sales@flutech.co.th, www.flutech.co.th

External Automatic Drains

Pipe Size	Model Number*	
	Polycarbonate Bowl**	Metal Bowl
1/8	5057B1001	5058B1001
1/4*	5057B2001	5058B2001

*Use 1/4 size with FULL-SIZE, HIGH-CAPACITY, MD3™ & MD4™ filters.
Use kit 1076K77 to convert standard bowl to accept auto drain unit.
**Available for FULL-SIZE filters only. Polycarbonate bowl includes metal bowl guard.

Port Size	Dimensions inches (mm)			Weight lb (kg)
	A	B	C	
1/8, 1/4	3.5 (89)	4.2 (107)	8.3 (211)	2.6 (1.2)

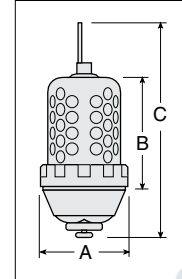

Electronically Controlled Drain

Pipe Size	Voltage	Model Number	
		NPTF Threads	G Threads
1/4	24 volts DC	R-DED-24V-2	R-DED-24V-2W
3/8	24 volts DC	R-DED-24V-3	R-DED-24V-3W
1/2	24 volts DC	R-DED-24V-4	R-DED-24V-4W
1/4	110-120 volts AC, 50/60 Hz	R-DED-115V-2	R-DED-115V-2W
3/8	110-120 volts AC, 50/60 Hz	R-DED-115V-3	R-DED-115V-3W
1/2	110-120 volts AC, 50/60 Hz	R-DED-115V-4	R-DED-115V-4W

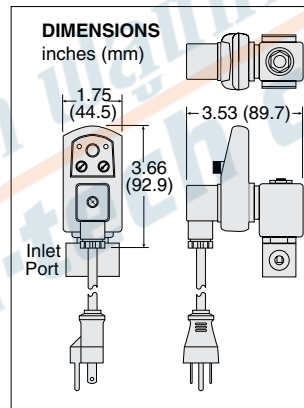

STANDARD SPECIFICATIONS (for electronically controlled drain):

Drain Time	Adjustable 0.5 to 10 seconds	Electrical Connection	DIN 43650A, ISO 440/6952
Drain Interval	0.5 to 45 minutes	Valve Type	2/2 direct acting, normally closed
Current Consumption	Maximum 4 ma	Valve Body	Forged brass; 3/16-inch (4.8 mm) orifice
Temperature	Ambient: 35° to 130°F (2° to 54°C) Media: 35° to 190°F (2° to 88°C)	Maximum Pressure	230 psig (15.8 bar)

Silencers

Port Size	Thread Type	Model Number*		Avg. C _v	Dimensions inches (mm)		Weight lb (kg)
		NPT Threads	R/Rp Threads		Width	Length	
3/8	Male	5500A3003	D5500A3003	4.3	1.3 (32)	3.5 (88)	0.2 (0.1)
3/4	Male	5500A5013	D5500A5013	5.1	1.3 (32)	3.6 (92)	0.2 (0.1)
3/4	Male	5500A5003	D5500A5003	11.5	2.0 (51)	5.3 (135)	0.6 (0.3)

Flow Media: Filtered air.
Pressure Range: 0 to 290 psig (0 to 20 bar) maximum.



G

G6



บริษัท ฟลูเทค จำกัด
FLU-TECH CO.,LTD

845/3-4 หมู่ 3 ถ.เทพารักษ์ ต.เทพารักษ์ อ.เมือง จ.สมุทรปราการ 10270
845/3-4 Thepharak RD., T.Thepharak, A.Muang, Samutprakarn 10270 THAILAND
Tel. 0 2384 6060, Fax 0 2384 5701, Email : sales@flutech.co.th, www.flutech.co.th