



PRODUCT INFORMATION

FILTER, REGULATOR AND LUBRICATOR

COMBINATION UNITS



ROSS CONTROLS

Modular Filter, Regulator and Lubricator Combinations

BANTAM Series

Port Sizes: 1/8 & 1/4 – Flow to 22 scfm

Combination with PISTON Type Regulator - Fill Port Lubricator#				
Port Size	Automatic Drain		Manual Drain	
	Polycarbonate Bowl	Metal Bowl	Polycarbonate Bowl	Metal Bowl
	Model Number	Model Number	Model Number	Model Number
With THREADED PORTS				
1/8 NPTF	5B01C0115	5B01C0216	5B01C0315	5B01C0416
1/8 G	C5B01C0115	C5B01C0216	C5B01C0315	C5B01C0416
1/4 NPTF	5B02C0115	5B02C0216	5B02C0315	5B02C0416
1/4 G	CC5B02C0115	C5B02C0216	C5B02C0315	C5B02C0416
With Quick Connect TUBE FITTINGS				
1/4	5B03C0115	5B03C0216	5B03C0315	5B03C0416
3/8	5B04C0115	5B04C0216	5B04C0315	5B04C0416
4mm	5B05C0115	5B05C0216	5B05C0315	5B05C0416
6mm	5B06C0115	5B06C0216	5B06C0315	5B06C0416
8mm	5B07C0115	5B07C0216	5B07C0315	5B07C0416
10mm	5B08C0115	5B08C0216	5B08C0315	5B08C0416

#Change the ninth digit to "7" for quick fill lubricator cap e.g., 5B01C0117.

Port Size	Dimensions inches (mm)				Weight † lb (kg)
	A	B**	C	Depth †	
1/8, 1/4 (NPTF or G)	6.3 (160)	3.6 (92)	1.7 (43)	3.6 (92)	0.53 (0.24)
Models below have quick-connect tube fittings.					
1/4	6.7 (170)	3.6 (92)	1.7 (43)	3.6 (92)	0.50 (0.23)
3/8	7.2 (183)	3.6 (92)	1.7 (43)	3.6 (92)	0.50 (0.23)
4, 6 mm	6.7 (170)	3.6 (92)	1.7 (43)	3.6 (92)	0.50 (0.23)
8 mm	6.4 (163)	3.6 (92)	1.7 (43)	3.6 (92)	0.50 (0.23)
10 mm	7.2 (183)	3.6 (92)	1.7 (43)	3.6 (92)	0.50 (0.23)

** Dimension for polycarbonate filter bowl; metal bowl is 3.8 (97).
† Less gauge.

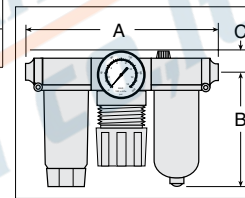
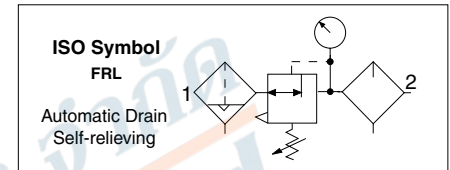

REPLACEMENT FILTER ELEMENTS		
Element Rating	Element Material	Model Number
5-µm - Standard	Polyethylene	933K77
5-µm - Optional	Sintered Bronze	R-KA130-27E5
20-µm - Optional	Sintered Bronze	R-KA130-27E4
40-µm - Optional	Sintered Bronze	R-KA130-27E3

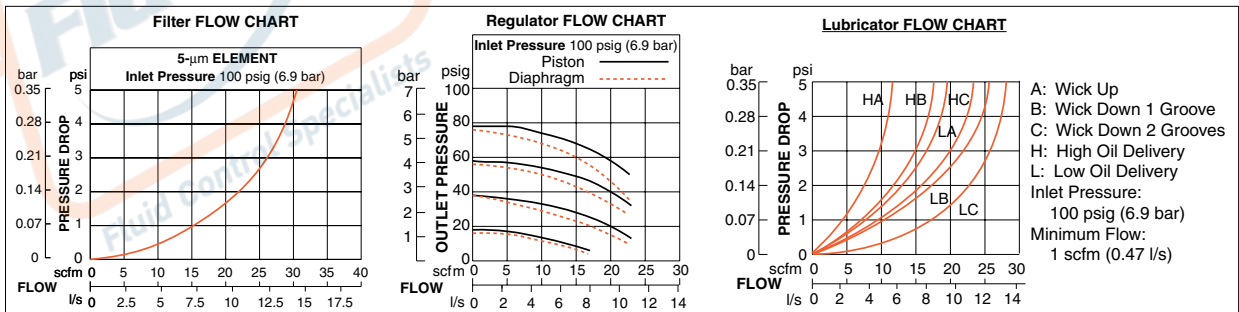

Accessories ordered separately, refer to page G6.3-4.

STANDARD SPECIFICATIONS (for units on this page):

Construction Design	Filter – Fiber Regulator – Piston Lubricator - Wick-Feed	Outlet Pressure	Adjustable up to 100 psig (7 bar)
Temperature	Ambient/Media: Polycarbonate Bowl: 40° to 125°F (4° to 52°C) Metal Bowl: 40° to 175°F (4° to 80°C)	Pressure Adjustment	Locking Key: Removable
Fluid Media	Compressed air	Filter Drain	Internal Automatic or Manual
Operating Pressure	Automatic Drain Models Polycarbonate Bowl: Up to 150 psig (up to 10 bar) Metal Bowl: Up to 200 psig (up to 14 bar)	Pressure Gauge	0 to 60 psig (0 to 11 bar); 1/8 NPT gauge ports front and rear
	Manual Drain Models Polycarbonate Bowl: 0 to 150 psig (0 to 10 bar) Metal Bowl: 0 to 200 psig (0 to 14 bar)	Oil Adjustment	External; no shutoff
		Panel Mounting	1-3/16 inch (30 mm) hole required
		Construction Material	Filter Element: 5-micron rated polyethylene Filter/Regulator & Lubricator Bodies: Acetal Bowls: 2-oz (60-ml) polycarbonate bowls or aluminum bowls Regulator Dome and Knob: Acetal Seals: Nitrile



บริษัท ฟลูเทค จำกัด
FLU-TECH CO.,LTD

845/3-4 หมู่ 3 ถ.เทพารักษ์ ต.เทพารักษ์ อ.เมือง จ.สมุทรปราการ 10270
845/3-4 Thepharak RD., T.Thepharak, A.Muang, Samutprakarn 10270 THAILAND
Tel. 0 2384 6060, Fax 0 2384 5701, Email : sales@flutech.co.th, www.flutech.co.th

G5

G

Modular Filter, Regulator and Lubricator Combinations

BANTAM Series

Port Sizes: 1/8 & 1/4 – Flow to 22 scfm



Combination with DIAPHRAGM Type Regulator - Fill Port Lubricator#

Port Size	Automatic Drain		Manual Drain	
	Polycarbonate Bowl	Metal Bowl	Polycarbonate Bowl	Metal Bowl
	Model Number	Model Number	Model Number	Model Number
With THREADED PORTS*				
1/8 NPTF	5B01C0125	5B01C0226	5B01C0325	5B01C0426
1/8 G	C5B01C0125	C5B01C0226	C5B01C0325	C5B01C0426
1/4 NPTF	5B02C0125	5B02C0226	5B02C0325	5B02C0426
1/4 G	C5B02C0125	C5B02C0226	C5B02C0325	C5B02C0426
With Quick Connect TUBE FITTINGS				
1/4	5B03C0125	5B03C0226	5B03C0325	5B03C0426
3/8	5B04C0125	5B04C0226	5B04C0325	5B04C0426
4mm	5B05C0125	5B05C0226	5B05C0325	5B05C0426
6mm	5B06C0125	5B06C0226	5B06C0325	5B06C0426
8mm	5B07C0125	5B07C0226	5B07C0325	5B07C0426
10mm	5B08C0125	5B08C0226	5B08C0325	5B08C0426

#Change the ninth digit to "7" for quick fill lubricator cap e.g., 5B01C0127.

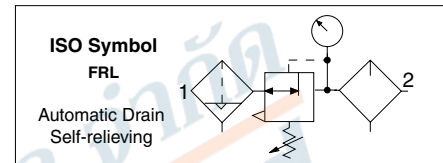

Port Size	Dimensions inches (mm)				Weight † lb (kg)
	A	B**	C	Depth †	
1/8, 1/4	6.3 (160)	3.6 (92)	1.7 (43)	3.6 (92)	0.53 (0.24)

Models below have quick-connect tube fittings.

1/4	6.7 (170)	3.6 (92)	1.7 (43)	3.6 (92)	0.50 (0.23)
3/8	7.2 (183)	3.6 (92)	1.7 (43)	3.6 (92)	0.50 (0.23)
4, 6 mm	6.7 (170)	3.6 (92)	1.7 (43)	3.6 (92)	0.50 (0.23)
8 mm	6.4 (163)	3.6 (92)	1.7 (43)	3.6 (92)	0.50 (0.23)
10 mm	7.2 (183)	3.6 (92)	1.7 (43)	3.6 (92)	0.50 (0.23)

** Dimension for polycarbonate filter bowl; metal bowl is 3.8 (97).
† Less gauge.

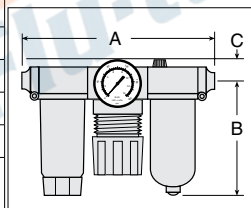

REPLACEMENT FILTER ELEMENTS		
Element Rating	Element Material	Model Number
5-µm - Standard	Polyethylene	933K77
5-µm - Optional	Sintered Bronze	R-KA130-27E5
20-µm - Optional	Sintered Bronze	R-KA130-27E4
40-µm - Optional	Sintered Bronze	R-KA130-27E3

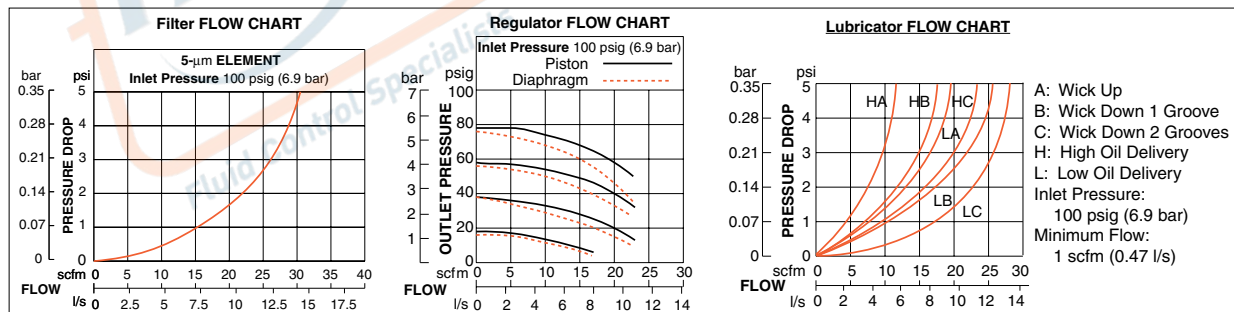

Accessories ordered separately, refer to page G6.3-4.

STANDARD SPECIFICATIONS (for units on this page):

Construction Design	Filter – Fiber Regulator – Diaphragm Lubricator - Wick-Feed	Outlet Pressure	Adjustable up to 100 psig (7 bar)
Temperature	Ambient/Media: Polycarbonate Bowl: 40° to 125°F (4° to 52°C) Metal Bowl: 40° to 175°F (4° to 80°C)	Filter Drain	Internal Automatic or Manual
Fluid Media	Compressed air	Pressure Gauge	0 to 60 psig (0 to 11 bar); 1/8 NPT gauge ports front and rear
Operating Pressure	Automatic Drain Models Polycarbonate Bowl: Up to 150 psig (up to 10 bar) Metal Bowl: Up to 200 psig (up to 14 bar) Manual Drain Models Polycarbonate Bowl: 0 to 150 psig (0 to 10 bar) Metal Bowl: 0 to 200 psig (0 to 14 bar)	Oil Adjustment	External; no shutoff
		Panel Mounting	1-3/16 inch (30 mm) hole required
		Construction Material	Filter Element: 5-micron rated polyethylene Filter/Regulator & Lubricator Bodies: Acetal Bowls: 2-oz (60-ml) polycarbonate bowls or aluminum bowls Regulator Dome and Knob: Acetal Seals: Nitrile



บริษัท ฟลูเทค จำกัด
FLU-TECH CO., LTD

845/3-4 หมู่ 3 ถ.เทพารักษ์ ต.เทพารักษ์ อ.เมือง จ.สมุทรปราการ 10270
845/3-4 Thepharak RD., T.Thepharak, A.Muang, Samutprakarn 10270 THAILAND
Tel. 0 2384 6060, Fax 0 2384 5701, Email : sales@flutech.co.th, www.flutech.co.th

In-line Filter, Regulator and Lubricator Combinations

MINIATURE Series

Port Sizes: 1/8 & 1/4 – Flow to 19 scfm

Port Size	Port Threads	Automatic Drain		Manual Drain	
		Polycarbonate Bowl	Metal Bowl	Polycarbonate Bowl	Metal Bowl
		Model Number	Model Number	Model Number	Model Number
FILL Port Lubricator					
1/8	NPTF	5331C1006	5332C1006	5331C1005	5332C1005
	G	C5331C1006	C5332C1006	C5331C1005	C5332C1005
1/4	NPTF	5331C2006	5332C2006	5331C2005	5332C2005
	G	C5331C2006	C5332C2006	C5331C2005	C5332C2005
With QUICK-FILL CAP					
1/8	NPTF	5331C1106	5332C1106	5331C1105	5332C1105
	G	C5331C1106	C5332C1106	C5331C1105	C5332C1105
1/4	NPTF	5331C2106	5332C2106	5331C2105	5332C2105
	G	C5331C2106	C5332C2106	C5331C2105	C5332C2105

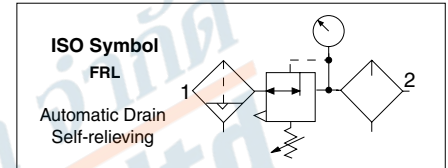

Port Size	Bowl Type	Bowl Capacity	Dimensions inches (mm)				Weight † lb (kg)
			A	B	C	Depth †	
1/8, 1/4	Polycarbonate	2-oz (60-ml)	5.5 (140)	3.6 (90)	0.7 (17)	1.6 (41)	0.76 (0.34)
	Aluminum	2-oz (60-ml)	5.5 (140)	4.3 (109)	0.7 (17)	1.6 (41)	0.76 (0.34)

† Less gauge.

REPLACEMENT FILTER ELEMENTS

Element Rating	Element Material	Model Number
5-µm - Standard	Polyethylene	933K77
5-µm - Optional	Sintered Bronze	R-KA130-27E5
20-µm - Optional	Sintered Bronze	R-KA130-27E4
40-µm - Optional	Sintered Bronze	R-KA130-27E3

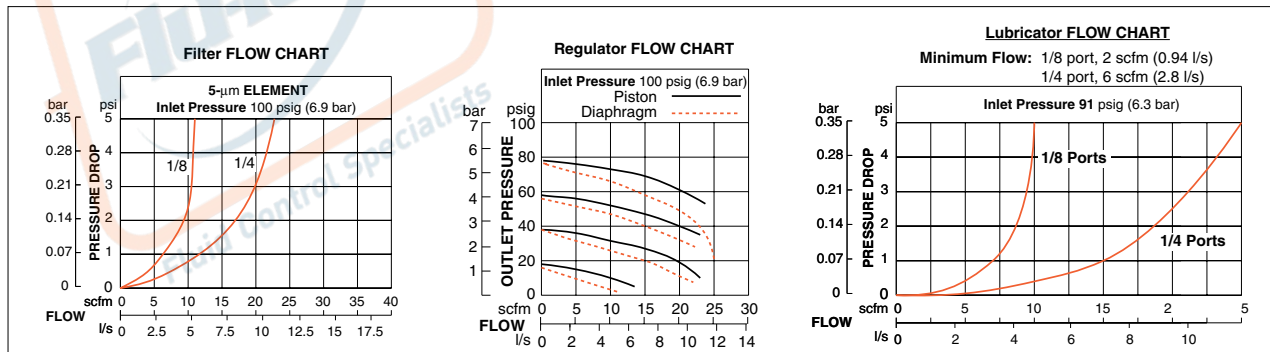
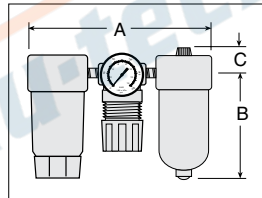

Pressure Gauge included.
Accessories ordered separately, refer to page G6.3-4.

STANDARD SPECIFICATIONS (for units on this page):

Construction Design	Filter – Fiber Regulator – Piston Lubricator - Wick-Feed	Outlet Pressure	Adjustable up to 100 psig (7 bar)
Temperature	Ambient/Media: Polycarbonate Bowl: 40° to 125°F (4° to 52°C) Metal Bowl: 40° to 175°F (4° to 80°C)	Filter Drain	Internal Automatic or Manual
Fluid Media	Compressed air	Pressure Gauge	0 to 60 psig (0 to 11 bar); 1/8 NPT gauge ports front and rear
Operating Pressure	Automatic Drain Models Polycarbonate Bowl: Up to 150 psig (up to 10 bar) Metal Bowl: Up to 200 psig (up to 14 bar)	Oil Adjustment	Internal; tamper-resistant
	Manual Drain Models Polycarbonate Bowl: 0 to 150 psig (0 to 10 bar) Metal Bowl: 0 to 200 psig (0 to 14 bar)	Panel Mounting	1-3/16 inch (30 mm) hole required
		Construction Material	Filter Element: 5-micron rated polyethylene Heads: Aluminum Bowls: Polycarbonate, or Aluminum Regulator Dome and Knob: Acetal Seals: Nitrile



บริษัท ฟลูเทค จำกัด
FLU-TECH CO., LTD

845/3-4 หมู่ 3 ถ.เทพารักษ์ ต.เทพารักษ์ อ.เมือง จ.สมุทรปราการ 10270
845/3-4 Thepharak RD., T.Thepharak, A.Muang, Samutprakarn 10270 THAILAND
Tel. 0 2384 6060, Fax 0 2384 5701, Email : sales@flutech.co.th, www.flutech.co.th

G5

G

Modular Filter, Regulator and Lubricator Combinations

MID-SIZE Series

Port Sizes: 1/4, 3/8 & 1/2 – Flow to 100 scfm

Choose your options (in red) to configure your model number.

 5M 00 B 2 1 0 1

PIPE THREAD	
NPTF (Blank)	
BSP	C

PIPE SIZE	
1/4	2
3/8	3
1/2	4

ADJUSTMENT RANGE	
None	0
0-100 psig (0-6.9 bar)	1
0-50 psig (0-3.4 bar)	3
0-150 psig (0-10 bar)	5

LUBRICATOR BOWL & FILL TYPE	
None	0
Plastic Bowl, Fill Port	1
Metal Bowl, Fill Port	2
Plastic Bowl, Quick-Fill Cap	3
Metal Bowl, Quick-Fill Cap	4

CONNECTIONS	
Pipe In, Out, Between	00
Pipe In & Out, Modular Between	09
Modular, Male Ports In & Out	10
Modular, Female Ports In & Out	11

FILTER BOWL & DRAIN TYPE	
None	0
Plastic Bowl, Automatic Drain	1
Metal Bowl, Automatic Drain	2
Plastic Bowl, Manual Drain	3
Metal Bowl, Manual Drain	4

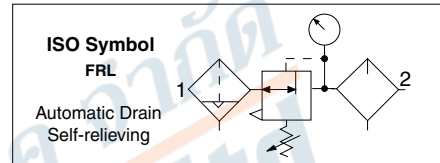

Port Size	Bowl Type	Bowl Capacity	Dimensions* inches (mm)				Weight † lb (kg)
			A	B	C	Depth †	
1/4, 3/8, 1/2	Polycarbonate	4-oz (120-ml)	8.5 (215)	4.6 (117)	1.8 (46)	2.8 (71)	3.75 (1.70)
	Zinc	4-oz (120-ml)	8.5 (215)	4.7 (119)	1.8 (46)	2.8 (71)	3.75 (1.70)

* Dimensions for NPTF Pipe In & Out, Modular Between option; dimensions for other combinations consult ROSS.
† Less gauge.

REPLACEMENT FILTER ELEMENTS		
Element Rating	Element Material	Model Number
5-µm - Standard	Polyethylene	936K77
5-µm - Optional	Sintered Bronze	R-KA60F-03E5
20-µm - Optional	Sintered Bronze	R-KA60F-03E4
40-µm - Optional	Sintered Bronze	R-KA60F-03E3

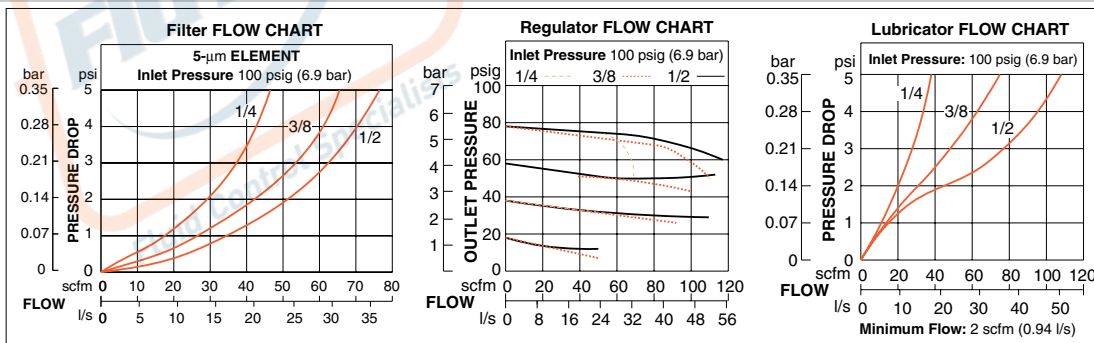
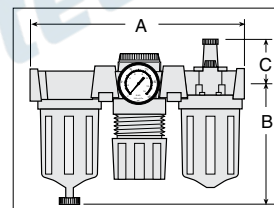

Pressure Gauge included. Includes 2 Female Port Blocks.
Accessories ordered separately, refer to page G6.3-4.

STANDARD SPECIFICATIONS (for units on this page):

Construction Design	Filter – Fiber	Outlet Pressure	Adjustable up to 100 psig (7 bar)
	Regulator – Piston		Filter Drain
Temperature	Lubricator – Sight-Feed	Pressure Gauge	0 to 200 psig (0 to 14 bar); 1/4 NPT gauge ports front and rear.
	Ambient/Media:	Oil Adjustment	External; tamper-resistant
Fluid Media	Polycarbonate Bowl: 40° to 125°F (4° to 52°C)	Panel Mounting	1-9/16 inch (40 mm) hole required
	Metal Bowl: 40° to 175°F (4° to 80°C)	Construction Material	Filter Element: 5-micron rated polyethylene
Operating Pressure	Compressed air		Heads: Zinc
	Automatic Drain Models	Polycarbonate Bowl: Up to 150 psig (up to 10 bar)	Bowls: Polycarbonate bowls with zinc shatterguard, or zinc bowls
Manual Drain Models	Metal bowl: Up to 200 psig (up to 14 bar)	Sight Dome: Clear Nylon	
Polycarbonate bowl: 0 to 150 psig (0 to 10 bar)	Manual Drain Models	Seals: Nitrile	
Metal Bowl: 0 to 200 psig (0 to 14 bar)	Polycarbonate bowl: 0 to 150 psig (0 to 10 bar)		
Metal Bowl: 0 to 200 psig (0 to 14 bar)	Metal Bowl: 0 to 200 psig (0 to 14 bar)		



บริษัท ฟลูเทค จำกัด
FLU-TECH CO., LTD

845/3-4 หมู่ 3 ถ.เทพารักษ์ ต.เทพารักษ์ อ.เมือง จ.สมุทรปราการ 10270
845/3-4 Thepharak RD., T.Thepharak, A.Muang, Samutprakarn 10270 THAILAND
Tel. 0 2384 6060, Fax 0 2384 5701, Email : sales@flutech.co.th, www.flutech.co.th

G5

G

Modular Filter, Regulator and Lubricator Combinations

MD3™ Series

Port Sizes: 1/4, 3/8 & 1/2 – Flow to 110 scfm

Choose your options (in red) to configure your model number.

MD3 53P B A 6 C 2 2 Q 1

BOWLS MATERIAL/SIZE	
Polycarbonate Bowl 5.1-oz (151-ml) - on Filter and Lubricator	53P
Metal Bowls 6-oz (177-ml) - on Filter and Lubricator	53M
Metal Bowl 6-oz (177-ml) - on Filter	53E
Metal Bowl 10-oz (295-ml) - on Lubricator	53F
Plastic Bowl 6-oz (177-ml) - on Filter	53F
Metal Bowl 10-oz (295-ml) - on Lubricator	53F

ADJUSTMENT RANGE	
0-200 psig (0-14 bar)	A*
0-150 psig (0-10.3 bar)	B
0-100 psig (0-6.9 bar)	C
0-50 psig (0-3.4 bar)	D
No Regulator	E
Reverse Flow 0-200 psig (0-14 bar)	F*
Reverse Flow 0-150 psig (0-10.3 bar)	G
Reverse Flow 0-100 psig (0-6.9 bar)	H
Reverse Flow 0-50 psig (0-3.4 bar)	J

*Must be ordered with metal bowl.

FILTER ELEMENT TYPE	
40-µm Sintered Bronze	A
5-µm Polyethylene	B
5-µm Sintered Bronze	E
20-µm Sintered Bronze	F

BOWL DRAIN	
Manual Drain	6
Float Drain	9

PIPE SIZE	
1/4 NPTF	2
3/8 NPTF	3
1/2 NPTF	4
1/4 G	B
3/8 G	C
1/2 G	D

CAP COLOR	
Black	2
Yellow	Y

LUBRICATOR FILL TYPE	
No Lubricator	N
Quick Fill Cap	Q
Fill Port	S

LOCKOUT VALVE	
L-O-X® on outlet side	1
L-O-X® on the inlet side (must also choose Reverse Flow)	2
L-O-X® with EEZ-ON® on outlet side	3
L-O-X® with EEZ-ON® on inlet side (must also choose Reverse Flow)	4
Without Valve - Leave Blank	



REPLACEMENT FILTER ELEMENTS		
Element Rating	Element Material	Model Number
5-µm	Polyethylene	R-A60F-03PE5
	Sintered Bronze	R-A60F-03E5
20-µm	Sintered Bronze	R-A60F-03E4
40-µm	Sintered Bronze	R-A60F-03E3

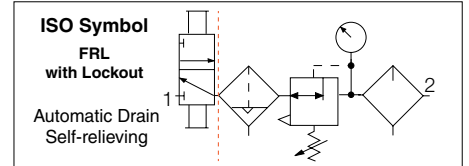

Options: Drains: For additional information, refer to page G6.7.
Accessories ordered separately, refer to page G6.3-5.

STANDARD SPECIFICATIONS (for units on this page):

Construction Design	Filter – Fiber or Sintered Bronze Regulator – Diaphragm Lubricator - Sight-Feed	Pressure Gauge	0 to 200 psig (0 to 14 bar); 1/4 NPT gauge ports front and rear
Temperature	Ambient/Media: Polycarbonate Bowl: 40° to 125°F (4° to 52°C) Metal Bowl: 40° to 175°F (4° to 80°C)	Regulator Pressure	Self-relieving; Non-relieving optional
Fluid Media	Compressed air	Oil Adjustment	External; tamper-resistant
Operating Pressure Filter	Float Drain Models Polycarbonate Bowl: 30 to 150 psig (2 to 10 bar) Metal Bowl: 30 to 200 psig (2 to 14 bar) Manual Drain Models Polycarbonate Bowl: 0 to 150 psig (0 to 10 bar) Metal Bowl: 0 to 250 psig (0 to 17 bar)	Panel Mounting	2-1/16 inch (52 mm) hole required
Operating Pressure Lubricator	Polycarbonate Bowl: Maximum 150 psig (10 bar) Metal Bowl: Maximum 200 psig (17 bar)	Construction Material	Filter Element: 5-micron rated polyethylene; 5-, 20- or 40-micron rated sintered bronze Filter/Regulator & Lubricator Bodies: Zinc Bowls: Polycarbonate with nylon shatterguard, or aluminum bowl with clear nylon sight glass. Lubricator bowl only: extended aluminum bowl with clear nylon sight glass Dome: Nylon Knob: Acetal Sight-Feed Dome: Nylon Seals: Nitrile Valve: Brass
Outlet Pressure	Adjustable up to 200 psig (14 bar); optional adjusting springs		
Optional Pressure Adjustment	Locking Key: Removable		
Filter Drain	Internal Automatic or Manual		



บริษัท ฟลูเทค จำกัด
FLU-TECH CO., LTD

845/3-4 หมู่ 3 ถ.เทพารักษ์ ต.เทพารักษ์ อ.เมือง จ.สมุทรปราการ 10270
845/3-4 Thepharak RD., T.Thepharak, A.Muang, Samutprakarn 10270 THAILAND
Tel. 0 2384 6060, Fax 0 2384 5701, Email : sales@flutech.co.th, www.flutech.co.th

G5

G

Modular Filter, Regulator and Lubricator Combinations

MD3™ Series

Port Size	Bowl Type	Dimensions inches (mm)				Weight lb (kg)
		A	B*	C	Depth	
1/2, 3/8, 1/2	Polycarbonate	9.72 (247.4)	5.54 (140.6)	2.21 (56.2)	2.90 (73.7)	6.1 (2.8)
	Aluminum	9.72 (247.4)	6.42 (163.1)	2.21 (56.2)	2.90 (73.7)	6.4 (2.9)
	Extended Aluminum	9.72 (247.4)	9.37 (238)	2.21 (56.2)	2.90 (73.7)	6.6 (3.0)

Lockout: With the lockout valve, add 2.3 (58) to dimension A.

* Bowl (standard) removal clearance: add 3.1 (79)

* Bowl (extended) removal clearance: add 6.1 (155)

Dimensions above reflect less gauge.

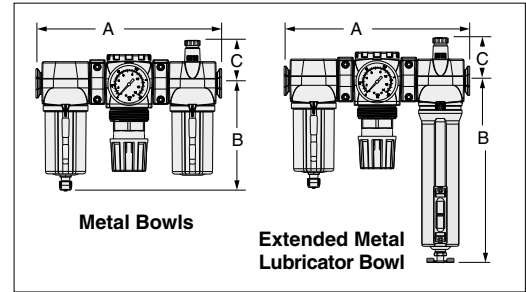

AIR FLOW and CONSTRUCTION DATA

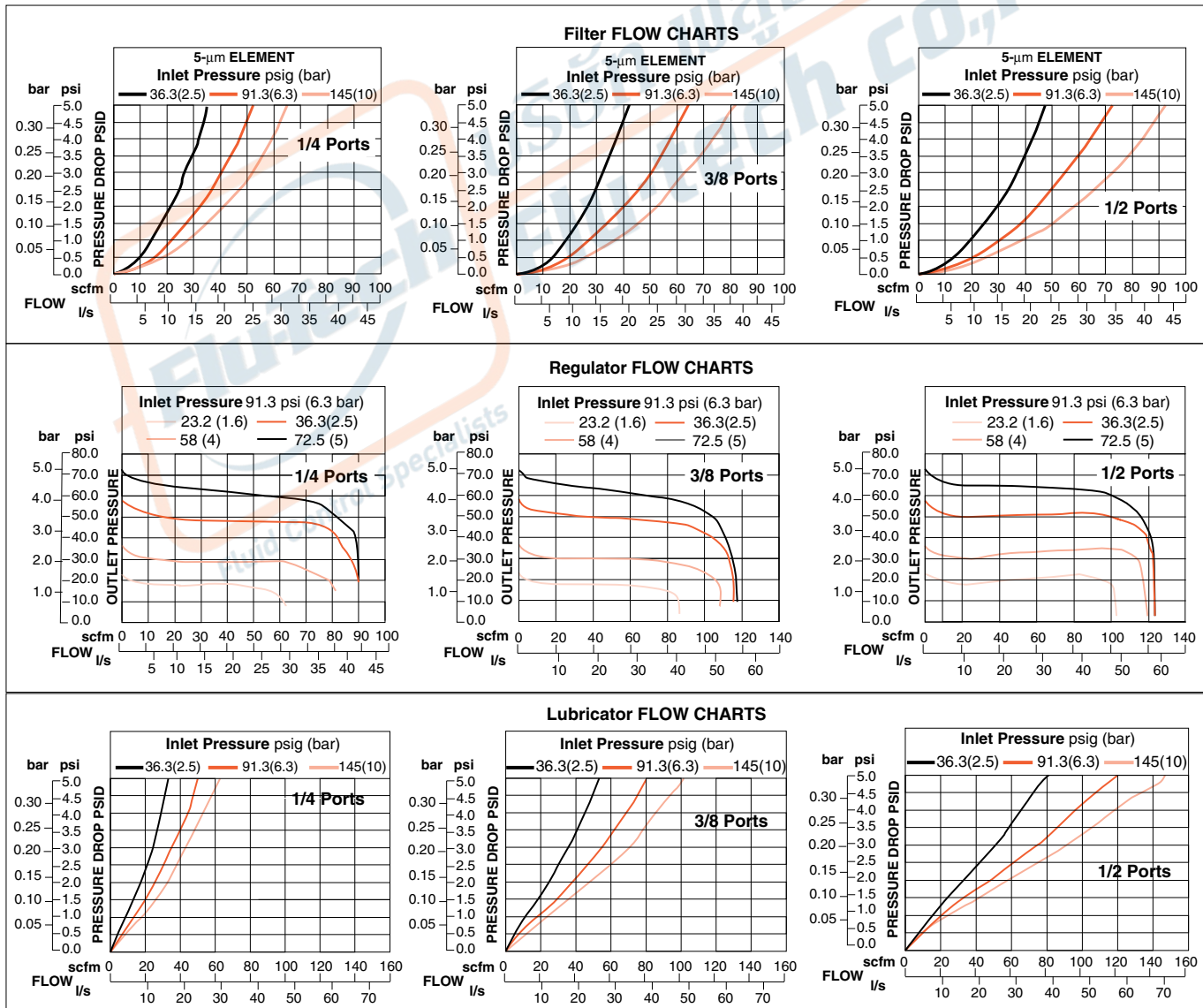

G5

G



บริษัท ฟลูเทค จำกัด
FLU-TECH CO.,LTD

845/3-4 หมู่ 3 ถ.เทพารักษ์ ต.เทพารักษ์ อ.เมือง จ.สมุทรปราการ 10270
845/3-4 Thepharak RD., T.Thepharak, A.Muang, Samutprakarn 10270 THAILAND
Tel. 0 2384 6060, Fax 0 2384 5701, Email : sales@flutech.co.th, www.flutech.co.th

Modular Filter, Regulator and Lubricator Combinations

FULL-SIZE Series

Port Sizes: 1/4, 3/8, 1/2 & 3/4 – Flow to 138 scfm

Choose your options (in red) to configure your model number.

<input type="checkbox"/>	5F	00	B	2	1	0	5
--------------------------	-----------	-----------	----------	----------	----------	----------	----------

PIPE THREAD
NPTF (Blank)
G C

PIPE SIZE
1/4 2
3/8 3
1/2 4
3/4 5

REGULATOR TYPE
ADJUSTMENT RANGE
None 0
0-125 psig (0-8.6 bar) 2
0-50 psig (0-3.4 bar) 4
0-175 psig (0-12 bar) 6

LUBRICATOR FILL & BOWL TYPE
None 0
Sight-Feed, Plastic Bowl, Fill Port 1
Sight-Feed, Metal Bowl, Fill Port 2
Sight-Feed, Plastic Bowl, Quick-Fill Cap 3
Sight-Feed, Metal Bowl, Quick-Fill Cap 4
Sight-Feed, Plastic Bowl, Fill Port 5
Wick-Feed, Metal Bowl, Fill Port 6
Wick-Feed, Plastic Bowl, Quick-Fill Cap 7
Wick-Feed, Metal Bowl, Quick-Fill Cap 8

CONNECTIONS
Pipe In, Out, Between 00
Pipe In & Out, Modular Between 09
Modular, Male Ports In & Out 10
Modular, Female Ports In & Out 11

FILTER DRAIN & BOWL TYPE
None 0
Automatic Drain, Plastic Bowl 1
Automatic Drain, Metal Bowl 2
Manual Drain, Plastic Bowl 3
Manual Drain, Metal Bowl 4

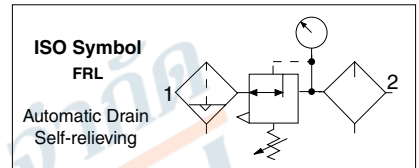

Port Size	Bowl Type	Bowl Capacity	Dimensions* inches (mm)				Weight † lb (kg)
			A	B	C	Depth †	
1/4, 3/8, 1/2, 3/4	Polycarbonate	8-oz (240-ml)	10.1 (256)	5.8 (147)	1.3 (33)	2.8 (71)	7.06 (3.20)
	Zinc	8-oz (240-ml)	10.1 (256)	6.4 (163)	1.3 (33)	2.8 (71)	7.06 (3.20)

* Dimensions for NPTF Pipe In & Out, Modular Between option; dimensions for other combinations consult ROSS. † Less gauge.

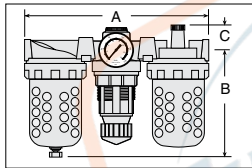

REPLACEMENT FILTER ELEMENTS		
Element Rating	Element Material	Model Number
5-µm - Standard	Polyethylene	939K77
5-µm - Optional	Sintered Bronze	R-KA103-03E5
20-µm - Optional	Sintered Bronze	R-KA103-03E4
40-µm - Optional	Sintered Bronze	R-KA103-03E3

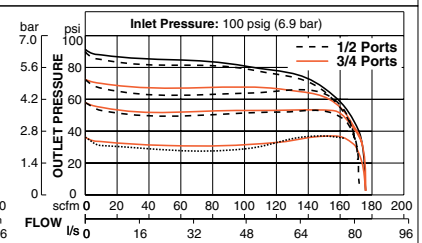
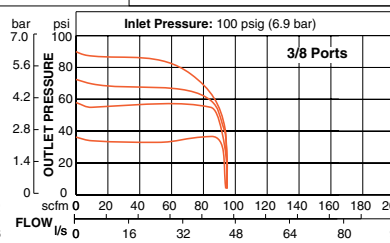
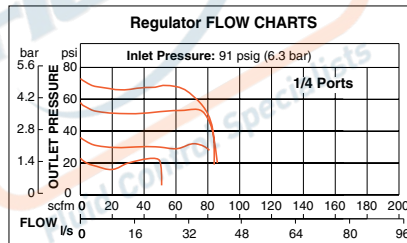
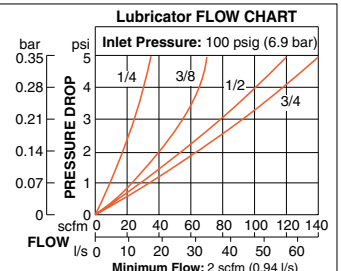
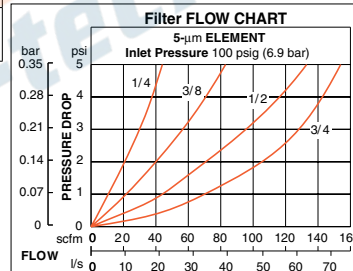

Pressure Gauge included. Units with Threaded Ports Include 2 female port blocks.
Options: Electronic Drain, refer to page G6.7.
Accessories ordered separately, refer to page G6.3-4.

STANDARD SPECIFICATIONS (for units on this page):

Construction Design	Filter – Fiber Regulator – Piston Lubricator - Sight-Feed	Pressure Gauge	0 to 200 psig (0 to 14 bar); 1/4 NPT gauge ports front and rear.
Temperature	Ambient/Media: Polycarbonate Bowl: 40° to 125°F (4° to 52°C) Metal Bowl: 40° to 175°F (4° to 80°C)	Pressure Adjustment	Locking Key: Removable
Fluid Media	Compressed air	Oil Adjustment	External; tamper-resistant
Operating Pressure	Automatic Drain Models Polycarbonate Bowl: 15 to 150 psig (1 to 10 bar) Metal Bowl: 15 to 200 psig (1 to 14 bar)	Panel Mounting	1-9/16 inch (40 mm) hole required
	Manual Drain Models Polycarbonate Bowl: 0 to 150 psig (0 to 10 bar) Metal Bowl: 0 to 200 psig (0 to 14 bar)	Construction Material	Filter Element: 5-micron rated polyethylene Bowls: Zinc bowl with clear nylon sight glass, or polycarbonate bowl with steel shatterguard Bowl Rings: Aluminum Regulator Dome: Nylon Regulator Knob: Acetal Sight Dome: Clear Nylon Seals: Nitrile
Outlet Pressure	Adjustable up to 125 psig (9 bar)		
Filter Drain	Internal Automatic or Manual		



บริษัท ฟลูเทค จำกัด
FLU-TECH CO., LTD

845/3-4 หมู่ 3 ถ.เทพารักษ์ ต.เทพารักษ์ อ.เมือง จ.สมุทรปราการ 10270
845/3-4 Thepharak RD., T.Thepharak, A.Muang, Samutprakarn 10270 THAILAND
Tel. 0 2384 6060, Fax 0 2384 5701, Email : sales@flutech.co.th, www.flutech.co.th

G5

G

Modular Filter, Regulator and Lubricator Combinations

MD4™ Series

Port Sizes: 3/8, 1/2 & 3/4 – Flow to 205 scfm

Choose your options (in red) to configure your model number.

MD4 **53P** **B** **A** **6** **B** **3** **2** **Q** **1**

BOWLS MATERIAL/SIZE	
Polycarbonate Bowls 9-oz (270-ml) - on Filter and Lubricator	53P
Metal Bowls 9-oz (270-ml) - on Filter and Lubricator	53M
Metal Bowl 9-oz (270-ml) - on Filter	53E
Extended Metal Bowl 15-oz (450-ml) - on Lubricator	53E
Plastic Bowl 9-oz (270-ml) - on Filter	53F
Extended Metal Bowl 15-oz (450-ml) - on Lubricator	53F

REGULATOR ADJUSTMENT RANGE	
0-175 psig (0-12 bar)	A*
0-125 psig (0-8.6 bar)	B
0-50 psig (0-3.4 bar)	C
0-20 psig (0-1.4 bar)	D
No Regulator	E
Reverse Flow 0-175 psig (0-12 bar)	F*
Reverse Flow 0-125 psig (0-8.6 bar)	G
Reverse Flow 0-50 psig (0-3.4 bar)	H
Reverse Flow 0-20 psig (0-1.4 bar)	J

*Must be ordered with metal bowl.

PIPE SIZE	
3/8 NPTF	3
1/2 NPTF	4
3/4 NPTF	5
3/8 G	C
1/2 G	D
3/4 G	E

CAP COLOR	
Black	2
Yellow	Y

LUBRICATOR FILL TYPE	
No Lubricator	N
Quick Fill Cap	Q
Fill Port	S

FILTER REGULATOR DRAIN TYPE	
Automatic Drain	5
Manual Drain	6

FILTER ELEMENT TYPE	
40-µm Sintered bronze	A
5-µm Polyethylene	B

LOCKOUT VALVE	
L-O-X® on outlet side	1
L-O-X® on the inlet side (must also choose Reverse Flow)	2
L-O-X® with EEZ-ON® on outlet side	3
L-O-X® with EEZ-ON® on inlet side (must also choose Reverse Flow)	4
Without Valve - Leave Blank	



REPLACEMENT FILTER ELEMENTS		
Element Rating	Element Material	Element Number
5-µm - Standard	Polyethylene	R-A115-106PE5
40-µm - Standard	Sintered Bronze	R-A115-106E3
5-µm - Optional	Sintered Bronze	R-A115-106E5
20-µm - Optional	Sintered Bronze	R-A115-106E4

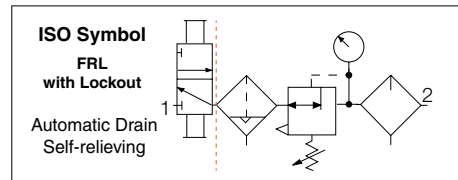

Options: External Bowl Drains, refer to page G6.7.
Accessories ordered separately, refer to page G6.3-5.

STANDARD SPECIFICATIONS (for units on this page):

Construction Design	Filter – Fiber, or Sintered Bronze Regulator – Piston Lubricator – Sight-Feed	Pressure Adjustment	Locking Key: Removable
Temperature	Ambient/Media: Polycarbonate Bowl: 40° to 125°F (4° to 52°C) Metal Bowl: 40° to 175°F (4° to 80°C)	Oil Adjustment	External; tamper-resistant
Fluid Media	Compressed air	Construction Material	Filter Element: 5-micron rated polyethylene or 40-micron element Heads: Zinc Bowls: Aluminum bowl with clear nylon sight glass, polycarbonate bowl with steel shatterguard; extended aluminum lubricator bowl with two clear nylon sight glasses Bowl Rings: Nylon Regulator Dome: Nylon Regulator Knob: Acetal Sight Dome: Clear Nylon Seals: Nitrile
Operating Pressure	Automatic Drain Models Polycarbonate Bowl: 15 to 150 psig (1 to 10 bar) Metal Bowl: 15 to 200 psig (1 to 14 bar) Manual Drain Models Polycarbonate Bowl: 0 to 150 psig (0 to 10 bar) Metal Bowl: 0 to 200 psig (0 to 14 bar)		
Outlet Pressure	Adjustable up to 125 psig (9 bar)		
Filter Drain	Internal Automatic or Manual		
Pressure Gauge	0 to 200 psig (0 to 14 bar); 1/4 NPT gauge ports front and rear.		



บริษัท ฟลูเทค จำกัด
FLU-TECH CO., LTD

845/3-4 หมู่ 3 ถ.เทพารักษ์ ต.เทพารักษ์ อ.เมือง จ.สมุทรปราการ 10270
845/3-4 Thepharak RD., T.Thepharak, A.Muang, Samutprakarn 10270 THAILAND
Tel. 0 2384 6060, Fax 0 2384 5701, Email : sales@flutech.co.th, www.flutech.co.th

G5

G

Modular Filter, Regulator and Lubricator Combinations

MD4™ Series

Port Size	Bowl Type	Dimensions inches (mm)				Weight † lb (kg)
		A	B*	C	Depth †	
3/8, 1/2, 3/4	Polycarbonate	10.9 (276)	7.7 (195)	2.2 (56)	2.9 (73)	6.94 (3.15)
	Aluminum	10.9 (276)	7.6 (193)	2.2 (56)	3.1 (79)	6.94 (3.15)
	Extended Metal	10.9 (276)	10.6 (269)	2.2 (56)	3.1 (79)	7.13 (3.24)

Lockout: With the lockout valve, add 2.3 (58) to dimension A.
 * Bowl (standard) removal clearance: add 4.2 (107).
 * Bowl (extended) removal clearance: add 6.1 (155)
 † Less gauge.

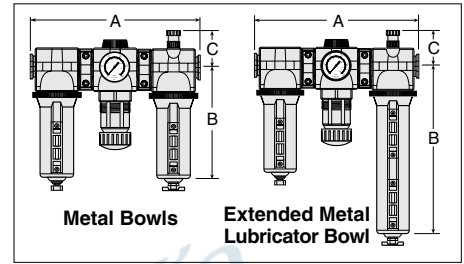

AIR FLOW and CONSTRUCTION DATA

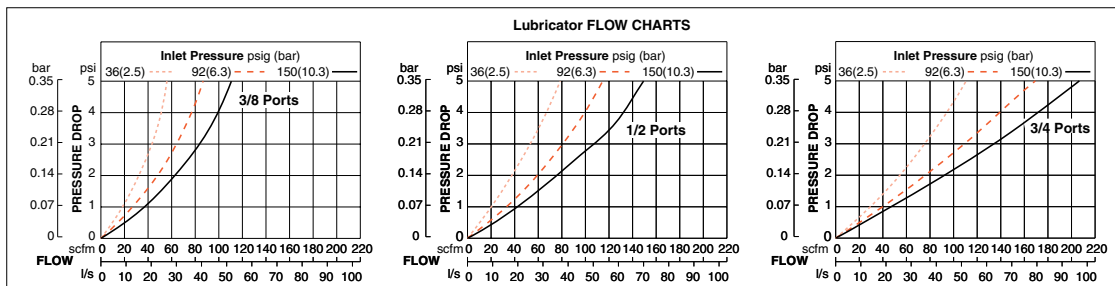
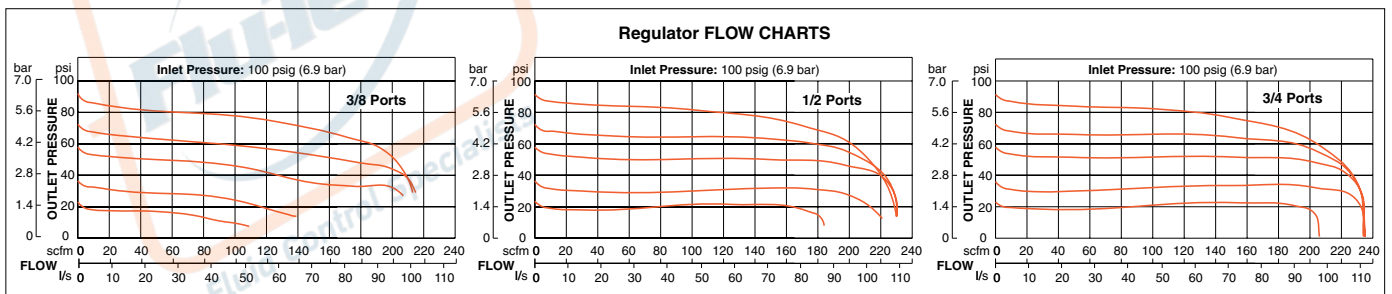
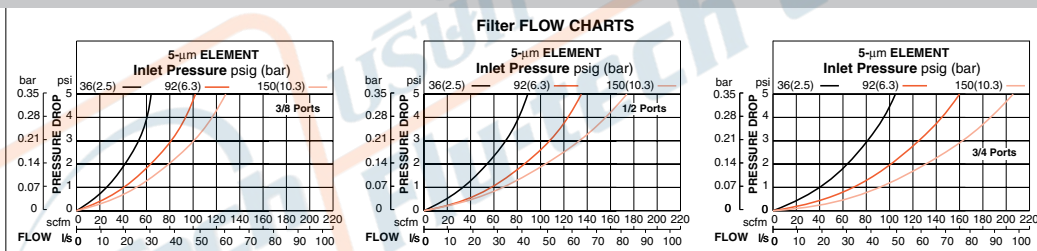

G5

G



บริษัท ฟลูเทค จำกัด
FLU-TECH CO.,LTD

845/3-4 หมู่ 3 ถ.เทพารักษ์ ต.เทพารักษ์ อ.เมือง จ.สมุทรปราการ 10270
 845/3-4 Thepharak RD., T.Thepharak, A.Muang, Samutprakarn 10270 THAILAND
 Tel. 0 2384 6060, Fax 0 2384 5701, Email : sales@flutech.co.th, www.flutech.co.th

In-line Filter, Regulator and Lubricator Combinations

HIGH-CAPACITY Series

Port Sizes: 3/4 & 1 – Flow to 270 scfm

Port Size	Port Threads	Automatic Drain		Manual Drain	
		Polycarbonate Bowl	Metal Bowl	Polycarbonate Bowl	Metal Bowl
		Model Number	Model Number	Model Number	Model Number
3/4	NPTF	5H00C5111	5H00C5212	5H00C5311	5H00C5412
	G	C5H00C5111	C5H00C5212	C5H00C5311	C5H00C5412
1	NPTF	5H00C6111	5H00C6212	5H00C6311	5H00C6412
	G	C5H00C6111	C5H00C6212	C5H00C6311	C5H00C6412



Port Size	Bowl Type	Bowl Capacity	Dimensions inches (mm)				Weight † lb (kg)
			A	B	C	Depth †	
3/4, 1	Polycarbonate	16-oz (480-ml)	15.8 (401)	8.0 (204)	1.2 (31)	4.3 (108)	8.00 (3.64)
	Aluminum	16-oz (480-ml)	15.8 (401)	8.3 (210)	1.2 (31)	4.3 (108)	8.9 (4.03)

† Less gauge.

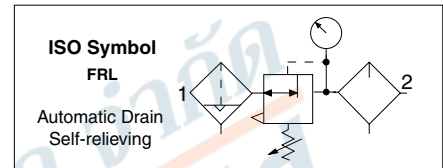

REPLACEMENT FILTER ELEMENTS		
Element Rating	Element Material	Model Number
5-µm - Standard	Polyethylene	1010K77
5-µm - Optional	Sintered Bronze	R-KA109-03E5
20-µm - Optional	Sintered Bronze	R-KA109-03E4
40-µm - Optional	Sintered Bronze	R-KA109-03E3

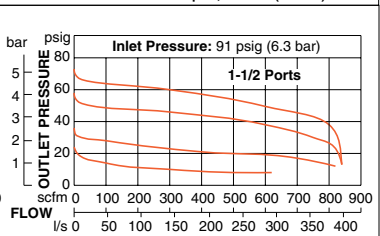
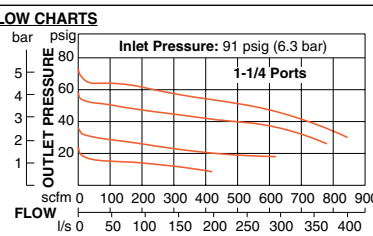
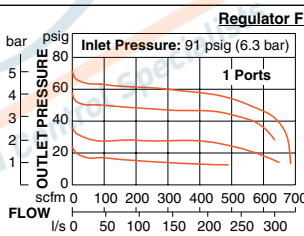
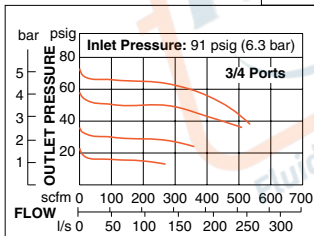
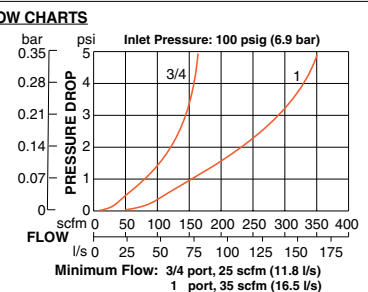
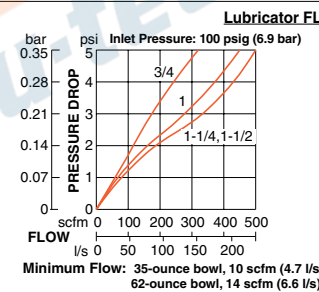
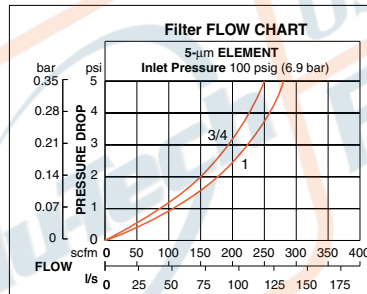
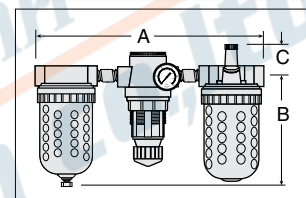

G5

G

Pressure Gauge included.
Accessories ordered separately, refer to page G6.3-4.

STANDARD SPECIFICATIONS (for units on this page):

Construction Design	Filter – Fiber Regulator – Piston Lubricator - Wick-Feed	Pressure Gauge	0 to 200 psig (0 to 14 bar); 1/4 NPT gauge ports front and rear.
Temperature	Ambient/Media: Polycarbonate Bowl: 40° to 125°F (4° to 52°C) Metal Bowl: 40° to 175°F (4° to 80°C)	Pressure Adjustment	Locking Key: Removable
Fluid Media	Compressed air	Oil Adjustment	External; tamper-resistant
Operating Pressure	Automatic Drain Models Polycarbonate Bowl: 15 to 150 psig (1 to 10 bar) Metal Bowl: 15 to 200 psig (1 to 14 bar)	Construction Material	Filter Element: 5-micron rated polyethylene
	Manual Drain Models Polycarbonate Bowl: 0 to 150 psig (0 to 10 bar) Metal Bowl: 0 to 200 psig (0 to 14 bar)		Heads: Aluminum
Outlet Pressure	Adjustable up to 125 psig (9 bar)		Bowls: Aluminum bowls with sight glass, or polycarbonate bowls with steel shatterguard
Filter Drain	Internal Automatic or Manual		Bowl Rings: Aluminum
			Regulator Dome: Nylon
		Regulator Knob: Acetal	
		Sight Dome: Clear Nylon	
		Seals: Nitrile	



บริษัท ฟลูเทค จำกัด
FLU-TECH CO., LTD

845/3-4 หมู่ 3 ถ.เทพารักษ์ ต.เทพารักษ์ อ.เมือง จ.สมุทรปราการ 10270
845/3-4 Thepharak RD., T.Thepharak, A.Muang, Samutprakarn 10270 THAILAND
Tel. 0 2384 6060, Fax 0 2384 5701, Email : sales@flutech.co.th, www.flutech.co.th

In-line Filter, Regulator and Lubricator Combinations

HIGH-CAPACITY Series

Port Sizes: 1¼ & 1½ – Flow to 495 scfm

Choose your options (in red) to configure your model number.

PIPE THREAD	PIPE SIZE	LUBRICATOR TYPE
NPTF (Blank)	1¼ 7	None 0
G C	1½ 8	Sight-feed, Fill port 2
		Sight-feed, Quick-fill cap 4

FILTER DRAIN & ELEMENT TYPE	REGULATOR TYPE
None 0	None 0
Automatic drain, 40-µm 1	Piston, 0-100 psig (0-6.9 bar) 1
Automatic drain, 5-µm 2	Internal pilot, 15-200 psig (1.0-14 bar) 8
Manual drain, 40-µm 3	
Manual drain, 5-µm 4	

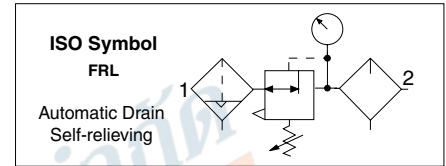

Port Size	Bowl Capacity	Dimensions inches (mm)				Weight† lb (kg)
		A	B	C	Depth†	
1¼, 1½	35-oz (1000-ml)	15.8 (401)	10.6 (268)	2.1 (54)	4.3 (108)	8.00 (3.64)

† Less gauge.

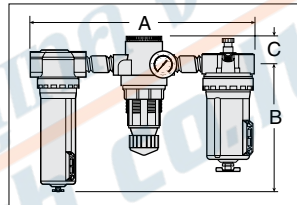

REPLACEMENT FILTER ELEMENTS		
Element Rating	Element Material	Element Number
5-µm	Polyethylene	1656K77
40-µm	Sintered Bronze	R-A114-106E3

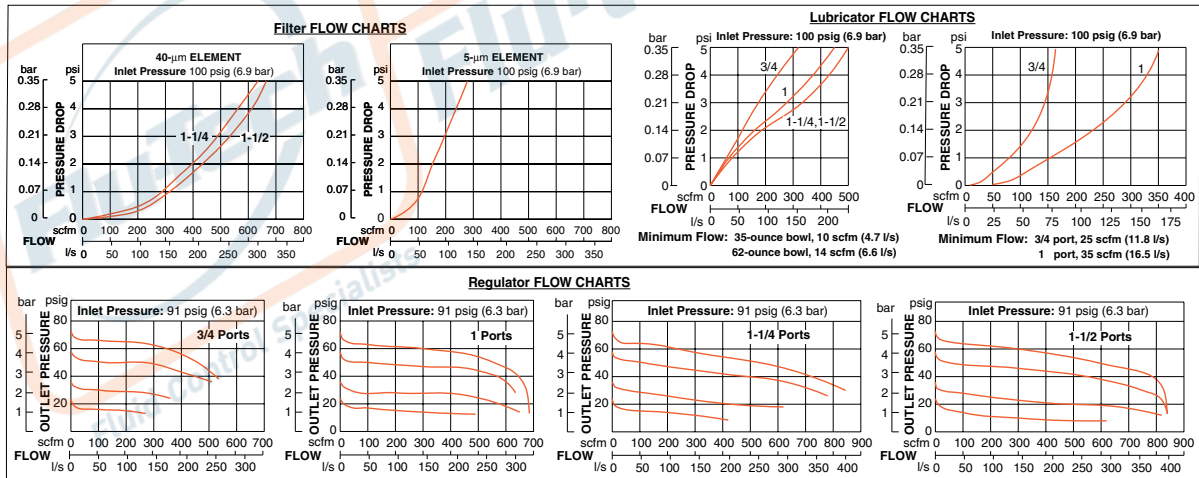

Options: Drains: For additional information, refer to page G6.7.
Accessories ordered separately, refer to page G6.3-4.

STANDARD SPECIFICATIONS (for units on this page):

Construction Design	Filter – Fiber Regulator – Piston Lubricator - Sight-Feed	Construction Material	Filter Element: 5, or 40-micron rated polyethylene
Temperature	Ambient/Media: 40° to 175°F (4° to 79°C)		Heads: Aluminum
Fluid Media	Compressed air		Bowls: Aluminum bowls with sight glass
Operating Pressure	Automatic Drain Models: 15 to 200 psig (1 to 14 bar) Manual Drain Models: 0 to 200 psig (0 to 14 bar)		Bowl Rings: Aluminum
Outlet Pressure	Adjustable up to 100 psig (7 bar)		Regulator Dome: Nylon
Filter Drain	Internal Automatic or Manual		Regulator Knob: Acetal
Pressure Gauge	0 to 200 psig (0 to 14 bar); 1/4 NPT gauge ports front and rear.		Sight Dome: Clear Nylon
Pressure Adjustment	Locking Key: Removable		Seals: Nitrile
Oil Adjustment	External; tamper-resistant		



บริษัท ฟลูเทค จำกัด
FLU-TECH CO., LTD

845/3-4 หมู่ 3 ถ.เทพารักษ์ ต.เทพารักษ์ อ.เมือง จ.สมุทรปราการ 10270
 845/3-4 Thepharak RD., T.Thepharak, A.Muang, Samutprakarn 10270 THAILAND
 Tel. 0 2384 6060, Fax 0 2384 5701, Email : sales@flutech.co.th, www.flutech.co.th

G5

G

Mounting Screws for BANTAM Models

Usage Models	Kit Number
BANTAM	859K77

BANTAM models mounts with long screws that extend through end plates.

Mounting Brackets for Regulators and Integrated Filter/Regulators

Regulators and integrated filter/regulators can be mounted to a surface with a bracket that attaches to the regulator. Brackets and mounting panel nuts can be ordered separately or in a kit which includes both bracket and mounting panel nut.

Usage Models	Model Number			Dimensions inches (mm)					Panel Mounting Hole Diameter
	Kit	Bracket	Panel Nut	A	B	C	D	E	
MINIATURE	873K77	872K77	874K77	1.375 (35)	1.125 (29)	0.31 (8)	0.31 (8)	0.69 (17)	1.19 (30)
MID-SIZE	876K77	875K77	877K77	2.38 (60)	1.00 (25)	1.50 (38)	-	-	1.56 (40)
MD3™	R-A127-11	-	R-127-11	2.38 (60)	1.00 (25)	1.50 (38)	-	-	2.06 (52)
FULL-SIZE, MD4™	879K77	878K77	880K77						

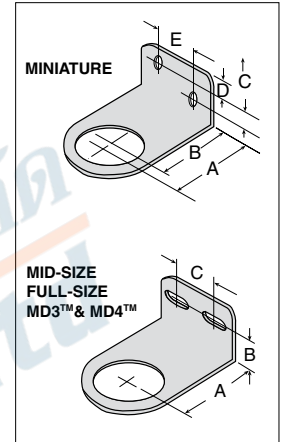

Modular Mounting Brackets for Filters, Regulators, Lubricators, FRL's, or Clean Air Packages

Two L-shaped metal brackets as shown at the right can be used for wall mounting of modular FRLs or Clean Air Packages. A single bracket can be used to mount individual filters or lubricators. Kits include two brackets and four screws for attaching the brackets to the modules.

Usage Models	Kit Number	Dimensions inches (mm)			
		A	B	C	D
MID-SIZE & FULL-SIZE	915K77	3.0 (76)	0.88 (22)	1.00 (25)	1.20 (31)

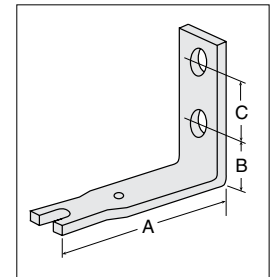

FRLs In-line Mounting Pipe Brackets

Two pipe brackets can be used for wall mounting of FRLs assemblies that use pipe nipples to join the components. The bracket kits listed below include two sets of brackets.

Nipple Size	Kit Number	Dimensions inches (mm)		
		A	B	C
1/4	887K77	2.72 (28)	0.50 (13)	1.00 (25)
3/8	888K77			
1/2	889K77			
3/4	890K77	3.69 (94)	1.13 (29)	1.25 (32)
1	891K77			

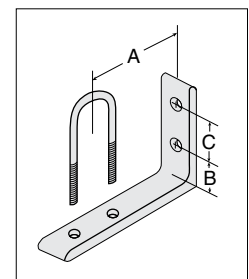

Bracket Assembly Kit for HIGH-RELIEF Pilot Operated Regulator

High-Relief Pilot Operated Regulator with 1/4- thru 1 1/4 inch ports can be mounted to a vertical surface using a bracket assembly kit.

Kit Number	R-A37-381
------------	-----------



MID-SIZE and FULL-SIZE Units

The modular designs of the MID-SIZE and FULL-SIZE series offer maximum flexibility in customizing FRLs assemblies. As shown at the right, connector kits are required to interconnect units. Various port kits (shown below) can be used to connect the assemblies to the inlet and outlet piping. Note that all FRLs components have threaded ports so that conventional pipe fittings may be used where desired.

Female Port Block

Used to connect to piping at inlet or outlet.

Port Size	Model Number	
	NPTF Threads	G Threads
1/4	897K77	D897K77
3/8	898K77	D898K77
1/2	899K77	D899K77
3/4	900K77	D900K77



Male Port Block

Used to connect modular to non-modular units.

Port Size	Model Number	
	NPTF Threads	G Threads
1/4	893K77	D893K77
3/8	894K77	D894K77
1/2	895K77	D895K77
3/4	896K77	D896K77



Connector Kit

Used to connect units to one another as well as to any of the ports shown on this page.

Kit Number 892K77



BANTAM Units

BANTAM modular units use end plates secured with screws to hold the pipe or tubing ports (see below), and also to serve as mounting brackets. Short screws are used to secure the end plates when a single BANTAM unit is used. If two or more units are combined, long screws extend through an end plate and thread into the next unit.

Screw kits required are as follows:

Single Unit: Two short screw kits.

Two-Unit Combination: One each short screw kit and long screw kit.

Three-Unit Combination: Two long screw kits.

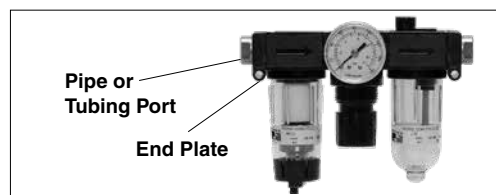

Pipe Ports	
Port Size	Model Number
1/8 NPTF	862K77
1/4 NPTF	863K77
1/8 BSPP	D864K77
1/4 BSPP	D865K77

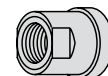

Pipe Ports	
Kit Description	Model Number
END PLATE (1)	857K77
Short Screw (2)	858K77
Long Screw (2)	859K77
Small O-Ring (for inlet or mating ports)	860K77
Large O-Ring (for outlet or mating ports)	861K77

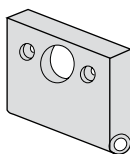

Tube Ports	
Port Size	Model Number
1/4	866K77
3/8	867K77
4 mm	868K77
6 mm	869K77
8 mm	870K77
10 mm	871K77

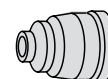

Modular Assemblies

Accessories: Clamp, Brackets, End Ports & Port Blocks

MD Series

Dimensions: inches (mm)

MD3™ Series

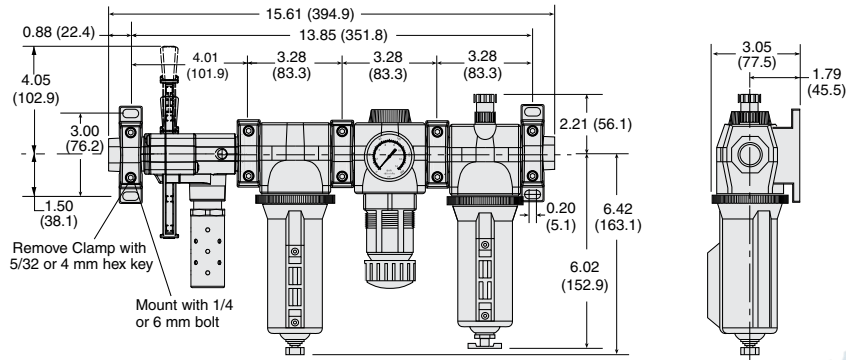

MD4™ Series

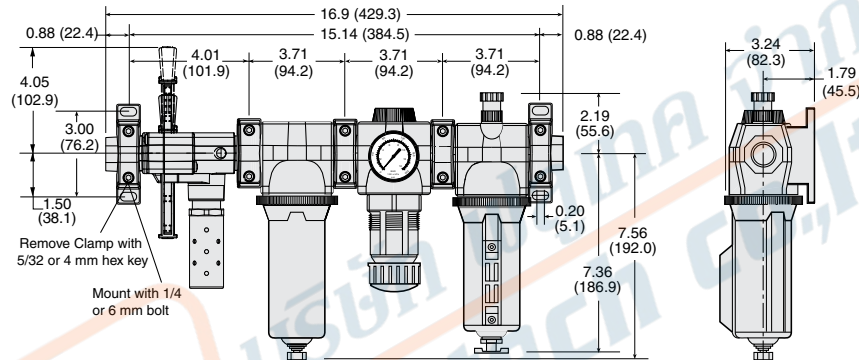

Mounting Brackets & Clamp for Module Connections

Two brackets are normally used to mount an FRL to a vertical surface. The mounting bracket attaches to the module connecting clamp (see above) with a single screw. Each bracket then employs two bolts (1/4" or 6mm) to connect the assembly to the mounting surface. Specially designed clamps provide a quick and easy assembly or disassembly of MD3™ modules. Two Allen-Head bolts quickly tighten or loosen the clamp using a 5/32 or 4mm hex key. The clamp contains a plate carrying two O-rings to provide positive sealing between modules.



Bracket, Screw, and Clamp



Module Connecting Clamp



Mounting Bracket

Mounting Brackets & Clamp for Module Connections

Description	Model Number
Bracket and Screw	R-A118-103
Module Connecting Clamp	R-A118-105
Bracket, Screw, and Clamp	R-A118-105M

Male and Female End Ports

Either male or female end ports can be attached to threaded inlet and outlet lines. This allows all modules of an FRL assembly to be removed easily and quickly without having to unthread the end modules. The end ports are attached to the modules with clamps (see at left). End ports can be included in an assembled FRL or ordered separately by the following model numbers:

Type	Port Size	Model Number		
		NPTF Threads	G Threads	
Female	1/4	R-118-100-2	R-118-100-2W	
	3/8	R-118-100-3	R-118-100-3W	
	1/2	R-118-100-4	R-118-100-4W	
Male	1/4	R-118-109-2F	R-118-109-2FW	
	3/8	R-118-109-3F	R-118-109-3FW	
	1/2	R-118-109-4F	R-118-109-4FW	
	3/4	R-118-109-6F	R-118-109-6FW	

Extra Port Blocks

An extra port block can be placed between modules to provide two auxiliary 1/4 NPTF ports. Its mounting position can be rotated to obtain the most convenient operating orientation. If only one auxiliary port is to be used, the unused port must be closed with a pipe plug. (The inlet and outlet are not threaded.)

Port Size	Model Number	
	NPTF Threads	G Threads
1/4	R-118-106-2	R-118-106-2W
3/8	R-118-106-3	R-118-106-3W
1/2	R-118-106-4	R-118-106-4W



บริษัท ฟลูเทค จำกัด
FLU-TECH CO.,LTD

845/3-4 หมู่ 3 ถ.เทพารักษ์ ต.เทพารักษ์ อ.เมือง จ.สมุทรปราการ 10270
845/3-4 Thepharak RD., T.Thepharak, A.Muang, Samutprakarn 10270 THAILAND
Tel. 0 2384 6060, Fax 0 2384 5701, Email : sales@flutech.co.th, www.flutech.co.th

Analog Pressure Gauges

Pressure Gauges (Center Back Mounting)	Type/Material	Port Size	Model Number		Pressure Range psig (bar)	Case Diameter inches (mm)
			Thread			
			NPT	G		
Standard Aluminum		1/8	5400A1002	D5400A1002	0-160 (0-11)	1.7 (43)
		1/4	5400A2010	D5400A2010	0-60 (0-4)	2.0 (51)
		1/4	5400A2011	D5400A2011	0-200 (0-14)	2.0 (51)
		1/4	5400A2012	D5400A2012	0-300 (0-20)	2.0 (51)
Liquid Filled Stainless Steel		1/4	5400A2014	D5400A2014	0-160 (0-11)	2.5 (64)
		1/4	5400A2015*	D5400A2015*	0-160 (0-11)	2.0 (51)

*Green shade between 40-70 psi (2.7-4.8 bar).

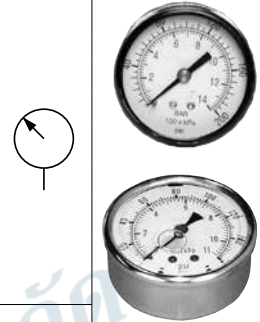

Differential Pressure Gauges

DIFFERENTIAL PRESSURE GAUGE TYPE/SERIES	Small Slide Gauge	Small Slide Gauge	Large Dual Face Gauge	Large Dual Face Gauge with Reed Switch (Normally Open)	Large Dual Face Gauge with Reed Switch (Normally Closed)
	R-A60F-28	R-K103-151	R-106-35	R-106-35E	R-106-35EC
FILTERS					
BANTAM	-	-	-	-	-
MINIATURE	-	-	-	-	-
MID-SIZE	-	-	-	-	-
MD3™	-	-	-	-	-
FULL-SIZE	-	-	-	-	-
MD4™	-	-	-	-	-
HIGH-CAPACITY	-	-	-	-	-
COALESCING FILTERS					
BANTAM	-	-	-	-	-
MINIATURE	-	-	-	-	-
MID-SIZE	-	-	-	-	-
FULL-SIZE	-	-	-	-	-
MD3™	-	-	-	-	-
MD4™	-	-	-	-	-
HIGH-CAPACITY	-	-	-	-	-
OIL VAPOR REMOVAL (ADSORBING) FILTERS					
MD3™	-	-	-	-	-
MD4™	-	-	-	-	-
CLEAN AIR PACKAGES					
MD3™	-	-	-	-	-
MD4™	-	-	-	-	-



External Automatic Drains

Pipe Size	Model Number*	
	Polycarbonate Bowl**	Metal Bowl
1/8	5057B1001	5058B1001
1/4*	5057B2001	5058B2001

*Use 1/4 size with FULL-SIZE, HIGH-CAPACITY, MD3™ & MD4™ filters.
Use kit 1076K77 to convert standard bowl to accept auto drain unit.
**Available for FULL-SIZE filters only. Polycarbonate bowl includes metal bowl guard.

Port Size	Dimensions inches (mm)			Weight lb (kg)
	A	B	C	
1/8, 1/4	3.5 (89)	4.2 (107)	8.3 (211)	2.6 (1.2)

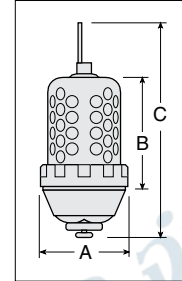

Electronically Controlled Drain

Pipe Size	Voltage	Model Number	
		NPTF Threads	G Threads
1/4	24 volts DC	R-DED-24V-2	R-DED-24V-2W
3/8	24 volts DC	R-DED-24V-3	R-DED-24V-3W
1/2	24 volts DC	R-DED-24V-4	R-DED-24V-4W
1/4	110-120 volts AC, 50/60 Hz	R-DED-115V-2	R-DED-115V-2W
3/8	110-120 volts AC, 50/60 Hz	R-DED-115V-3	R-DED-115V-3W
1/2	110-120 volts AC, 50/60 Hz	R-DED-115V-4	R-DED-115V-4W

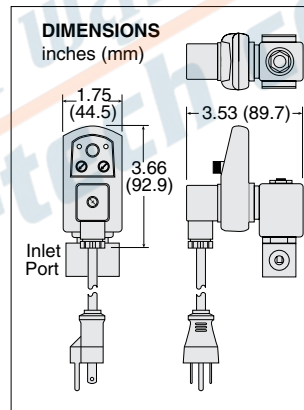

STANDARD SPECIFICATIONS (for electronically controlled drain):

Drain Time	Adjustable 0.5 to 10 seconds	Electrical Connection	DIN 43650A, ISO 440/6952
Drain Interval	0.5 to 45 minutes	Valve Type	2/2 direct acting, normally closed
Current Consumption	Maximum 4 ma	Valve Body	Forged brass; 3/16-inch (4.8 mm) orifice
Temperature	Ambient: 35° to 130°F (2° to 54°C)	Maximum Pressure	230 psig (15.8 bar)
	Media: 35° to 190°F (2° to 88°C)		

Silencers

Port Size	Thread Type	Model Number*		Avg. Cv	Dimensions inches (mm)		Weight lb (kg)
		NPT Threads	R/Rp Threads		Width	Length	
3/8	Male	5500A3003	D5500A3003	4.3	1.3 (32)	3.5 (88)	0.2 (0.1)
3/4	Male	5500A5013	D5500A5013	5.1	1.3 (32)	3.6 (92)	0.2 (0.1)
3/4	Male	5500A5003	D5500A5003	11.5	2.0 (51)	5.3 (135)	0.6 (0.3)

Flow Media: Filtered air.
Pressure Range: 0 to 290 psig (0 to 20 bar) maximum.



Replacements Filter Elements

FRL's Series

Category	Series	Bowl Type	Element Rating	Element Material	Model Number
Filters	Bantam & Miniature	Standard	5-µm	Polyethylene	933K77
			5-µm	Sintered Bronze	R-KA130-27E5
			20-µm	Sintered Bronze	R-KA130-27E4
			40-µm	Sintered Bronze	R-KA130-27E3
	MID-SIZE	Standard	5-µm	Polyethylene	936K77
	MD3™	Standard	5-µm	Polyethylene	R-A60F-03PE5
			5-µm	Sintered Bronze	R-A60F-03E5
			20-µm	Sintered Bronze	R-A60F-03E4
			40-µm	Sintered Bronze	R-A60F-03E3
	FULL-SIZE	Standard	5-µm	Polyethylene	939K77
			5-µm	Sintered Bronze	R-KA103-03E5
			20-µm	Sintered Bronze	R-KA103-03E4
			40-µm	Sintered Bronze	R-KA103-03E3
	MD4™	Standard	5-µm	Polyethylene	R-A115-106PE5
			5-µm	Sintered Bronze	R-A115-106E5
			20-µm	Sintered Bronze	R-A115-106E4
			40-µm	Polyethylene	R-A115-106PE3
	HIGH-CAPACITY Flow to 275 scfm	Standard	5-µm	Polyethylene	1010K77
			5-µm	Sintered Bronze	R-KA109-03E5
			20-µm	Sintered Bronze	R-KA109-03E4
40-µm			Sintered Bronze	R-KA109-03E3	
HIGH-CAPACITY Flow to 660 scfm	Standard	5-µm	Sintered Bronze	1656K77	
		40-µm	Sintered Bronze	R-A114-106E3	
HIGH-CAPACITY Flow to 1000 scfm	Standard	5-µm	Sintered Bronze	942K77	
		40-µm	Sintered Bronze	944K77	
Coalescing Filters	Bantam & Miniature	Standard	0.3-µm	Borosilicate-glass-fiber	945K77
			0.01-µm	Borosilicate-glass-fiber	R-A-10F-16E8
	MID-SIZE	Standard	0.3-µm	Borosilicate-glass-fiber	R-A60F-29
			0.3-µm	Borosilicate-glass-fiber	R-A60F-32
		Extended	0.01-µm	Borosilicate-glass-fiber	R-A60F-29E8
			0.01-µm	Borosilicate-glass-fiber	R-A60F-32E8
	MD3™	Polycarbonate	0.3-µm	Borosilicate-glass-fiber	R-A60F-23
		Metal	0.3-µm	Borosilicate-glass-fiber	R-A60F-29
		Extended Metal	0.3-µm	Borosilicate-glass-fiber	R-A60F-32
		Polycarbonate	0.01-µm	Borosilicate-glass-fiber	R-A60F-23E8
		Metal	0.01-µm	Borosilicate-glass-fiber	R-A60F-29E8
		Extended Metal	0.01-µm	Borosilicate-glass-fiber	R-A60F-32E8
	FULL-SIZE	Standard	0.3-µm	Borosilicate-glass-fiber	947K77
			0.3-µm	Borosilicate-glass-fiber	R-A103-160L
		Extended	0.01-µm	Borosilicate-glass-fiber	948K77
			0.01-µm	Borosilicate-glass-fiber	R-A103-160LE8
	MD4™	Standard	0.3-µm	Borosilicate-glass-fiber	R-A115-117
			0.3-µm	Borosilicate-glass-fiber	R-A115-118
		Extended	0.01-µm	Borosilicate-glass-fiber	R-A115-117E8
			0.01-µm	Borosilicate-glass-fiber	R-A115-118E8
	HIGH-CAPACITY Flow to 220 scfm	Standard	0.3-µm	Borosilicate-glass-fiber	949K77
			0.01-µm	Borosilicate-glass-fiber	R-A109-106E8
	HIGH-CAPACITY Flow to 295 & 450 scfm	Standard	0.3-µm	Borosilicate-glass-fiber	R-A114-112
			0.3-µm	Borosilicate-glass-fiber	R-A114-113
		Extended	0.01-µm	Borosilicate-glass-fiber	R-A114-112E8
			0.01-µm	Borosilicate-glass-fiber	R-A114-113E8
	HIGH-CAPACITY Flow to 465 scfm	Standard	0.3-µm	Borosilicate-glass-fiber	952K77
			0.3-µm	Borosilicate-glass-fiber	953K77
Extended		0.01-µm	Borosilicate-glass-fiber	R-A106-24E8	
		0.01-µm	Borosilicate-glass-fiber	R-A106-24LE8	
HIGH-CAPACITY Flow to 840 scfm	Extended	0.3-µm	Borosilicate-glass-fiber	953K77	
		0.01-µm	Borosilicate-glass-fiber	R-A106-24E8	
Oil Vapor Removal Filters	MD3™	Standard	–	Borosilicate-glass-fiber	R-A60F-29E9
		Extended	–	Borosilicate-glass-fiber	R-A60F-32E9
	MD4™	Standard	–	Borosilicate-glass-fiber	R-A115-117E9
		Extended	–	Borosilicate-glass-fiber	R-A115-118E9
Silencers Reclassifiers	Port Size 1/2	Standard	20-µm	Sintered Bronze	940K77
	Port Size 3/4, 1		100-µm	Sintered Bronze	981K77