



PRODUCT INFORMATION

FILTER AND REGULATOR

COMBINATION UNITS



ROSS CONTROLS

In-line Filter and Regulator Combinations

MINIATURE Series

Port Sizes: 1/8 & 1/4 – Flow to 19 scfm

FILTER and PISTON type REGULATOR					
Port Size	Port Threads	Automatic Drain		Manual Drain	
		Polycarbonate Bowl	Metal Bowl	Polycarbonate Bowl	Metal Bowl
		Model Number	Model Number	Model Number	Model Number
1/8	NPTF	5321C1027	5322C1024	5321C1026	5322C1025
	G	C5321C1027	C5322C1024	C5321C1026	C5322C1025
1/4	NPTF	5321C2027	5322C2024	5321C2026	5322C2025
	G	C5321C2027	C5322C2024	C5321C2026	C5322C2025



FILTER and DIAPHRAGM type REGULATOR					
Port Size	Port Threads	Automatic Drain		Manual Drain	
		Polycarbonate Bowl	Metal Bowl	Polycarbonate Bowl	Metal Bowl
		Model Number	Model Number	Model Number	Model Number
1/8	NPTF	5321C1037	5322C1034	5321C1036	5322C1035
	G	C5321C1037	C5322C1034	C5321C1036	C5322C1035
1/4	NPTF	5321C2037	5322C2034	5321C2036	5322C2035
	G	C5321C2037	C5322C2034	C5321C2036	C5322C2035

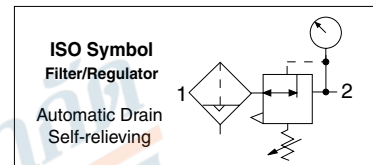

Port Size	Bowl Type	Bowl Capacity	Dimensions inches (mm)				Weight † lb (kg)
			A	B	C	Depth †	
1/8, 1/4	Polycarbonate	2-oz (60-ml)	4.4 (111)	3.6 (90)	0.7 (17)	1.6 (41)	0.77 (0.34)
	Aluminum	2-oz (60-ml)	4.4 (111)	4.3 (109)	0.7 (17)	1.6 (41)	0.79 (0.36)

† Less gauge.

REPLACEMENT FILTER ELEMENTS		
Element Rating	Element Material	Model Number
5-µm - Standard	Polyethylene	933K77
5-µm - Optional	Sintered Bronze	R-KA130-27E5
20-µm - Optional	Sintered Bronze	R-KA130-27E4
40-µm - Optional	Sintered Bronze	R-KA130-27E3

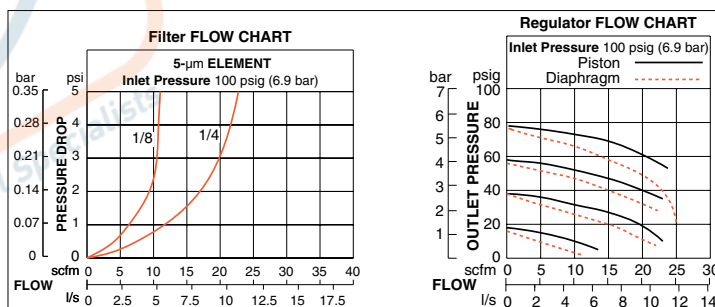
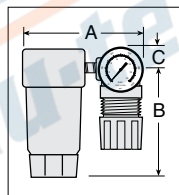

Pressure Gauge included.
Accessories ordered separately, refer to page G6.3-4.

STANDARD SPECIFICATIONS (for units on this page):

Construction Design	Filter – Fiber Regulator – Piston	Outlet Pressure	Adjustable up to 100 psig (7 bar).
Temperature	Ambient/Media: Polycarbonate Bowl: 40° to 125°F (4° to 52°C) Metal Bowl: 40° to 175°F (4° to 80°C)	Pressure Gauge	0 to 160 psig (0 to 11 bar); 1/8 NPT gauge ports front and rear
Fluid Media	Compressed air	Oil Adjustment	Internal; tamper-resistant
Operating Pressure	Automatic Drain Models Polycarbonate Bowl: 15 to 150 psig (1 to 10 bar) Metal Bowl: 15 to 200 psig (1 to 14 bar)	Panel Mounting	1-3/16 inch (30 mm) hole required
	Manual Drain Models Polycarbonate Bowl: 0 to 150 psig (0 to 10 bar) Metal Bowl: 0 to 200 psig (0 to 14 bar)	Construction Material	Filter Element: 5-micron rated polyethylene Heads: Aluminum Bowl: Polycarbonate or Aluminum Regulator Dome and Knob: Acetal Seals: Nitrile



บริษัท ฟลูเทค จำกัด
FLU-TECH CO.,LTD

845/3-4 หมู่ 3 ถ.เทพารักษ์ ต.เทพารักษ์ อ.เมือง จ.สมุทรปราการ 10270
845/3-4 Thepharak RD., T.Thepharak, A.Muang, Samutprakarn 10270 THAILAND
Tel. 0 2384 6060, Fax 0 2384 5701, Email : sales@flutech.co.th, www.flutech.co.th

G5

G

Modular Filter and Regulator Combinations

MID-SIZE Series

Port Sizes: 1/4, 3/8 & 1/2 – Flow to 100 scfm

Port Size	Port Threads	Automatic Drain		Manual Drain	
		Polycarbonate Bowl	Metal Bowl	Polycarbonate Bowl	Metal Bowl
		Model Number	Model Number	Model Number	Model Number
1/4	NPTF	5M11B2110	5M11B2210	5M11B2310	5M11B2410
	G	C5M11B2110	C5M11B2210	C5M11B2310	C5M11B2410
3/8	NPTF	5M11B3110	5M11B3210	5M11B3310	5M11B3410
	G	C5M11B3110	C5M11B3210	C5M11B3310	C5M11B3410
1/2	NPTF	5M11B4110	5M11B4210	5M11B4310	5M11B4410
	G	C5M11B4110	C5M11B4210	C5M11B4310	C5M11B4410



Port Size	Bowl Type	Bowl Capacity	Dimensions inches (mm)				Weight † lb (kg)
			A	B	C	Depth †	
1/4, 3/8, 1/2	Polycarbonate	4-oz (120-ml)	5.4 (137)	6.2 (157)	1.3 (33)	2.8 (71)	2.20 (1.00)
	Zinc	4-oz (120-ml)	5.4 (137)	6.3 (160)	1.3 (33)	2.8 (71)	2.57 (1.17)

† Less gauge.

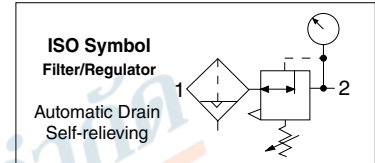

REPLACEMENT FILTER ELEMENTS		
Element Rating	Element Material	Model Number
5-µm - Standard	Polyethylene	936K77
5-µm - Optional	Sintered Bronze	R-KA60F-03E5
20-µm - Optional	Sintered Bronze	R-KA60F-03E4
40-µm - Optional	Sintered Bronze	R-KA60F-03E3

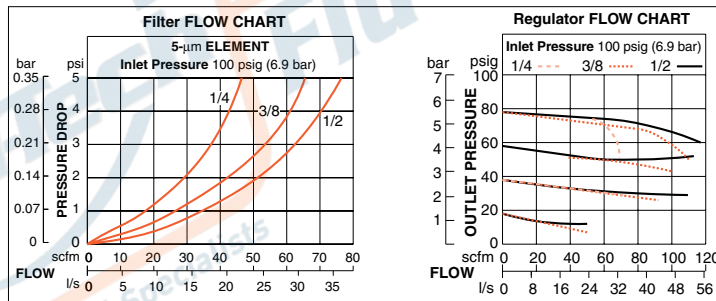
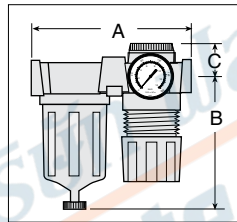

Pressure Gauge included.
Includes 2 female port blocks.
Accessories ordered separately, refer to page G6.3-4.

STANDARD SPECIFICATIONS (for units on this page):

Construction Design	Filter – Fiber Regulator – Piston	Pressure Gauge	0 to 200 psig (0 to 14 bar); 1/4 NPT gauge ports front and rear
Temperature	Ambient/Media: Polycarbonate Bowl: 40° to 125°F (4° to 52°C) Metal Bowl: 40° to 175°F (4° to 80°C)	Pressure Adjustment	Locking Key: Removable
Fluid Media	Compressed air	Oil Adjustment	External; tamper-resistant
Operating Pressure	Automatic Drain Models Polycarbonate Bowl: 15 to 150 psig (1 to 10 bar) Metal Bowl: 15 to 200 psig (1 to 14 bar)	Panel Mounting	1-9/16 inch (40 mm) hole required
	Manual Drain Models Polycarbonate Bowl: 0 to 150 psig (0 to 10 bar) Metal Bowl: 0 to 200 psig (0 to 14 bar)	Construction Material	Filter Element: 5-micron rated polyethylene
Outlet Pressure	Adjustable up to 100 psig (7 bar).		Heads: Zinc
			Bowl: Polycarbonate bowl with zinc shatterguard, or zinc bowl
			Regulator Dome: Acetal; Metal optional, consult ROSS
		Regulator Knob: Acetal	
		Sight Dome: Clear Nylon	
		Seals: Nitrile	



บริษัท ฟลูเทค จำกัด
FLU-TECH CO.,LTD

845/3-4 หมู่ 3 ถ.เทพารักษ์ ต.เทพารักษ์ อ.เมือง จ.สมุทรปราการ 10270

845/3-4 Thepharak RD., T.Thepharak, A.Muang, Samutprakarn 10270 THAILAND
 Tel. 0 2384 6060, Fax 0 2384 5701, Email : sales@flutech.co.th, www.flutech.co.th

G5

G

Modular Filter and Regulator Combinations

FULL-SIZE Series

Port Sizes: 1/4, 3/8, 1/2 & 3/4 – Flow to 138 scfm

Port Size	Port Threads	Automatic Drain		Manual Drain	
		Polycarbonate Bowl	Metal Bowl	Polycarbonate Bowl	Metal Bowl
		Model Number	Model Number	Model Number	Model Number
With THREADED PORTS					
1/4	NPTF	5F11B2120	5F11B2220	5F11B2320	5F11B2420
	G	C5F11B2120	C5F11B2220	C5F11B2320	C5F11B2420
3/8	NPTF	5F11B3120	5F11B3220	5F11B3320	5F11B3420
	G	C5F11B3120	C5F11B3220	C5F11B3320	C5F11B3420
1/2	NPTF	5F11B4120	5F11B4220	5F11B4320	5F11B4420
	G	C5F11B4120	C5F11B4220	C5F11B4320	C5F11B4420
3/4	NPTF	5F11B5120	5F11B5220	5F11B5320	5F11B5420
	G	C5F11B5120	C5F11B5220	C5F11B5320	C5F11B5420
With PIPE NIPPLES					
1/4	NPTF	5F00B2120	5F00B2220	5F00B2320	5F00B2420
	G	C5F00B2120	C5F00B2220	C5F00B2320	C5F00B2420
3/8	NPTF	5F00B3120	5F00B3220	5F00B3320	5F00B3420
	G	C5F00B3120	C5F00B3220	C5F00B3320	C5F00B3420
1/2	NPTF	5F00B4120	5F00B4220	5F00B4320	5F00B4420
	G	C5F00B4120	C5F00B4220	C5F00B4320	C5F00B4420
3/4	NPTF	5F00B5120	5F00B5220	5F00B5320	5F00B5420
	G	C5F00B5120	C5F00B5220	C5F00B5320	C5F00B5420

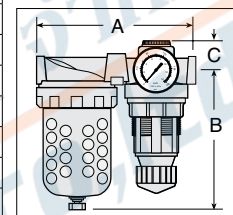
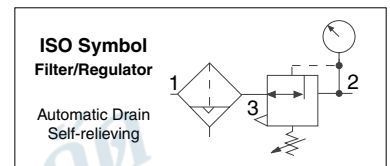

Port Size	Bowl Type	Bowl Capacity	Dimensions inches (mm)				Weight † lb (kg)
			A	B	C	Depth †	
1/4, 3/8, 1/2, 3/4	Polycarbonate	8-oz (240-ml)	7.0 (178)	5.8 (147)	1.3 (33)	2.8 (71)	4.09 (1.86)
	Zinc	8-oz (240-ml)	7.0 (178)	6.4 (163)	1.3 (33)	2.8 (71)	5.06 (2.30)

† Less gauge.

REPLACEMENT FILTER ELEMENTS		
Element Rating	Element Material	Model Number
5-µm - Standard	Polyethylene	939K77
5-µm - Optional	Sintered Bronze	R-KA103-03E5
20-µm - Optional	Sintered Bronze	R-KA103-03E4
40-µm - Optional	Sintered Bronze	R-KA103-03E3

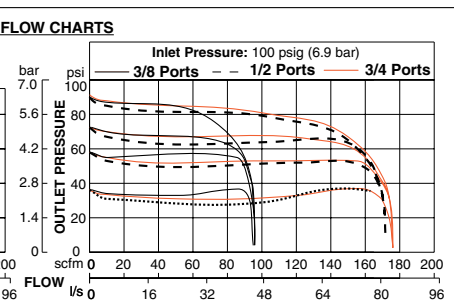
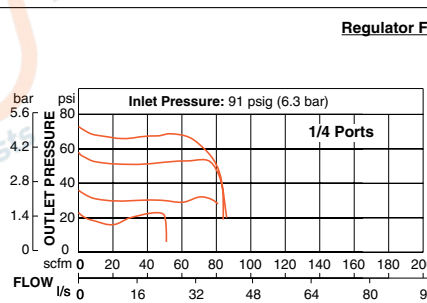
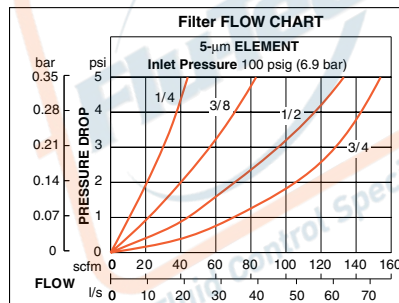

Pressure Gauge included. Units with Threaded Ports Include 2 female port blocks.
Options: External Automatic Drain, refer to page G6.7. Accessories ordered separately, refer to page G6.3-4.

STANDARD SPECIFICATIONS (for units on this page):

Construction Design	Filter – Fiber Regulator – Piston	Pressure Gauge	0 to 200 psig (0 to 14 bar); 1/4 NPT gauge ports front and rear
Temperature	Ambient/Media: Polycarbonate Bowl: 40° to 125°F (4° to 52°C) Metal Bowl: 40° to 175°F (4° to 80°C)	Pressure Adjustment	Locking Key: Removable
Fluid Media	Compressed air	Oil Adjustment	External; tamper-resistant
Operating Pressure	Automatic Drain Models Polycarbonate Bowl: 15 to 150 psig (1 to 10 bar) Metal Bowl: 15 to 200 psig (1 to 14 bar)	Construction Material	Filter Element: 5-micron rated polyethylene
	Manual Drain Models Polycarbonate Bowl: 0 to 150 psig (0 to 10 bar) Metal Bowl: 0 to 200 psig (0 to 14 bar)		Heads: Zinc Bowl: Polycarbonate bowl with steel shatterguard, or zinc bowl with clear nylon sight glass
Outlet Pressure	Adjustable up to 125 psig (9 bar).		Bowl Rings: Aluminum Regulator Dome: Nylon Regulator Knob: Acetal Sight Dome: Clear Nylon Seals: Nitrile



บริษัท ฟลูเทค จำกัด
FLU-TECH CO.,LTD

845/3-4 หมู่ 3 ถ.เทพารักษ์ ต.เทพารักษ์ อ.เมือง จ.สมุทรปราการ 10270

845/3-4 Thepharak RD., T.Thepharak, A.Muang, Samutprakarn 10270 THAILAND
Tel. 0 2384 6060, Fax 0 2384 5701, Email : sales@flutech.co.th, www.flutech.co.th

G5

G

In-line Filter and Regulator Combinations

HIGH-CAPACITY Series

Port Sizes: 3/4 & 1 – Flow to 270 scfm

Port Size	Port Threads	Automatic Drain		Manual Drain	
		Polycarbonate Bowl	Metal Bowl	Polycarbonate Bowl	Metal Bowl
		Model Number	Model Number	Model Number	Model Number
3/4	NPTF	5H00C5110	5H00C5210	5H00C5310	5H00C5410
	G	C5H00C5110	C5H00C5210	C5H00C5310	C5H00C5410
1	NPTF	5H00C6110	5H00C6210	5H00C6310	5H00C6410
	G	C5H00C6110	C5H00C6210	C5H00C6310	C5H00C6410



Port Size	Bowl Type	Bowl Capacity	Dimensions inches (mm)				Weight † lb (kg)
			A	B	C	Depth †	
3/4, 1	Polycarbonate	16-oz (480-ml)	9.1 (231)	8.0 (203)	2.4 (62)	4.3 (108)	4.53 (2.05)
	Zinc	16-oz (480-ml)	9.1 (231)	8.3 (210)	2.1 (54)	4.3 (108)	5.95 (2.70)

† Less gauge.

REPLACEMENT FILTER ELEMENTS

Element Rating	Element Material	Model Number
5-µm - Standard	Polyethylene	1010K77
5-µm - Optional	Sintered Bronze	R-KA109-03E5
20-µm - Optional	Sintered Bronze	R-KA109-03E4
40-µm - Optional	Sintered Bronze	R-KA109-03E3

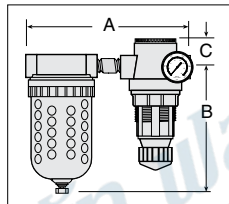

ISO Symbol Filter/Regulator

Automatic Drain
Self-relieving

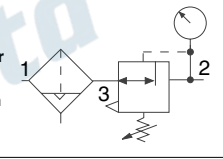

Filter FLOW CHART

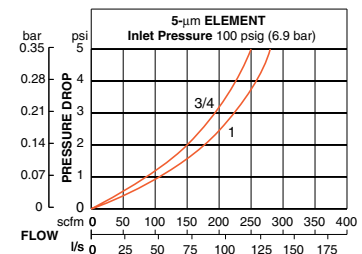

Regulator FLOW CHARTS

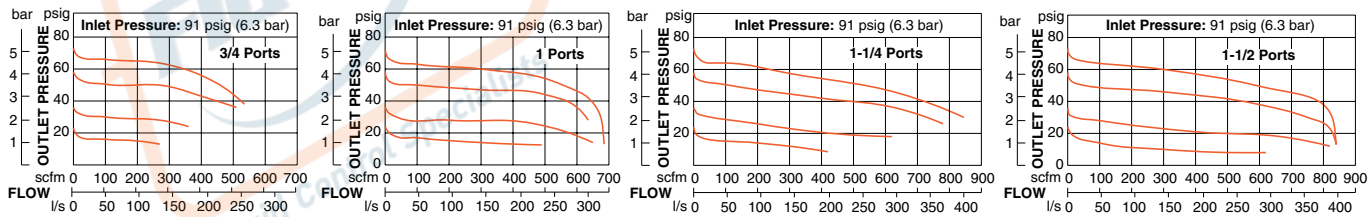

G5

G

Pressure Gauge included.

Options: External Automatic Drain, Electronic Drain, refer to page G6.7.

Accessories ordered separately, refer to page G6.3-4.

STANDARD SPECIFICATIONS (for units on this page):

Construction Design	Filter – Fiber Regulator – Piston	Outlet Pressure	Adjustable up to 100 psig (7 bar).
Temperature	Ambient/Media:	Pressure Gauge	0 to 200 psig (0 to 14 bar); 1/4 NPT gauge ports front and rear
	Polycarbonate Bowl: 40° to 125°F (4° to 52°C) Metal Bowl: 40° to 175°F (4° to 80°C)	Pressure Adjustment	Locking Key: Removable
Fluid Media	Compressed air	Oil Adjustment	External; tamper-resistant
Operating Pressure	Automatic Drain Models	Construction Material	Filter Element: 5-micron rated polyethylene
	Polycarbonate Bowl: 15 to 150 psig (1 to 10 bar) Metal Bowl: 15 to 200 psig (1 to 14 bar)		Heads: Aluminum
	Manual Drain Models		Bowl: Polycarbonate bowl with steel shatterguard, or zinc bowl with clear nylon sight glass
	Polycarbonate Bowl: 0 to 150 psig (0 to 10 bar) Metal Bowl: 0 to 200 psig (0 to 14 bar)		Bowl Rings: Aluminum
			Seals: Nitrile



บริษัท ฟลูเทค จำกัด
FLU-TECH CO.,LTD

845/3-4 หมู่ 3 ถ.เทพารักษ์ ต.เทพารักษ์ อ.เมือง จ.สมุทรปราการ 10270

845/3-4 Thepharak RD., T.Thepharak, A.Muang, Samutprakarn 10270 THAILAND
Tel. 0 2384 6060, Fax 0 2384 5701, Email : sales@flutech.co.th, www.flutech.co.th

Mounting Screws for BANTAM Models

Usage Models	Kit Number
BANTAM	859K77

BANTAM models mounts with long screws that extend through end plates.

Mounting Brackets for Regulators and Integrated Filter/Regulators

Regulators and integrated filter/regulators can be mounted to a surface with a bracket that attaches to the regulator. Brackets and mounting panel nuts can be ordered separately or in a kit which includes both bracket and mounting panel nut.

Usage Models	Model Number			Dimensions inches (mm)					Panel Mounting Hole Diameter
	Kit	Bracket	Panel Nut	A	B	C	D	E	
MINIATURE	873K77	872K77	874K77	1.375 (35)	1.125 (29)	0.31 (8)	0.31 (8)	0.69 (17)	1.19 (30)
MID-SIZE	876K77	875K77	877K77	2.38 (60)	1.00 (25)	1.50 (38)	-	-	1.56 (40)
MD3™	R-A127-11	-	R-127-11	2.38 (60)	1.00 (25)	1.50 (38)	-	-	2.06 (52)
FULL-SIZE, MD4™	879K77	878K77	880K77						

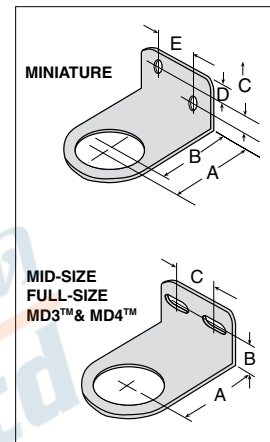

Modular Mounting Brackets for Filters, Regulators, Lubricators, FRL's, or Clean Air Packages

Two L-shaped metal brackets as shown at the right can be used for wall mounting of modular FRLs or Clean Air Packages. A single bracket can be used to mount individual filters or lubricators. Kits include two brackets and four screws for attaching the brackets to the modules.

Usage Models	Kit Number	Dimensions inches (mm)			
		A	B	C	D
MID-SIZE & FULL-SIZE	915K77	3.0 (76)	0.88 (22)	1.00 (25)	1.20 (31)

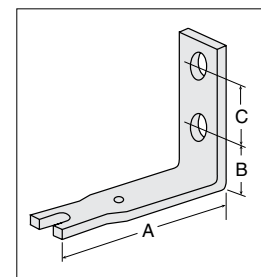

FRLs In-line Mounting Pipe Brackets

Two pipe brackets can be used for wall mounting of FRLs assemblies that use pipe nipples to join the components. The bracket kits listed below include two sets of brackets.

Nipple Size	Kit Number	Dimensions inches (mm)		
		A	B	C
1/4	887K77	2.72 (28)	0.50 (13)	1.00 (25)
3/8	888K77			
1/2	889K77			
3/4	890K77	3.69 (94)	1.13 (29)	1.25 (32)
1	891K77			

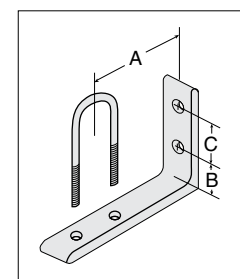

Bracket Assembly Kit for HIGH-RELIEF Pilot Operated Regulator

High-Relief Pilot Operated Regulator with 1/4- thru 1 1/4 inch ports can be mounted to a vertical surface using a bracket assembly kit.

Kit Number	R-A37-381
------------	-----------



MID-SIZE and FULL-SIZE Units

The modular designs of the MID-SIZE and FULL-SIZE series offer maximum flexibility in customizing FRLs assemblies. As shown at the right, connector kits are required to interconnect units. Various port kits (shown below) can be used to connect the assemblies to the inlet and outlet piping. Note that all FRLs components have threaded ports so that conventional pipe fittings may be used where desired.

Female Port Block

Used to connect to piping at inlet or outlet.

Port Size	Model Number	
	NPTF Threads	G Threads
1/4	897K77	D897K77
3/8	898K77	D898K77
1/2	899K77	D899K77
3/4	900K77	D900K77



Male Port Block

Used to connect modular to non-modular units.

Port Size	Model Number	
	NPTF Threads	G Threads
1/4	893K77	D893K77
3/8	894K77	D894K77
1/2	895K77	D895K77
3/4	896K77	D896K77



Connector Kit

Used to connect units to one another as well as to any of the ports shown on this page.

Kit Number 892K77

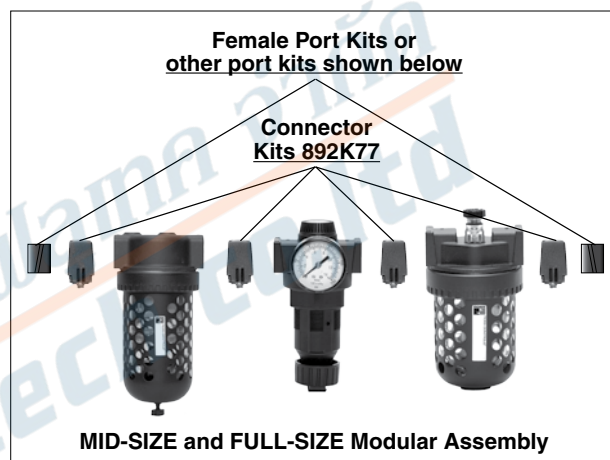

BANTAM Units

BANTAM modular units use end plates secured with screws to hold the pipe or tubing ports (see below), and also to serve as mounting brackets. Short screws are used to secure the end plates when a single BANTAM unit is used. If two or more units are combined, long screws extend through an end plate and thread into the next unit.

Screw kits required are as follows:

Single Unit: Two short screw kits.

Two-Unit Combination: One each short screw kit and long screw kit.

Three-Unit Combination: Two long screw kits.

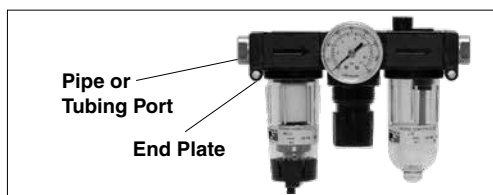

Pipe Ports	
Port Size	Model Number
1/8 NPTF	862K77
1/4 NPTF	863K77
1/8 BSPP	D864K77
1/4 BSPP	D865K77

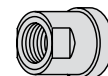

Pipe Ports	
Kit Description	Model Number
END PLATE (1)	857K77
Short Screw (2)	858K77
Long Screw (2)	859K77
Small O-Ring (for inlet or mating ports)	860K77
Large O-Ring (for outlet or mating ports)	861K77

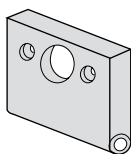

Tube Ports	
Port Size	Model Number
1/4	866K77
3/8	867K77
4 mm	868K77
6 mm	869K77
8 mm	870K77
10 mm	871K77

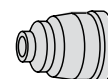

Modular Assemblies

Accessories: Clamp, Brackets, End Ports & Port Blocks

MD Series

Dimensions: inches (mm)

MD3™ Series

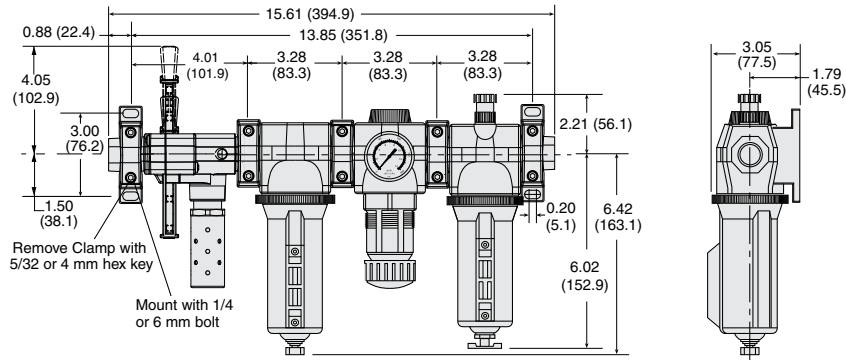

MD4™ Series

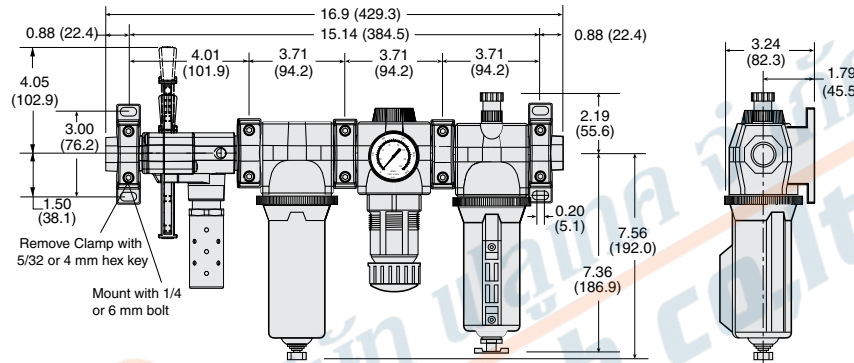

Mounting Brackets & Clamp for Module Connections

Two brackets are normally used to mount an FRL to a vertical surface. The mounting bracket attaches to the module connecting clamp (see above) with a single screw. Each bracket then employs two bolts (1/4" or 6mm) to connect the assembly to the mounting surface. Specially designed clamps provide a quick and easy assembly or disassembly of MD3™ modules. Two Allen-Head bolts quickly tighten or loosen the clamp using a 5/32 or 4mm hex key. The clamp contains a plate carrying two O-rings to provide positive sealing between modules.



Bracket, Screw, and Clamp



Module Connecting Clamp



Mounting Bracket

Mounting Brackets & Clamp for Module Connections

Description	Model Number
Bracket and Screw	R-A118-103
Module Connecting Clamp	R-A118-105
Bracket, Screw, and Clamp	R-A118-105M

Male and Female End Ports

Either male or female end ports can be attached to threaded inlet and outlet lines. This allows all modules of an FRL assembly to be removed easily and quickly without having to unthread the end modules. The end ports are attached to the modules with clamps (see at left). End ports can be included in an assembled FRL or ordered separately by the following model numbers:

Type	Port Size	Model Number		
		NPTF Threads	G Threads	
Female	1/4	R-118-100-2	R-118-100-2W	
	3/8	R-118-100-3	R-118-100-3W	
	1/2	R-118-100-4	R-118-100-4W	
	3/4	R-118-100-6	R-118-100-6W	
Male	1/4	R-118-109-2F	R-118-109-2FW	
	3/8	R-118-109-3F	R-118-109-3FW	
	1/2	R-118-109-4F	R-118-109-4FW	
	3/4	R-118-109-6F	R-118-109-6FW	

Extra Port Blocks

An extra port block can be placed between modules to provide two auxiliary 1/4 NPTF ports. Its mounting position can be rotated to obtain the most convenient operating orientation. If only one auxiliary port is to be used, the unused port must be closed with a pipe plug. (The inlet and outlet are not threaded.)

Port Size	Model Number	
	NPTF Threads	G Threads
1/4	R-118-106-2	R-118-106-2W
3/8	R-118-106-3	R-118-106-3W
1/2	R-118-106-4	R-118-106-4W



บริษัท ฟลูเทค จำกัด
FLU-TECH CO.,LTD

845/3-4 หมู่ 3 ถ.เทพารักษ์ ต.เทพารักษ์ อ.เมือง จ.สมุทรปราการ 10270

845/3-4 Thepharak RD., T.Thepharak, A.Muang, Samutprakarn 10270 THAILAND
Tel. 0 2384 6060, Fax 0 2384 5701, Email : sales@flutech.co.th, www.flutech.co.th

Analog Pressure Gauges

Pressure Gauges (Center Back Mounting)	Type/Material	Port Size	Model Number		Pressure Range psig (bar)	Case Diameter inches (mm)
			Thread			
			NPT	G		
Standard Aluminum		1/8	5400A1002	D5400A1002	0-160 (0-11)	1.7 (43)
		1/4	5400A2010	D5400A2010	0-60 (0-4)	2.0 (51)
		1/4	5400A2011	D5400A2011	0-200 (0-14)	2.0 (51)
		1/4	5400A2012	D5400A2012	0-300 (0-20)	2.0 (51)
Liquid Filled Stainless Steel		1/4	5400A2014	D5400A2014	0-160 (0-11)	2.5 (64)
		1/4	5400A2015*	D5400A2015*	0-160 (0-11)	2.0 (51)

*Green shade between 40-70 psi (2.7-4.8 bar).

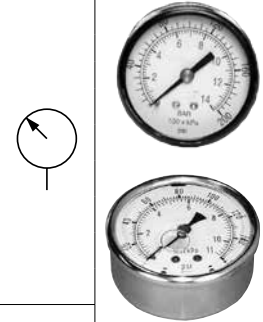

Differential Pressure Gauges

DIFFERENTIAL PRESSURE GAUGE TYPE/SERIES	Small Slide Gauge	Small Slide Gauge	Large Dual Face Gauge	Large Dual Face Gauge with Reed Switch (Normally Open)	Large Dual Face Gauge with Reed Switch (Normally Closed)
	R-A60F-28	R-K103-151	R-106-35	R-106-35E	R-106-35EC
FILTERS					
BANTAM	-	-	-	-	-
MINIATURE	-	-	-	-	-
MID-SIZE	-	-	-	-	-
MD3™		-	-	-	-
FULL-SIZE	-	-	-	-	-
MD4™	-				
HIGH-CAPACITY	-	-	-	-	-
COALESCING FILTERS					
BANTAM	-	-	-	-	-
MINIATURE	-	-	-	-	-
MID-SIZE		-	-	-	-
FULL-SIZE	-				
MD3™		-	-	-	-
MD4™	-				
HIGH-CAPACITY	-				
OIL VAPOR REMOVAL (ADSORBING) FILTERS					
MD3™	-	-	-	-	-
MD4™	-	-	-	-	-
CLEAN AIR PACKAGES					
MD3™		-	-	-	-
MD4™	-				



External Automatic Drains

Pipe Size	Model Number*	
	Polycarbonate Bowl**	Metal Bowl
1/8	5057B1001	5058B1001
1/4*	5057B2001	5058B2001

*Use 1/4 size with FULL-SIZE, HIGH-CAPACITY, MD3™ & MD4™ filters.
Use kit 1076K77 to convert standard bowl to accept auto drain unit.
**Available for FULL-SIZE filters only. Polycarbonate bowl includes metal bowl guard.

Port Size	Dimensions inches (mm)			Weight lb (kg)
	A	B	C	
1/8, 1/4	3.5 (89)	4.2 (107)	8.3 (211)	2.6 (1.2)

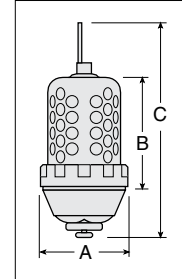

Electronically Controlled Drain

Pipe Size	Voltage	Model Number	
		NPTF Threads	G Threads
1/4	24 volts DC	R-DED-24V-2	R-DED-24V-2W
3/8	24 volts DC	R-DED-24V-3	R-DED-24V-3W
1/2	24 volts DC	R-DED-24V-4	R-DED-24V-4W
1/4	110-120 volts AC, 50/60 Hz	R-DED-115V-2	R-DED-115V-2W
3/8	110-120 volts AC, 50/60 Hz	R-DED-115V-3	R-DED-115V-3W
1/2	110-120 volts AC, 50/60 Hz	R-DED-115V-4	R-DED-115V-4W

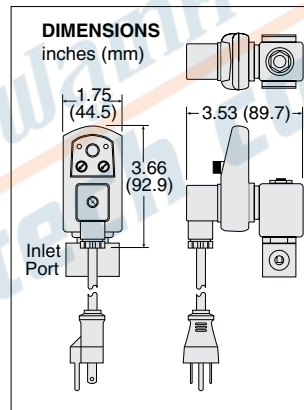

STANDARD SPECIFICATIONS (for electronically controlled drain):

Drain Time	Adjustable 0.5 to 10 seconds	Electrical Connection	DIN 43650A, ISO 440/6952
Drain Interval	0.5 to 45 minutes	Valve Type	2/2 direct acting, normally closed
Current Consumption	Maximum 4 ma	Valve Body	Forged brass; 3/16-inch (4.8 mm) orifice
Temperature	Ambient: 35° to 130°F (2° to 54°C)	Maximum Pressure	230 psig (15.8 bar)
	Media: 35° to 190°F (2° to 88°C)		

Silencers

Port Size	Thread Type	Model Number*		Avg. Cv	Dimensions inches (mm)		Weight lb (kg)
		NPT Threads	R/Rp Threads		Width	Length	
3/8	Male	5500A3003	D5500A3003	4.3	1.3 (32)	3.5 (88)	0.2 (0.1)
3/4	Male	5500A5013	D5500A5013	5.1	1.3 (32)	3.6 (92)	0.2 (0.1)
3/4	Male	5500A5003	D5500A5003	11.5	2.0 (51)	5.3 (135)	0.6 (0.3)

Flow Media: Filtered air.
Pressure Range: 0 to 290 psig (0 to 20 bar) maximum.

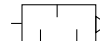

Replacements Filter Elements

FRL's Series

Category	Series	Bowl Type	Element Rating	Element Material	Model Number	
Filters	Bantam & Miniature	Standard	5-µm	Polyethylene	933K77	
			5-µm	Sintered Bronze	R-KA130-27E5	
			20-µm	Sintered Bronze	R-KA130-27E4	
			40-µm	Sintered Bronze	R-KA130-27E3	
	MID-SIZE	Standard	5-µm	Polyethylene	936K77	
	MD3™	Standard	5-µm	Polyethylene	R-A60F-03PE5	
			5-µm	Sintered Bronze	R-A60F-03E5	
			20-µm	Sintered Bronze	R-A60F-03E4	
			40-µm	Sintered Bronze	R-A60F-03E3	
	FULL-SIZE	Standard	5-µm	Polyethylene	939K77	
			5-µm	Sintered Bronze	R-KA103-03E5	
			20-µm	Sintered Bronze	R-KA103-03E4	
			40-µm	Sintered Bronze	R-KA103-03E3	
	MD4™	Standard	5-µm	Polyethylene	R-A115-106PE5	
			5-µm	Sintered Bronze	R-A115-106E5	
			20-µm	Sintered Bronze	R-A115-106E4	
			40-µm	Polyethylene	R-A115-106PE3	
	HIGH-CAPACITY Flow to 275 scfm	Standard	5-µm	Polyethylene	1010K77	
			5-µm	Sintered Bronze	R-KA109-03E5	
			20-µm	Sintered Bronze	R-KA109-03E4	
40-µm			Sintered Bronze	R-KA109-03E3		
HIGH-CAPACITY Flow to 660 scfm	Standard	5-µm	Sintered Bronze	1656K77		
		40-µm	Sintered Bronze	R-A114-106E3		
HIGH-CAPACITY Flow to 1000 scfm	Standard	5-µm	Sintered Bronze	942K77		
		40-µm	Sintered Bronze	944K77		
Coalescing Filters	Bantam & Miniature	Standard	0.3-µm	Borosilicate-glass-fiber	945K77	
			0.01-µm	Borosilicate-glass-fiber	R-A-10F-16E8	
	MID-SIZE	Standard	0.3-µm	Borosilicate-glass-fiber	R-A60F-29	
			Extended	0.3-µm	Borosilicate-glass-fiber	R-A60F-32
			Standard	0.01-µm	Borosilicate-glass-fiber	R-A60F-29E8
			Extended	0.01-µm	Borosilicate-glass-fiber	R-A60F-32E8
	MD3™	Standard	Polycarbonate	0.3-µm	Borosilicate-glass-fiber	R-A60F-23
			Metal	0.3-µm	Borosilicate-glass-fiber	R-A60F-29
			Extended Metal	0.3-µm	Borosilicate-glass-fiber	R-A60F-32
			Polycarbonate	0.01-µm	Borosilicate-glass-fiber	R-A60F-23E8
			Metal	0.01-µm	Borosilicate-glass-fiber	R-A60F-29E8
			Extended Metal	0.01-µm	Borosilicate-glass-fiber	R-A60F-32E8
	FULL-SIZE	Standard	Standard	0.3-µm	Borosilicate-glass-fiber	947K77
			Extended	0.3-µm	Borosilicate-glass-fiber	R-A103-160L
			Standard	0.01-µm	Borosilicate-glass-fiber	948K77
			Extended	0.01-µm	Borosilicate-glass-fiber	R-A103-160LE8
	MD4™	Standard	Standard	0.3-µm	Borosilicate-glass-fiber	R-A115-117
			Extended	0.3-µm	Borosilicate-glass-fiber	R-A115-118
			Standard	0.01-µm	Borosilicate-glass-fiber	R-A115-117E8
			Extended	0.01-µm	Borosilicate-glass-fiber	R-A115-118E8
	HIGH-CAPACITY Flow to 220 scfm	Standard	0.3-µm	Borosilicate-glass-fiber	949K77	
			0.01-µm	Borosilicate-glass-fiber	R-A109-106E8	
			Standard	0.3-µm	Borosilicate-glass-fiber	R-A114-112
			Extended	0.3-µm	Borosilicate-glass-fiber	R-A114-113
	HIGH-CAPACITY Flow to 295 & 450 scfm	Standard	Standard	0.01-µm	Borosilicate-glass-fiber	R-A114-112E8
			Extended	0.01-µm	Borosilicate-glass-fiber	R-A114-113E8
			Standard	0.3-µm	Borosilicate-glass-fiber	952K77
			Extended	0.3-µm	Borosilicate-glass-fiber	953K77
HIGH-CAPACITY Flow to 465 scfm	Standard	Standard	0.01-µm	Borosilicate-glass-fiber	R-A106-24E8	
		Extended	0.01-µm	Borosilicate-glass-fiber	R-A106-24LE8	
		Standard	0.3-µm	Borosilicate-glass-fiber	953K77	
HIGH-CAPACITY Flow to 840 scfm	Extended	0.3-µm	Borosilicate-glass-fiber	953K77		
		0.01-µm	Borosilicate-glass-fiber	R-A106-24E8		
Oil Vapor Removal Filters	MD3™	Standard	–	Borosilicate-glass-fiber	R-A60F-29E9	
		Extended	–	Borosilicate-glass-fiber	R-A60F-32E9	
	MD4™	Standard	–	Borosilicate-glass-fiber	R-A115-117E9	
		Extended	–	Borosilicate-glass-fiber	R-A115-118E9	
Silencers Reclassifiers	Port Size 1/2	Standard	20-µm	Sintered Bronze	940K77	
	Port Size 3/4, 1		100-µm	Sintered Bronze	981K77	

G