



PRODUCT INFORMATION

FILTER AND LUBRICATOR

COMBINATION UNITS



ROSS CONTROLS

In-line Filter and Lubricator Combinations

MINIATURE Series

Port Sizes: 1/8 & 1/4 – Flow to 19 scfm

Port Size	Port Threads	Automatic Drain		Manual Drain	
		Polycarbonate Bowl	Metal Bowl	Polycarbonate Bowl	Metal Bowl
		Model Number	Model Number	Model Number	Model Number
With Fill Port Lubricator					
1/8	NPTF	5311C1012	5312C1012	5311C1011	5312C1011
	G	C5311C1012	C5312C1012	C5311C1011	C5312C1011
1/4	NPTF	5311C2012	5312C2012	5311C2011	5312C2011
	G	C5311C2012	C5312C2012	C5311C2011	C5312C2011
With Quick-Fill Cap Lubricator					
1/8	NPTF	5311C1112	5312C1112	5311C1111	5312C1111
	G	C5311C1112	C5312C1112	C5311C1111	C5312C1111
1/4	NPTF	5311C2112	5312C2112	5311C2111	5312C2111
	G	C5311C2112	C5312C2112	C5311C2111	C5312C2111

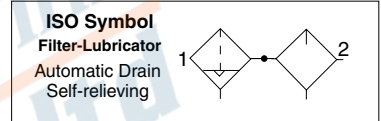

Port Size	Bowl Type	Bowl Capacity	Dimensions inches (mm)				Weight † lb (kg)
			A	B	C	Depth †	
1/8, 1/4	Polycarbonate	2-oz (60-ml)	3.4 (86)	3.6 (90)	0.7 (17)	1.6 (41)	0.59 (0.27)
	Metal	2-oz (60-ml)	3.4 (86)	4.3 (109)	0.7 (17)	1.6 (41)	0.59 (0.27)

† Less gauge.

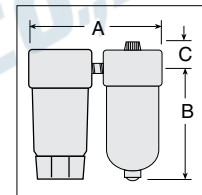

REPLACEMENT FILTER ELEMENTS

Element Rating	Element Material	Model Number
5-µm - Standard	Polyethylene	933K77
5-µm - Optional	Sintered Bronze	R-KA130-27E5
20-µm - Optional	Sintered Bronze	R-KA130-27E4
40-µm - Optional	Sintered Bronze	R-KA130-27E3

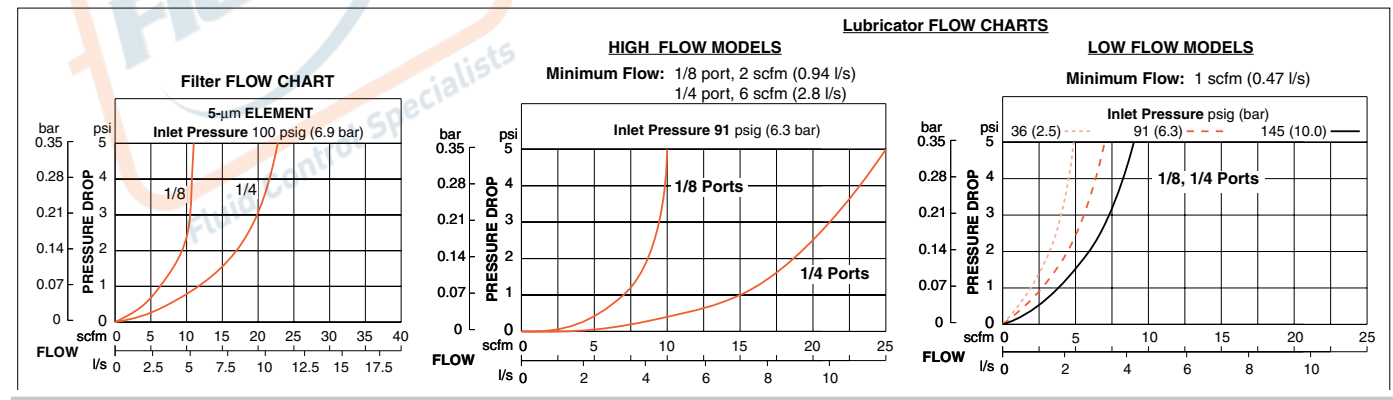

Pressure Gauge included.
Accessories ordered separately, refer to page G6.3-4.

STANDARD SPECIFICATIONS (for units on this page):

Construction Design	Filter – Fiber Lubricator – Wick-Feed or Quick-Fill Cap	Filter Drain	Internal Automatic drain; Manual drain
Temperature	Ambient/Media: Polycarbonate Bowl: 40° to 125°F (4° to 52°C) Metal Bowl: 40° to 175°F (4° to 80°C)	Pressure Adjustment	Locking Key: Removable
Fluid Media	Compressed air	Oil Adjustment	Internal; tamper-resistant
Operating Pressure	Automatic Drain Models Polycarbonate Bowl: 15 to 150 psig (1 to 10 bar) Metal Bowl: 15 to 200 psig (1 to 14 bar)	Construction Material	Filter Element: 5-micron rated polyethylene
	Manual Drain Models Polycarbonate Bowl: 0 to 150 psig (0 to 10 bar) Metal Bowl: 0 to 200 psig (0 to 14 bar)		Heads: Aluminum Bowl: Polycarbonate or aluminum Seals: Nitrile



บริษัท ฟลูเทค จำกัด
FLU-TECH CO.,LTD

845/3-4 หมู่ 3 ต.เทพารักษ์ ต.เทพารักษ์ อ.เมือง จ.สมุทรปราการ 10270

845/3-4 Thepharak RD., T.Thepharak, A.Muang, Samutprakarn 10270 THAILAND

Tel. 0 2384 6060, Fax 0 2384 5701, Email : sales@flutech.co.th, www.flutech.co.th

G5

G

Modular Filter and Lubricator Combinations

MID-SIZE Series

Port Sizes: 1/4, 3/8 & 1/2 – Flow to 100 scfm

Port Size	Port Threads	Automatic Drain		Manual Drain	
		Polycarbonate Bowl	Metal Bowl	Polycarbonate Bowl	Metal Bowl
		Model Number	Model Number	Model Number	Model Number
1/4	NPTF	5M11B2101	5M11B2202	5M11B2301	5M11B2402
	G	C5M11B2101	C5M11B2202	C5M11B2301	C5M11B2402
3/8	NPTF	5M11B3101	5M11B3202	5M11B3301	5M11B3402
	G	C5M11B3101	C5M11B3202	C5M11B3301	C5M11B3402
1/2	NPTF	5M11B4101	5M11B4202	5M11B4301	5M11B4402
	G	C5M11B4101	C5M11B4202	C5M11B4301	C5M11B4402



Port Size	Bowl Type	Bowl Capacity	Dimensions inches (mm)				Weight † lb (kg)
			A	B	C	Depth †	
1/4, 3/8, 1/2	Polycarbonate	4-oz (120-ml)	5.6 (137)	4.8 (122)	1.8 (46)	2.8 (71)	2.29 (1.04)
	Metal	4-oz (120-ml)	5.6 (137)	4.9 (123)	1.8 (46)	2.8 (71)	3.10 (1.41)

† Less gauge.

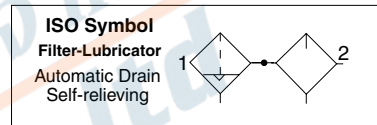

REPLACEMENT FILTER ELEMENTS		
Element Rating	Element Material	Model Number
5-µm - Standard	Polyethylene	936K77
5-µm - Optional	Sintered Bronze	R-KA60F-03E5
20-µm - Optional	Sintered Bronze	R-KA60F-03E4
40-µm - Optional	Sintered Bronze	R-KA60F-03E3

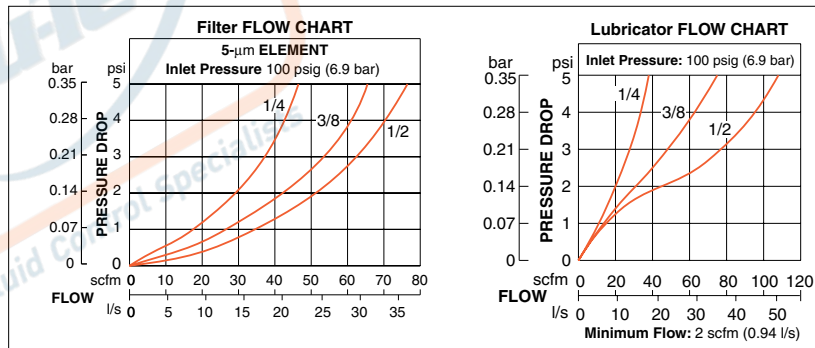
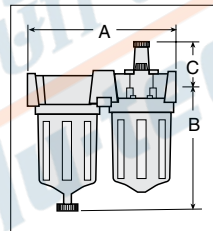

G5

G

Pressure Gauge included.
Includes 2 female port blocks.
Accessories ordered separately, refer to page G6.3-4.

STANDARD SPECIFICATIONS (for units on this page):

Construction Design	Filter – Fiber Lubricator – Sight-Feed	Filter Drain	Internal Automatic drain; Manual drain
Temperature	Ambient/Media: Polycarbonate Bowl: 40° to 125°F (4° to 52°C) Metal Bowl: 40° to 175°F (4° to 80°C)	Oil Adjustment	Internal; tamper-resistant
Fluid Media	Compressed air	Construction Material	Filter Element: 5-micron rated polyethylene Heads: Zinc Bowl: Polycarbonate bowls with zinc shatterguard, or zinc bowls Sight Dome: Clear Nylon Seals: Nitrile
Operating Pressure	Automatic Drain Models Polycarbonate Bowl: 15 to 150 psig (1 to 10 bar) Metal Bowl: 15 to 200 psig (1 to 14 bar) Manual Drain Models Polycarbonate Bowl: 0 to 150 psig (0 to 10 bar) Metal Bowl: 0 to 200 psig (0 to 14 bar)		



บริษัท ฟลูเทค จำกัด
FLU-TECH CO.,LTD

845/3-4 หมู่ 3 ถ.เทพารักษ์ ต.เทพารักษ์ อ.เมือง จ.สมุทรปราการ 10270
 845/3-4 Thepharak RD., T.Thepharak, A.Muang, Samutprakarn 10270 THAILAND
 Tel. 0 2384 6060, Fax 0 2384 5701, Email : sales@flutech.co.th, www.flutech.co.th

Modular Filter and Lubricator Combinations

FULL-SIZE Series

Port Sizes: 1/4, 3/8, 1/2 & 3/4 – Flow to 138 scfm

Port Size	Port Threads	Automatic Drain		Manual Drain	
		Polycarbonate Bowl	Metal Bowl	Polycarbonate Bowl	Metal Bowl
		Model Number	Model Number	Model Number	Model Number
With THREADED PORTS					
1/4	NPTF	5F11B2101	5F11B2202	5F11B2301	5F11B2402
	G	C5F11B2101	C5F11B2202	C5F11B2301	C5F11B2402
3/8	NPTF	5F11B3101	5F11B3202	5F11B3301	5F11B3402
	G	C5F11B3101	C5F11B3202	C5F11B3301	C5F11B3402
1/2	NPTF	5F11B4101	5F11B4202	5F11B4301	5F11B4402
	G	C5F11B4101	C5F11B4202	C5F11B4301	C5F11B4402
3/4	NPTF	5F11B5101	5F11B5202	5F11B5301	5F11B5402
	G	C5F11B5101	C5F11B5202	C5F11B5301	C5F11B5402
With PIPE NIPPLES					
1/4	NPTF	5F00B2101	5F00B2202	5F00B2301	5F00B2402
	G	C5F00B2101	C5F00B2202	C5F00B2301	C5F00B2402
3/8	NPTF	5F00B3101	5F00B3202	5F00B3301	5F00B3402
	G	C5F00B3101	C5F00B3202	C5F00B3301	C5F00B3402
1/2	NPTF	5F00B4101	5F00B4202	5F00B4301	5F00B4402
	G	C5F00B4101	C5F00B4202	C5F00B4301	C5F00B4402
3/4	NPTF	5F00B5101	5F00B5202	5F00B5301	5F00B5402
	G	C5F00B5101	C5F00B5202	5F00B5301	C5F00B5402

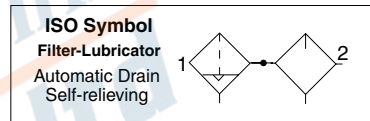

Port Size	Bowl Type	Bowl Capacity	Dimensions inches (mm)				Weight † lb (kg)
			A	B	C	Depth †	
1/4, 3/8, 1/2, 3/4	Polycarbonate	8-oz (240-ml)	7.1 (180)	5.8 (147)	1.3 (33)	2.8 (71)	4.09 (1.86)
	Zinc	8-oz (240-ml)	7.1 (180)	6.4 (163)	1.3 (33)	2.8 (71)	5.9 (2.68)

† Less gauge.

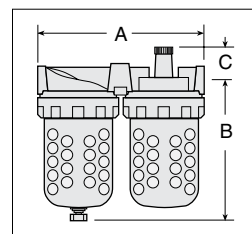

REPLACEMENT FILTER ELEMENTS		
Element Rating	Element Material	Model Number
5-µm - Standard	Polyethylene	939K77
5-µm - Optional	Sintered Bronze	R-KA103-03E5
20-µm - Optional	Sintered Bronze	R-KA103-03E4
40-µm - Optional	Sintered Bronze	R-KA103-03E3

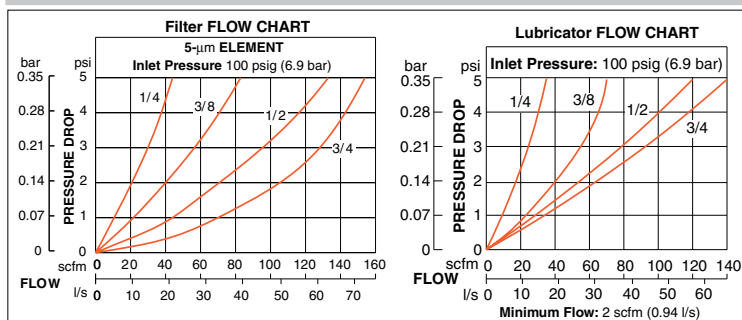

Pressure Gauge included. Units with Threaded Ports Include 2 female port blocks.
Options: Electronic Drain, refer to page G6.7.
Accessories ordered separately, refer to page G6.3-4.

STANDARD SPECIFICATIONS (for units on this page):

Construction Design	Filter – Fiber Lubricator – Sight-Feed	Filter Drain	Internal Automatic or Manual
Temperature	Ambient/Media:	Pressure Gauge	0 to 200 psig (0 to 14 bar); 1/4 NPT gauge ports front and rear
	Polycarbonate Bowl: 40° to 125°F (4° to 52°C) Metal Bowl: 40° to 175°F (4° to 80°C)	Pressure Adjustment	Locking Key: Removable
Fluid Media	Compressed air	Oil Adjustment	Internal; tamper-resistant
Operating Pressure	Automatic Drain Models	Construction Material	Filter Element: 5-micron rated polyethylene
	Polycarbonate Bowl: 15 to 150 psig (1 to 10 bar) Metal Bowl: 15 to 200 psig (1 to 14 bar)		Heads: Zinc
Manual Drain Models	Bowl: Polycarbonate bowl with steel shatterguard, or zinc bowl with clear nylon sight glass		
Polycarbonate Bowl: 0 to 150 psig (0 to 10 bar) Metal Bowl: 0 to 200 psig (0 to 14 bar)	Bowl Rings: Aluminum		
Outlet Pressure	Adjustable up to 125 psig (9 bar).		Regulator Dome: Nylon
			Regulator Knob: Acetal
		Sight Dome: Clear Nylon	
		Seals: Nitrile	



บริษัท ฟลูเทค จำกัด
FLU-TECH CO.,LTD

845/3-4 หมู่ 3 ถ.เทพารักษ์ ต.เทพารักษ์ อ.เมือง จ.สมุทรปราการ 10270

845/3-4 Thepharak RD., T.Thepharak, A.Muang, Samutprakarn 10270 THAILAND
Tel. 0 2384 6060, Fax 0 2384 5701, Email : sales@flutech.co.th, www.flutech.co.th

G5

G

In-line Filter and Lubricator Combinations

HIGH-CAPACITY Series

Port Sizes: 3/4 & 1 – Flow to 270 scfm

Port Size	Port Threads	Automatic Drain		Manual Drain	
		Polycarbonate Bowl	Metal Bowl	Polycarbonate Bowl	Metal Bowl
		Model Number	Model Number	Model Number	Model Number
3/4	NPTF	5H00B5101	5H00B5202	5H00B5301	5H00B5402
	G	C5H00B5101	C5H00B5202	C5H00B5301	C5H00B5402
1	NPTF	5H00B6101	5H00B6202	5H00B6301	5H00B6402
	G	C5H00B6101	C5H00B6202	C5H00B6301	C5H00B6402



Port Size	Bowl Type	Bowl Capacity	Dimensions inches (mm)				Weight † lb (kg)
			A	B	C	Depth †	
3/4, 1	Polycarbonate	16-oz (480-ml)	9.2 (234)	8.0 (204)	1.4 (37)	4.3 (108)	5.27 (2.39)
	Aluminum	16-oz (480-ml)	9.2 (234)	8.3 (210)	1.4 (37)	4.3 (108)	6.3 (2.86)

† Less gauge.

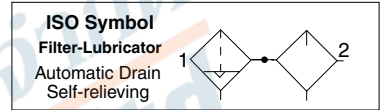

REPLACEMENT FILTER ELEMENTS		
Element Rating	Element Material	Model Number
5-µm - Standard	Polyethylene	1010K77
5-µm - Optional	Sintered Bronze	R-KA109-03E5
20-µm - Optional	Sintered Bronze	R-KA109-03E4
40-µm - Optional	Sintered Bronze	R-KA109-03E3

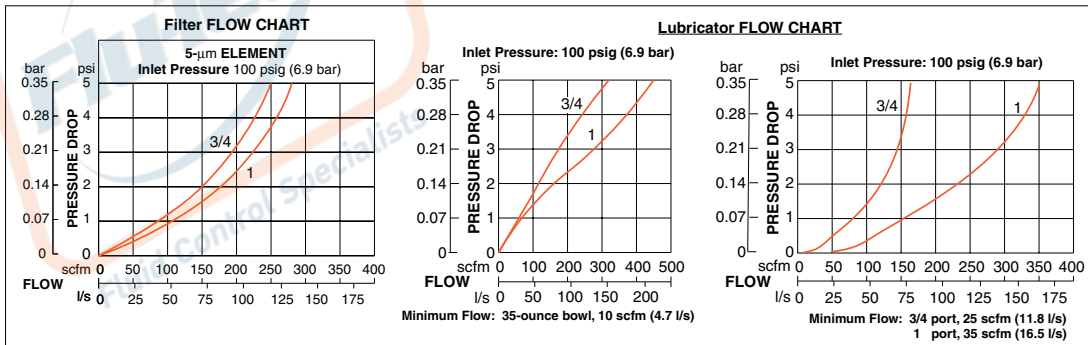
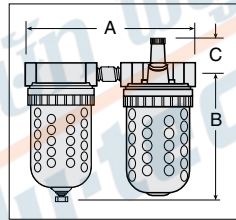

G5

G

Pressure Gauge included.
Options: Automatic External Drain, Electronic Drain, refer to page G6.7.
Accessories ordered separately, refer to page G6.3-4.

STANDARD SPECIFICATIONS (for units on this page):

Construction Design	Filter – Fiber Lubricator – Wick-Feed	Filter Drain	Automatic, or Manual
Temperature	Ambient/Media: Polycarbonate Bowl: 40° to 125°F (4° to 52°C) Metal Bowl: 40° to 175°F (4° to 80°C)	Oil Adjustment	External; tamper-resistant
Fluid Media	Compressed air	Construction Material	Filter Element: 5-micron rated polyethylene
Operating Pressure	Automatic Drain Models Polycarbonate Bowl: 15 to 150 psig (1 to 10 bar) Metal Bowl: 15 to 200 psig (1 to 14 bar)		Heads: Aluminum
	Manual Drain Models Polycarbonate Bowl: 0 to 150 psig (0 to 10 bar) Metal Bowl: 0 to 200 psig (0 to 14 bar)		Bowl: Polycarbonate bowls with steel shatterguard, or aluminum bowls with sight glass Bowl Rings: Aluminum Seals: Nitrile



บริษัท ฟลูเทค จำกัด
FLU-TECH CO.,LTD

845/3-4 หมู่ 3 ถ.เทพารักษ์ ต.เทพารักษ์ อ.เมือง จ.สมุทรปราการ 10270
 845/3-4 Thepharak RD., T.Thepharak, A.Muang, Samutprakarn 10270 THAILAND
 Tel. 0 2384 6060, Fax 0 2384 5701, Email : sales@flutech.co.th, www.flutech.co.th

Mounting Screws for BANTAM Models

Usage Models	Kit Number
BANTAM	859K77

BANTAM models mounts with long screws that extend through end plates.

Mounting Brackets for Regulators and Integrated Filter/Regulators

Regulators and integrated filter/regulators can be mounted to a surface with a bracket that attaches to the regulator. Brackets and mounting panel nuts can be ordered separately or in a kit which includes both bracket and mounting panel nut.

Usage Models	Model Number			Dimensions inches (mm)					Panel Mounting Hole Diameter
	Kit	Bracket	Panel Nut	A	B	C	D	E	
MINIATURE	873K77	872K77	874K77	1.375 (35)	1.125 (29)	0.31 (8)	0.31 (8)	0.69 (17)	1.19 (30)
MID-SIZE	876K77	875K77	877K77	2.38 (60)	1.00 (25)	1.50 (38)	-	-	1.56 (40)
MD3™	R-A127-11	-	R-127-11	2.38 (60)	1.00 (25)	1.50 (38)	-	-	2.06 (52)
FULL-SIZE, MD4™	879K77	878K77	880K77						

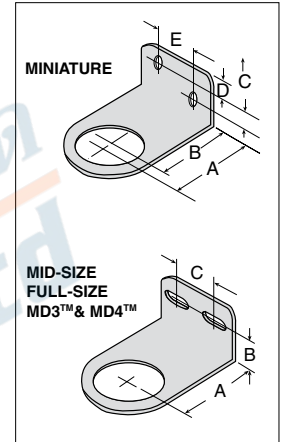

Modular Mounting Brackets for Filters, Regulators, Lubricators, FRL's, or Clean Air Packages

Two L-shaped metal brackets as shown at the right can be used for wall mounting of modular FRLs or Clean Air Packages. A single bracket can be used to mount individual filters or lubricators. Kits include two brackets and four screws for attaching the brackets to the modules.

Usage Models	Kit Number	Dimensions inches (mm)			
		A	B	C	D
MID-SIZE & FULL-SIZE	915K77	3.0 (76)	0.88 (22)	1.00 (25)	1.20 (31)

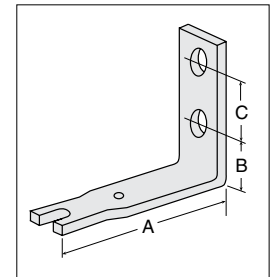

FRLs In-line Mounting Pipe Brackets

Two pipe brackets can be used for wall mounting of FRLs assemblies that use pipe nipples to join the components. The bracket kits listed below include two sets of brackets.

Nipple Size	Kit Number	Dimensions inches (mm)		
		A	B	C
1/4	887K77	2.72 (28)	0.50 (13)	1.00 (25)
3/8	888K77			
1/2	889K77			
3/4	890K77	3.69 (94)	1.13 (29)	1.25 (32)
1	891K77			

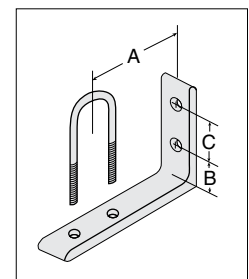

Bracket Assembly Kit for HIGH-RELIEF Pilot Operated Regulator

High-Relief Pilot Operated Regulator with 1/4- thru 1 1/4 inch ports can be mounted to a vertical surface using a bracket assembly kit.

Kit Number	R-A37-381
------------	-----------



MID-SIZE and FULL-SIZE Units

The modular designs of the MID-SIZE and FULL-SIZE series offer maximum flexibility in customizing FRLs assemblies. As shown at the right, connector kits are required to interconnect units. Various port kits (shown below) can be used to connect the assemblies to the inlet and outlet piping. Note that all FRLs components have threaded ports so that conventional pipe fittings may be used where desired.

Female Port Block

Used to connect to piping at inlet or outlet.

Port Size	Model Number	
	NPTF Threads	G Threads
1/4	897K77	D897K77
3/8	898K77	D898K77
1/2	899K77	D899K77
3/4	900K77	D900K77



Male Port Block

Used to connect modular to non-modular units.

Port Size	Model Number	
	NPTF Threads	G Threads
1/4	893K77	D893K77
3/8	894K77	D894K77
1/2	895K77	D895K77
3/4	896K77	D896K77



Connector Kit

Used to connect units to one another as well as to any of the ports shown on this page.

Kit Number 892K77



BANTAM Units

BANTAM modular units use end plates secured with screws to hold the pipe or tubing ports (see below), and also to serve as mounting brackets. Short screws are used to secure the end plates when a single BANTAM unit is used. If two or more units are combined, long screws extend through an end plate and thread into the next unit.

Screw kits required are as follows:

Single Unit: Two short screw kits.

Two-Unit Combination: One each short screw kit and long screw kit.

Three-Unit Combination: Two long screw kits.

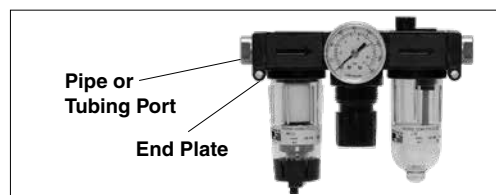

Pipe Ports	
Port Size	Model Number
1/8 NPTF	862K77
1/4 NPTF	863K77
1/8 BSPP	D864K77
1/4 BSPP	D865K77

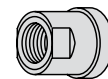

Pipe Ports	
Kit Description	Model Number
END PLATE (1)	857K77
Short Screw (2)	858K77
Long Screw (2)	859K77
Small O-Ring (for inlet or mating ports)	860K77
Large O-Ring (for outlet or mating ports)	861K77

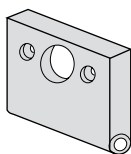

Tube Ports	
Port Size	Model Number
1/4	866K77
3/8	867K77
4 mm	868K77
6 mm	869K77
8 mm	870K77
10 mm	871K77

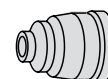

Modular Assemblies

Accessories: Clamp, Brackets, End Ports & Port Blocks

MD Series

Dimensions: inches (mm)

MD3™ Series

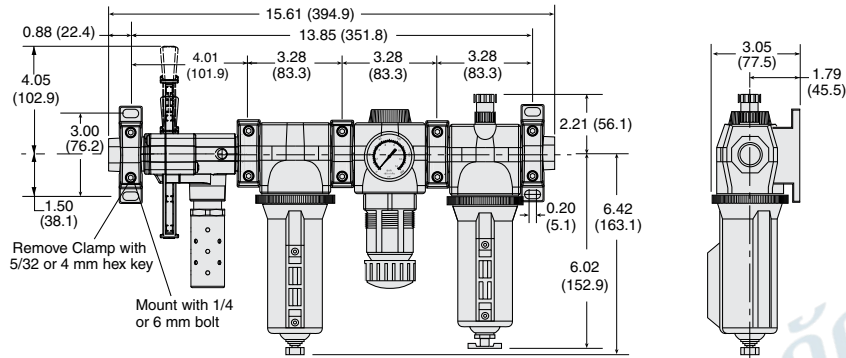

MD4™ Series

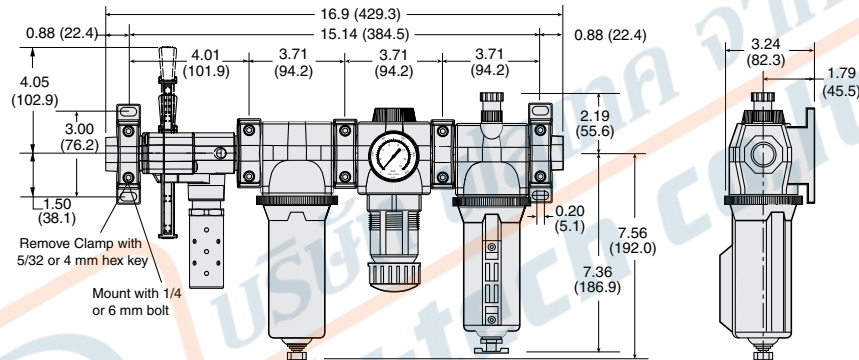

Mounting Brackets & Clamp for Module Connections

Two brackets are normally used to mount an FRL to a vertical surface. The mounting bracket attaches to the module connecting clamp (see above) with a single screw. Each bracket then employs two bolts (1/4" or 6mm) to connect the assembly to the mounting surface. Specially designed clamps provide a quick and easy assembly or disassembly of MD3™ modules. Two Allen-Head bolts quickly tighten or loosen the clamp using a 5/32 or 4mm hex key. The clamp contains a plate carrying two O-rings to provide positive sealing between modules.



Bracket, Screw, and Clamp



Module Connecting Clamp



Mounting Bracket

Mounting Brackets & Clamp for Module Connections

Description	Model Number
Bracket and Screw	R-A118-103
Module Connecting Clamp	R-A118-105
Bracket, Screw, and Clamp	R-A118-105M

Male and Female End Ports

Either male or female end ports can be attached to threaded inlet and outlet lines. This allows all modules of an FRL assembly to be removed easily and quickly without having to unthread the end modules. The end ports are attached to the modules with clamps (see at left). End ports can be included in an assembled FRL or ordered separately by the following model numbers:

Type	Port Size	Model Number		
		NPTF Threads	G Threads	
Female	1/4	R-118-100-2	R-118-100-2W	
	3/8	R-118-100-3	R-118-100-3W	
	1/2	R-118-100-4	R-118-100-4W	
	3/4	R-118-100-6	R-118-100-6W	
Male	1/4	R-118-109-2F	R-118-109-2FW	
	3/8	R-118-109-3F	R-118-109-3FW	
	1/2	R-118-109-4F	R-118-109-4FW	
	3/4	R-118-109-6F	R-118-109-6FW	

Extra Port Blocks

An extra port block can be placed between modules to provide two auxiliary 1/4 NPTF ports. Its mounting position can be rotated to obtain the most convenient operating orientation. If only one auxiliary port is to be used, the unused port must be closed with a pipe plug. (The inlet and outlet are not threaded.)

Port Size	Model Number	
	NPTF Threads	G Threads
1/4	R-118-106-2	R-118-106-2W
3/8	R-118-106-3	R-118-106-3W
1/2	R-118-106-4	R-118-106-4W



บริษัท ฟลูเทค จำกัด
FLU-TECH CO.,LTD

845/3-4 หมู่ 3 ถ.เทพารักษ์ ต.เทพารักษ์ อ.เมือง จ.สมุทรปราการ 10270

845/3-4 Thepharak RD., T.Thepharak, A.Muang, Samutprakarn 10270 THAILAND
Tel. 0 2384 6060, Fax 0 2384 5701, Email : sales@flutech.co.th, www.flutech.co.th

Analog Pressure Gauges

Pressure Gauges (Center Back Mounting)	Type/Material	Port Size	Model Number		Pressure Range psig (bar)	Case Diameter inches (mm)
			Thread			
			NPT	G		
Standard Aluminum		1/8	5400A1002	D5400A1002	0-160 (0-11)	1.7 (43)
		1/4	5400A2010	D5400A2010	0-60 (0-4)	2.0 (51)
		1/4	5400A2011	D5400A2011	0-200 (0-14)	2.0 (51)
		1/4	5400A2012	D5400A2012	0-300 (0-20)	2.0 (51)
Liquid Filled Stainless Steel		1/4	5400A2014	D5400A2014	0-160 (0-11)	2.5 (64)
		1/4	5400A2015*	D5400A2015*	0-160 (0-11)	2.0 (51)

*Green shade between 40-70 psi (2.7-4.8 bar).

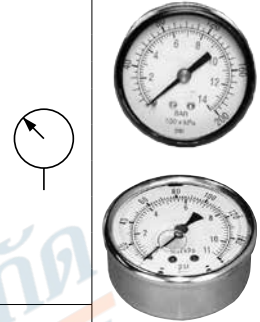

Differential Pressure Gauges

DIFFERENTIAL PRESSURE GAUGE TYPE/SERIES	Small Slide Gauge	Small Slide Gauge	Large Dual Face Gauge	Large Dual Face Gauge with Reed Switch (Normally Open)	Large Dual Face Gauge with Reed Switch (Normally Closed)
	R-A60F-28	R-K103-151	R-106-35	R-106-35E	R-106-35EC
FILTERS					
BANTAM	-	-	-	-	-
MINIATURE	-	-	-	-	-
MID-SIZE	-	-	-	-	-
MD3™	-	-	-	-	-
FULL-SIZE	-	-	-	-	-
MD4™	-	-	-	-	-
HIGH-CAPACITY	-	-	-	-	-
COALESCING FILTERS					
BANTAM	-	-	-	-	-
MINIATURE	-	-	-	-	-
MID-SIZE	-	-	-	-	-
FULL-SIZE	-	-	-	-	-
MD3™	-	-	-	-	-
MD4™	-	-	-	-	-
HIGH-CAPACITY	-	-	-	-	-
OIL VAPOR REMOVAL (ADSORBING) FILTERS					
MD3™	-	-	-	-	-
MD4™	-	-	-	-	-
CLEAN AIR PACKAGES					
MD3™	-	-	-	-	-
MD4™	-	-	-	-	-

G

G6



บริษัท ฟลูเทค จำกัด
FLU-TECH CO.,LTD

845/3-4 หมู่ 3 ถ.เทพารักษ์ ต.เทพารักษ์ อ.เมือง จ.สมุทรปราการ 10270

845/3-4 Thepharak RD., T.Thepharak, A.Muang, Samutprakarn 10270 THAILAND

Tel. 0 2384 6060, Fax 0 2384 5701, Email : sales@flutech.co.th, www.flutech.co.th

External Automatic Drains

Pipe Size	Model Number*	
	Polycarbonate Bowl**	Metal Bowl
1/8	5057B1001	5058B1001
1/4*	5057B2001	5058B2001

*Use 1/4 size with FULL-SIZE, HIGH-CAPACITY, MD3™ & MD4™ filters.
Use kit 1076K77 to convert standard bowl to accept auto drain unit.
**Available for FULL-SIZE filters only. Polycarbonate bowl includes metal bowl guard.

Port Size	Dimensions inches (mm)			Weight lb (kg)
	A	B	C	
1/8, 1/4	3.5 (89)	4.2 (107)	8.3 (211)	2.6 (1.2)

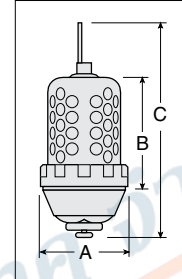

Electronically Controlled Drain

Pipe Size	Voltage	Model Number	
		NPTF Threads	G Threads
1/4	24 volts DC	R-DED-24V-2	R-DED-24V-2W
3/8	24 volts DC	R-DED-24V-3	R-DED-24V-3W
1/2	24 volts DC	R-DED-24V-4	R-DED-24V-4W
1/4	110-120 volts AC, 50/60 Hz	R-DED-115V-2	R-DED-115V-2W
3/8	110-120 volts AC, 50/60 Hz	R-DED-115V-3	R-DED-115V-3W
1/2	110-120 volts AC, 50/60 Hz	R-DED-115V-4	R-DED-115V-4W

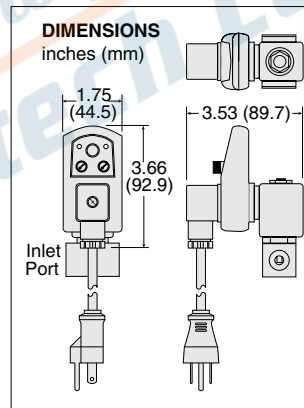

STANDARD SPECIFICATIONS (for electronically controlled drain):

Drain Time	Adjustable 0.5 to 10 seconds	Electrical Connection	DIN 43650A, ISO 440/6952
Drain Interval	0.5 to 45 minutes	Valve Type	2/2 direct acting, normally closed
Current Consumption	Maximum 4 ma	Valve Body	Forged brass; 3/16-inch (4.8 mm) orifice
Temperature	Ambient: 35° to 130°F (2° to 54°C)	Maximum Pressure	230 psig (15.8 bar)
	Media: 35° to 190°F (2° to 88°C)		

Silencers

Port Size	Thread Type	Model Number*		Avg. Cv	Dimensions inches (mm)		Weight lb (kg)
		NPT Threads	R/Rp Threads		Width	Length	
3/8	Male	5500A3003	D5500A3003	4.3	1.3 (32)	3.5 (88)	0.2 (0.1)
3/4	Male	5500A5013	D5500A5013	5.1	1.3 (32)	3.6 (92)	0.2 (0.1)
3/4	Male	5500A5003	D5500A5003	11.5	2.0 (51)	5.3 (135)	0.6 (0.3)

Flow Media: Filtered air.
Pressure Range: 0 to 290 psig (0 to 20 bar) maximum.



G

G6



บริษัท ฟลูเทค จำกัด
FLU-TECH CO.,LTD

845/3-4 หมู่ 3 ถ.เทพารักษ์ ต.เทพารักษ์ อ.เมือง จ.สมุทรปราการ 10270

845/3-4 Thepharak RD., T.Thepharak, A.Muang, Samutprakarn 10270 THAILAND
Tel. 0 2384 6060, Fax 0 2384 5701, Email : sales@flutech.co.th, www.flutech.co.th

Replacements Filter Elements

FRL's Series

Category	Series	Bowl Type	Element Rating	Element Material	Model Number
Filters	Bantam & Miniature	Standard	5-µm	Polyethylene	933K77
			5-µm	Sintered Bronze	R-KA130-27E5
			20-µm	Sintered Bronze	R-KA130-27E4
			40-µm	Sintered Bronze	R-KA130-27E3
	MID-SIZE	Standard	5-µm	Polyethylene	936K77
	MD3™	Standard	5-µm	Polyethylene	R-A60F-03PE5
			5-µm	Sintered Bronze	R-A60F-03E5
			20-µm	Sintered Bronze	R-A60F-03E4
			40-µm	Sintered Bronze	R-A60F-03E3
	FULL-SIZE	Standard	5-µm	Polyethylene	939K77
			5-µm	Sintered Bronze	R-KA103-03E5
			20-µm	Sintered Bronze	R-KA103-03E4
			40-µm	Sintered Bronze	R-KA103-03E3
	MD4™	Standard	5-µm	Polyethylene	R-A115-106PE5
			5-µm	Sintered Bronze	R-A115-106E5
			20-µm	Sintered Bronze	R-A115-106E4
			40-µm	Polyethylene	R-A115-106PE3
	HIGH-CAPACITY Flow to 275 scfm	Standard	5-µm	Polyethylene	1010K77
			5-µm	Sintered Bronze	R-KA109-03E5
			20-µm	Sintered Bronze	R-KA109-03E4
40-µm			Sintered Bronze	R-KA109-03E3	
HIGH-CAPACITY Flow to 660 scfm	Standard	5-µm	Sintered Bronze	1656K77	
		40-µm	Sintered Bronze	R-A114-106E3	
HIGH-CAPACITY Flow to 1000 scfm	Standard	5-µm	Sintered Bronze	942K77	
		40-µm	Sintered Bronze	944K77	
Coalescing Filters	Bantam & Miniature	Standard	0.3-µm	Borosilicate-glass-fiber	945K77
			0.01-µm	Borosilicate-glass-fiber	R-A-10F-16E8
	MID-SIZE	Standard	0.3-µm	Borosilicate-glass-fiber	R-A60F-29
			Extended	0.3-µm	Borosilicate-glass-fiber
		Standard	0.01-µm	Borosilicate-glass-fiber	R-A60F-29E8
			Extended	0.01-µm	Borosilicate-glass-fiber
	MD3™	Polycarbonate	0.3-µm	Borosilicate-glass-fiber	R-A60F-23
			Metal	0.3-µm	Borosilicate-glass-fiber
		Extended Metal	0.3-µm	Borosilicate-glass-fiber	R-A60F-32
			Polycarbonate	0.01-µm	Borosilicate-glass-fiber
		Metal	0.01-µm	Borosilicate-glass-fiber	R-A60F-29E8
			Extended Metal	0.01-µm	Borosilicate-glass-fiber
	FULL-SIZE	Standard	0.3-µm	Borosilicate-glass-fiber	947K77
			Extended	0.3-µm	Borosilicate-glass-fiber
		Standard	0.01-µm	Borosilicate-glass-fiber	948K77
			Extended	0.01-µm	Borosilicate-glass-fiber
	MD4™	Standard	0.3-µm	Borosilicate-glass-fiber	R-A115-117
			Extended	0.3-µm	Borosilicate-glass-fiber
		Standard	0.01-µm	Borosilicate-glass-fiber	R-A115-117E8
			Extended	0.01-µm	Borosilicate-glass-fiber
	HIGH-CAPACITY Flow to 220 scfm	Standard	0.3-µm	Borosilicate-glass-fiber	949K77
			0.01-µm	Borosilicate-glass-fiber	R-A109-106E8
		Standard	0.3-µm	Borosilicate-glass-fiber	R-A114-112
			Extended	0.3-µm	Borosilicate-glass-fiber
	HIGH-CAPACITY Flow to 295 & 450 scfm	Standard	0.01-µm	Borosilicate-glass-fiber	R-A114-112E8
			Extended	0.01-µm	Borosilicate-glass-fiber
		Standard	0.3-µm	Borosilicate-glass-fiber	952K77
			Extended	0.3-µm	Borosilicate-glass-fiber
HIGH-CAPACITY Flow to 465 scfm	Standard	0.01-µm	Borosilicate-glass-fiber	R-A106-24E8	
		Extended	0.01-µm	Borosilicate-glass-fiber	R-A106-24LE8
	Extended	0.3-µm	Borosilicate-glass-fiber	953K77	
HIGH-CAPACITY Flow to 840 scfm	Extended	0.3-µm	Borosilicate-glass-fiber	953K77	
		0.01-µm	Borosilicate-glass-fiber	R-A106-24E8	
Oil Vapor Removal Filters	MD3™	Standard	–	Borosilicate-glass-fiber	R-A60F-29E9
		Extended	–	Borosilicate-glass-fiber	R-A60F-32E9
	MD4™	Standard	–	Borosilicate-glass-fiber	R-A115-117E9
		Extended	–	Borosilicate-glass-fiber	R-A115-118E9
Silencers Reclassifiers	Port Size 1/2	Standard	20-µm	Sintered Bronze	940K77
	Port Size 3/4, 1		100-µm	Sintered Bronze	981K77

G