



PID+Fuzzy



WWW.FLUTECH.CO.TH

LINE ADD FRIEND @flutech.co.th

Authorized Distributor



Display Scaling Meter / Temperature Controller



DISPLAY SCALING METER INTRODUCTION

FEATURES

Adapts microprocessor control circuit, modular design, advanced digital calibration, and switching power supply technology.

Modulized design is a concept to adapt different analog input signals by means of changing different signal board (such as temperature, pressure, alternating voltage, electric current.). Also, optional output board could add the analog output signal (isolated). By using advanced digital calibration capability, its analog input/output could be accurate to +/- 1 bit.

PB SERIES---BARGRAPH DISPLAY

It is easy to tell the measuring, operator can tell measuring range easily by eyesight even in the remote site.

Provides not only 4 digits numerical display with bargraph analog output indicator but also 6 relay setting points. It makes users to tell Process setting position without difficulties by bargraph indicator. In general, it is an easy applied and understand model to customers.

PB-1470 are horizontal mounting design, all functions are same as vertical models.

PM SERIES---DIGITAL DISPLAY

PM-1430 are single channel models with 5-digit or 4 digit LED display respectively.

NON-LINEAR TANK VOLUME CONVERSION FEATURE

NON-LINEAR TANK VOLUME CONVERSION FEATURE

PM/PB Series support volume adjustment function for non-linear tanks. By means of a 20-point look-up table, panel meter calculate tank volume according to the material level measured.

Bundled with this package, a software is provided, user simply select tank type shown as below, and enter necessary dimension, tank volume and 20 control points will be calculated and reported.

TANK TYPE:

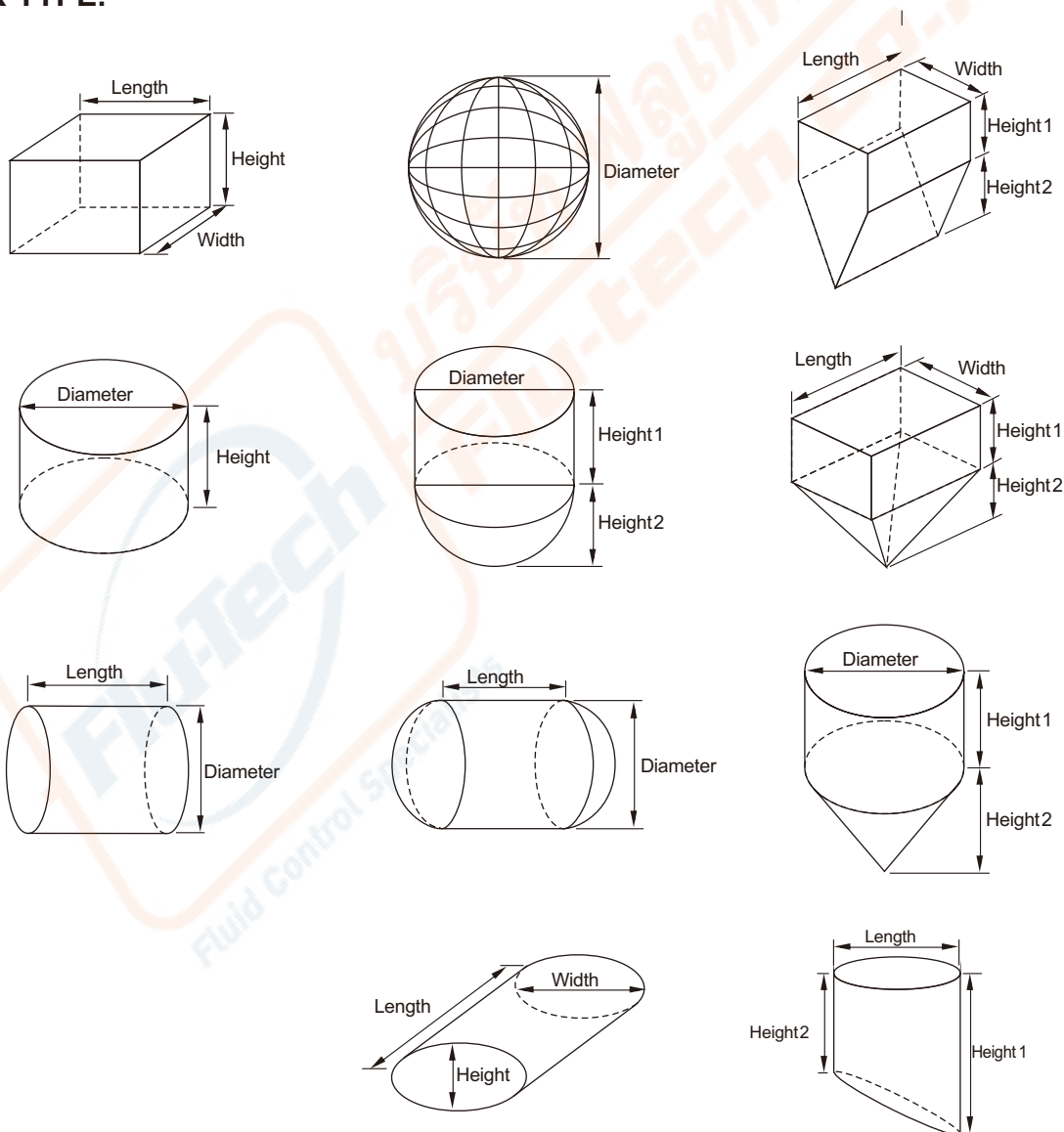

SPECIFICATIONS

	Microprocessor Bargraph Display Panel Meter	Microprocessor Digit Display Panel Meter
Appearance		
Dimension (mm)	DIN 3/16 48 (W) x144 (H) x121.5 (D)	DIN 1/8 96 (W) x48 (H) x128.5 (D)
Model	PB-1471	PM-1430
Display	4 Digits 7-Segment LED 101 LED Bargraph Display Totally 6 Set Points	Display 4-Digit, 7 Segment LED 4 Relay Setpoints Max. - LED
Standard	Display range	-1999 ~ +9999
	Input signal	Refer to Input Signal Selection in Order Information (Page 6)
	Relay contact	Up to 4 Relays (as standard), SPST (N.O. or N.C. Jumper Selectable), 3A@250VAC/5A@30VDC
Optional	Power supply	85~265VAC or 18~36VDC
	Relay	Expand to 6 Relay
	Analog output	0/4~20mA or 0~10VDC
	Communication port	RS485 MODBUS
	Non-Linear Function	20-Point Linearization for Non-Linear Tanks

PB-1471 Microprocessor Bargraph Display Panel Meter



FEATURES:

- 4 Digits LED Numeric Display
- 101-segment LED Bargraph display
- Wide Range of User Definable Scaling Ratio
- Modulized input signal boards available for different applications
- Optional Output Boards with Isolated Analog Output & Relay Output
- 85V~265VAC or 18~36VDC Switching Power Supply
- Support volume adjustment function for non-linear tanks (optional)

TERMINAL ARRANGEMENTS:

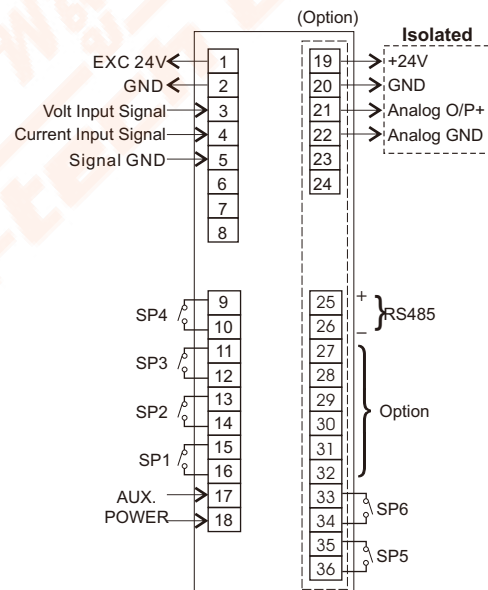

SPECIFICATIONS

Dimension (mm)	48 (W) x144 (H) x121.5 (D) DIN 3/16
Model	PB-1471
Power SUPply	85 ~ 265V AC or 18~36V DC Switching Power Supply
Power supply for sensor	DC24V, 50mA
Display	4 Digits, 0.36" 7-Segment red LED Display 101 LED Bargraph Display 6 LED set-point indicator Display Range: -1999 ~ +9999 Over Range Display: "1" or "-1"
Input signal	Range: Refer to Ordering information Accuracy: 0.1%FS or ± 1 digit Temperature coefficient: 200ppm/ $^{\circ}$ C ADC Resolution: 4-1/2 digit Sampling Rate: 4 samples/second/channel
Relay contact	4 relay (up to 6 relay) 3A/250V AC or 5A/30V DC (N.C. / N.O. Jumper selectable)
Analog output	4~20mA, 0~20mA, 2~10V and 0~10V (optional)
Power consumption	Less than 9VA
Communication port	RS485 (optional) Modbus Protocol
Operating condition	0~50 $^{\circ}$ C(20 to 90% RH non-condensed)
Storage condition	0~70 $^{\circ}$ C(20 to 90% RH non-condensed)

EXTERIOR/CUTOUT DIMENSIONS

(Unit:mm)

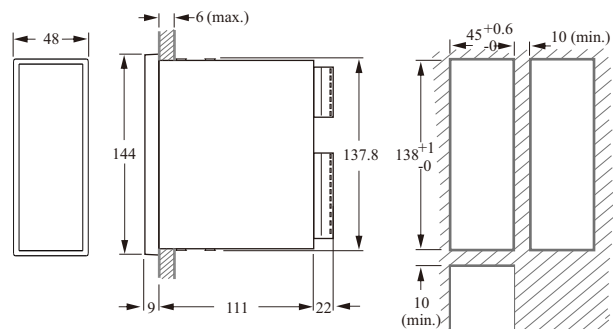

PM-1430 Microprocessor Digit Display Panel Meter



FEATURES:

- 4 Digits LED Numeric Display
- Wide Range of User Definable Scaling Ratio
- Modulized input signal boards available for different applications
- Optional Output Boards with Isolated Analog Output & Relay Output
- 85V~265VAC or 18~36VDC Switching Power Supply
- Support volume adjustment function for non-linear tanks (optional)
- IP54 Class front panel

TERMINAL ARRANGEMENTS:

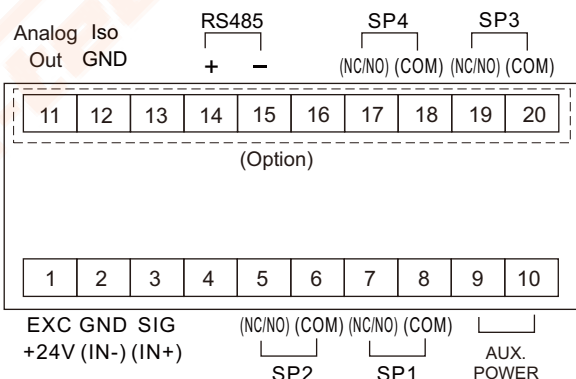

SPECIFICATIONS

Dimension (mm)	96 (W) x48 (H) x128.5 (D) DIN 1/8
Model	PM-1430
Power supply	85 ~ 265V AC or 18~36V DC Switching Power Supply
Power supply for sensor	DC24V, 50mA
Display	4 Digits, 0.56" 7-Segment red LED Display 4 LED set-point indicator Display Range: -1999 ~ +9999 Over Range Display: "1" or "-1"
Input signal	Range: Refer to Ordering information Accuracy: 0.1%FS or ± 1 digit Temperature coefficient: 200ppm/ $^{\circ}$ C ADC Resolution: 4-1/2 digit Sampling Rate: 4 samples/second/channel
Relay contact	2 or 4 relay 3A/250V AC or 5A/30V DC (N.C. / N.O. Jumper selectable)
Analog output	4~20mA, 0~20mA, 2~10V and 0~10V (optional)
Power consumption	Less than 7VA
Communication port	RS485 (optional) Modbus Protocol
Operating condition	0~50 $^{\circ}$ C(20 to 90% RH non-condensed)
Storage condition	0~70 $^{\circ}$ C(20 to 90% RH non-condensed)

EXTERIOR/CUTOUT DIMENSIONS

(Unit:mm)

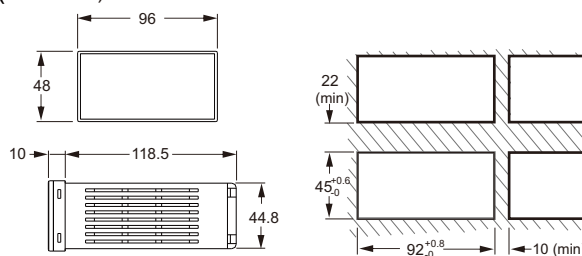

MODEL NUMBER / ORDER CODE COMPARISON TABLE

ORDER INFORMATION

Model Number	Order Code
PB-1471	PBX11400-B6

PBX1 1 4 0 0 - B 6 ¹¹ ¹² ¹³ 0 0 ¹⁶ ¹⁷ ¹⁸ ¹⁹

⑪ Power Supply

- A: 85~265Vac
- B: 18~36Vdc

(Next page)

⑫⑬ Single channel input

- A1: 4~20mA DC with Exc 24V
- A2: 0~20mA DC with Exc 24V
- A3: 0~200mA DC with Exc 24V
- A4: 0~5V DC with Exc 24V
- A5: 0~10V DC with Exc 24V
- A6: 0~20V DC with Exc 24V
- A7: 0~200V DC with Exc 24V
- B1: 0~2mA AC RMS
- B2: 0~20mA AC RMS
- B3: 0~200mA AC RMS
- B4: 0~1A AC RMS
- B5: 0~5A AC RMS
- C1: 0~100mV AC RMS
- C2: 0~200mV AC RMS
- C3: 0~2V AC RMS
- C4: 0~20V AC RMS
- C5: 0~200V AC RMS
- C6: 0~600V AC RMS
- D1: 0~±2 mA DC with Exc 24V
- D2: 0~±20 mA DC with Exc 24V
- D3: 0~±200 mA DC with Exc 24V
- D4: 0~±1Amp DC
- D5: 0~±5Amp DC
- E1: 0~±20mV DC with Exc 24V
- E2: 0~±50mV DC with Exc 24V
- E3: 0~±100mV DC with Exc 24V
- E4: 0~±200mV DC with Exc 24V

ORDER INFORMATION

PBX1 1400 - B 6 0 0

⑩ **Relay contact**

- A: None
- C: 2 Relay
- E: 4 Relay
- G: 6 Relay

⑪ **Non-Linear function**

- A: None
- B: Non - linear bucket conversion

⑫ **Analog output**

- A: None
- B: 0~10V output
- C: 0/4~20mA output

⑬ **Communi-cation port**

- A: None
- B: RS-485

MODEL NUMBER / ORDER CODE COMPARISON TABLE

ORDER INFORMATION

Model Number	Order Code
PM-1430	PMX11400-E2

PMX 1 1 4 0 0 - E 2 ^⑪ ^⑫ ^⑬ 0 0 ^⑰ ^⑱ ^⑲ ^⑳

⑪ Power Supply

- A: 85~265Vac
- B: 18~36Vdc

(Next page)

⑫⑬ Single channel input

- A1: 4~20mA DC with Exc 24V
- A2: 0~20mA DC with Exc 24V
- A3: 0~200mA DC with Exc 24V
- A4: 0~5V DC with Exc 24V
- A5: 0~10V DC with Exc 24V
- A6: 0~20V DC with Exc 24V
- A7: 0~200V DC with Exc 24V
- B1: 0~2mAAC RMS
- B2: 0~20mAAC RMS
- B3: 0~200mAAC RMS
- B4: 0~1AAC RMS
- B5: 0~5AAC RMS
- C1: 0~100mV AC RMS
- C2: 0~200mV AC RMS
- C3: 0~2V AC RMS
- C4: 0~20V AC RMS
- C5: 0~200V AC RMS
- C6: 0~600V AC RMS
- D1: 0~±2 mA DC with Exc 24V
- D2: 0~±20 mA DC with Exc 24V
- D3: 0~±200 mA DC with Exc 24V
- D4: 0~±1Amp DC
- D5: 0~±5Amp DC
- E1: 0~±20mV DC with Exc 24V
- E2: 0~±50mV DC with Exc 24V
- E3: 0~±100mV DC with Exc 24V
- E4: 0~±200mV DC with Exc 24V

ORDER INFORMATION

PMX 1 1 4 0 0 - E 2 0 0

⑩ **Relay contact**

- A: None
- C: 2 Relay
- E: 4 Relay

⑪ **Non-Linear function**

- A: None
- B: Non - linear bucket conversion

⑫ **Analog output**

- A: None
- B: 0~10V output
- C: 0/4~20mA output

⑬ **Communication port**

- A: None
- B: RS-485

PB DC SIGNAL INPUT MODULE

This section will elaborate how to adapt to different input signals in the PB series panel meter, by using the correct jumper and using iSEL command. Panel meter series can accommodate 6 types of conventional input signals, 20mA, 200mA, 5V, 10V, 20V, 200V, please refer below for setup.

Single Channel Signal Input Module: (For PB-1471)

01: 4~20mA DC with Excitation +24V

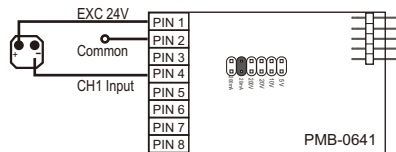

02: 0~20mA DC with Excitation +24V

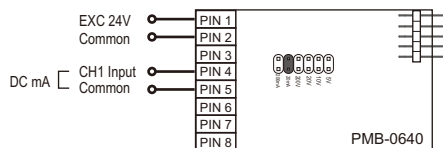

03: 0~200mA DC with Excitation +24V

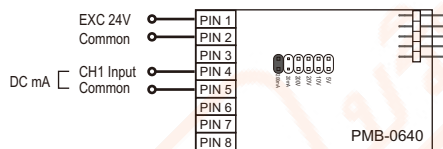

04: ± 5V DC with Excitation +24V

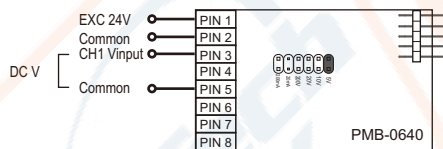

05: ± 10V DC with Excitation +24V

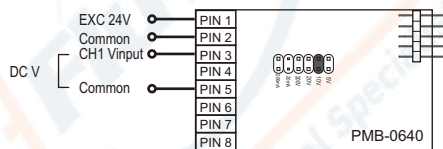

06: ± 20V DC with Excitation +24V

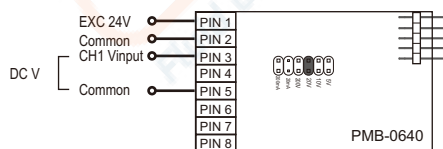

07: ± 200V DC with Excitation +24V

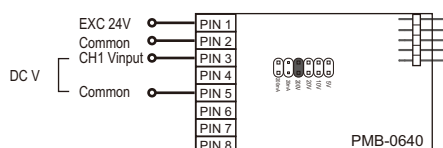

PB AC SIGNAL INPUT MODULE

This section will elaborate how to adapt to different input signals in the PB series panel meter, by using the correct jumper and using iSEL command. Panel meter series can accommodate 6 types of conventional input signals, 20mA, 200mA, 5V, 10V, 20V, 200V, please refer below for setup.

Single Channel Signal Input Module: (For PB-1471)

A1: 2mA AC Scaled RMS

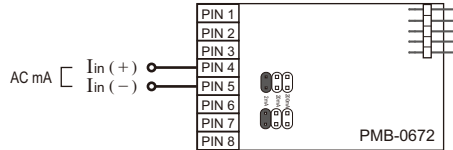

B1: 100mV AC Scaled RMS

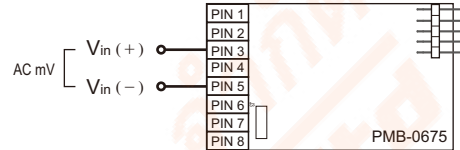

A2: 20mA AC Scaled RMS

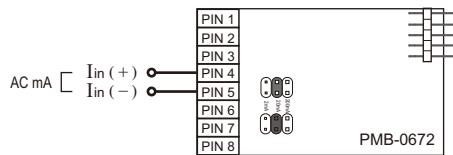

B2: 200mV AC Scaled RMS

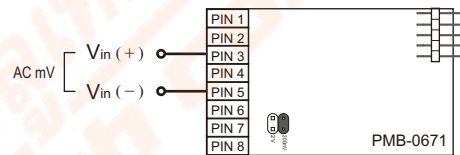

A3: 200mA AC Scaled RMS

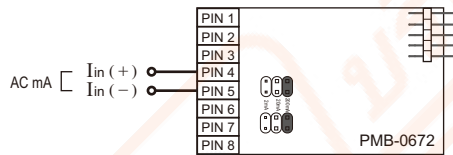

B3: 2V AC Scaled RMS

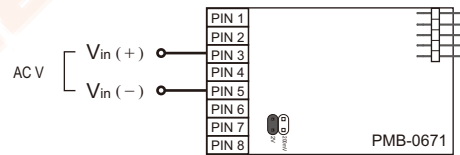

A4: 1Amp AC Scaled RMS

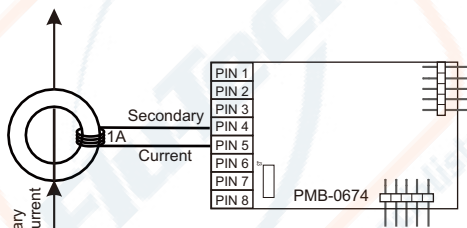

B4: 20V AC Scaled RMS

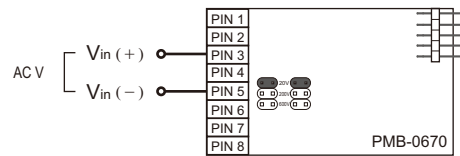

A5: 5 Amp AC Scaled RMS

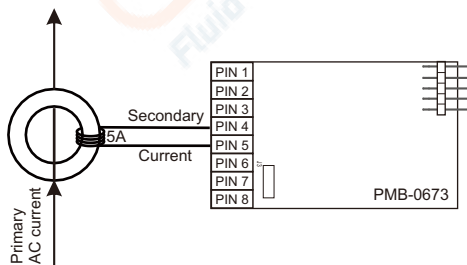

B5: 200V AC Scaled RMS

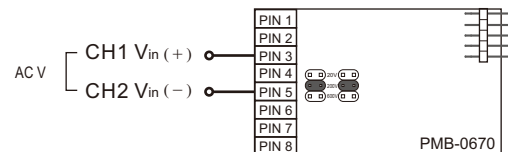

B6: 600V AC Scaled RMS

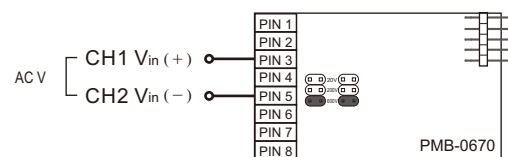

PB DC SIGNAL INPUT MODULE

This section will elaborate how to adapt to different input signals in the PB series panel meter, by using the correct jumper and using iSEL command. Panel meter series can accommodate 6 types of conventional input signals, 20mA, 200mA, 5V, 10V, 20V, 200V, please refer below for setup.

Single Channel Signal Input Module: (For PB-1471)

C1: 2mA DC with Excitation +24V

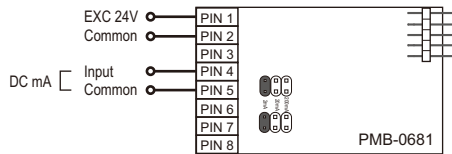

D1: 20 mV DC with Excitation +24V

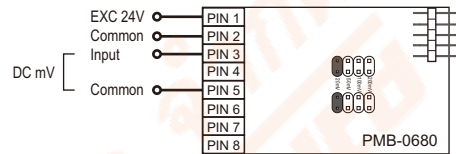

C2: 20mA DC with Excitation +24V

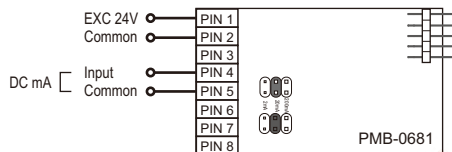

D2: 50 mV DC with Excitation +24V

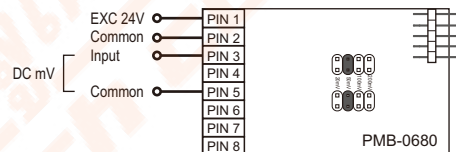

C3: 200mA DC with Excitation +24V

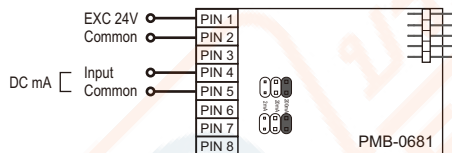

D3: 100 mV DC with Excitation +24V

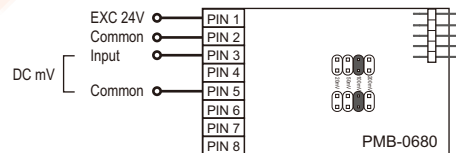

C4: 1A DC

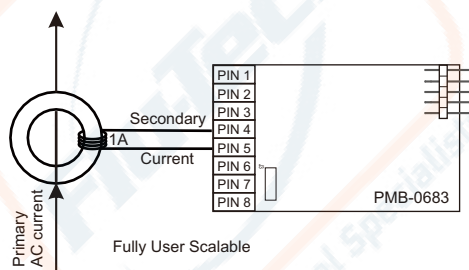

D4: 200 mV DC with Excitation +24V

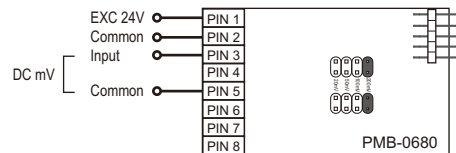

C5: 5A DC

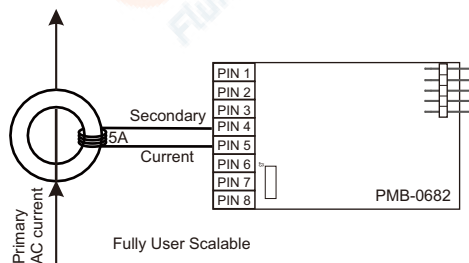

PM DC SIGNAL INPUT MODULE

This section will elaborate how to adapt to different input signals in the PM series panel meter, by using the correct jumper and using iSEL command. Panel meter series can accommodate 6 types of conventional input signals, 20mA, 200mA, 5V, 10V, 20V, 200V, please refer below for setup.

Single Channel Signal Input Module: (For PM-1430)

01: 4~20mA DC with Excitation +24V

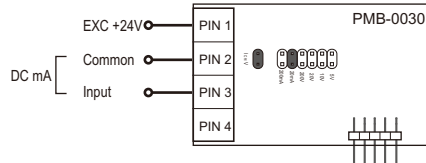

02: 20mA DC with Excitation +24V

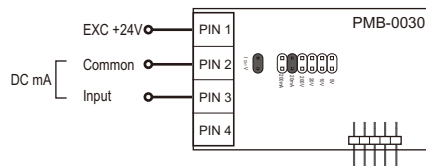

03: 200mA DC with Excitation +24V

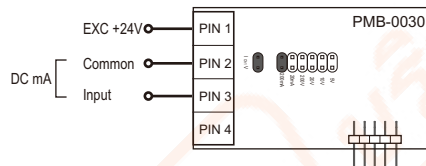

04: 5V DC with Excitation +24V

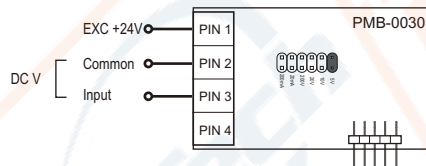

05: 10V DC with Excitation +24V

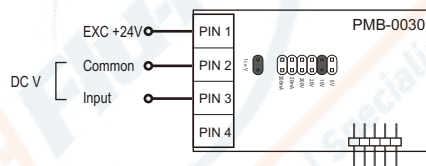

06: 20V DC with Excitation +24V

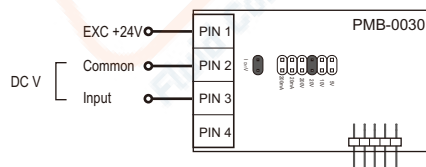

07: 200V DC with Excitation +24V

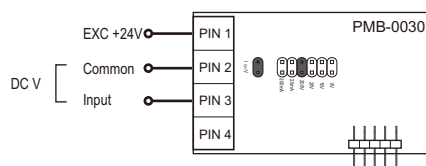

PM AC SIGNAL INPUT MODULE

This section will elaborate how to adapt to different input signals in the PM series panel meter, by using the correct jumper and using iSEL command. Panel meter series can accommodate 6 types of conventional input signals, 20mA, 200mA, 5V, 10V, 20V, 200V, please refer below for setup.

Single Channel Signal Input Module: (For PM-1430)

A1: 2mA AC Scaled RMS

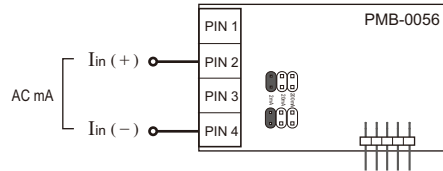

B1: 100mV AC Scaled RMS

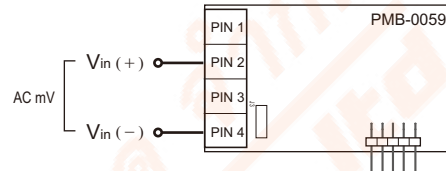

A2: 20mA AC Scaled RMS

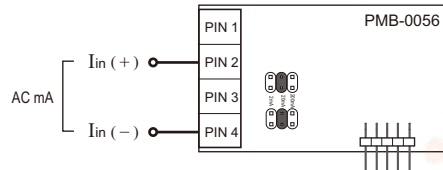

B2: 200mV AC Scaled RMS

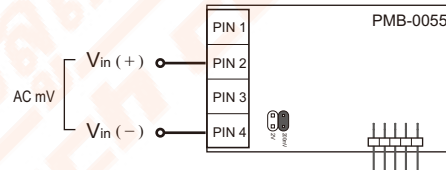

A3: 200mA AC Scaled RMS

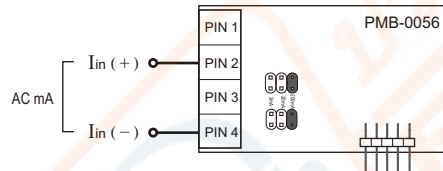

B3: 2V AC Scaled RMS

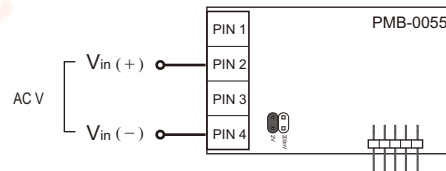

A4: 1Amp AC Scaled RMS

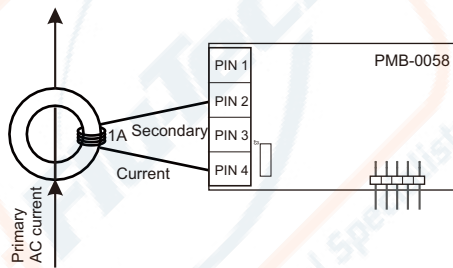

B4: 20V AC Scaled RMS

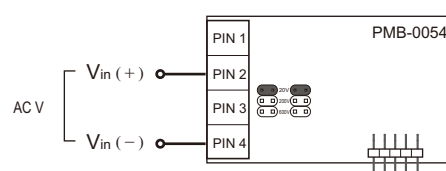

A5: 5 Amp AC Scaled RMS

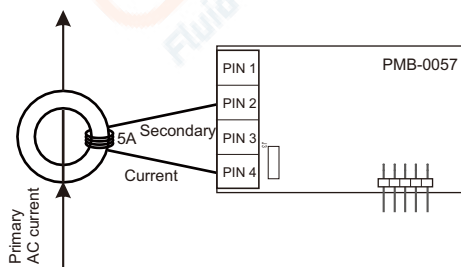

B5: 200V AC Scaled RMS

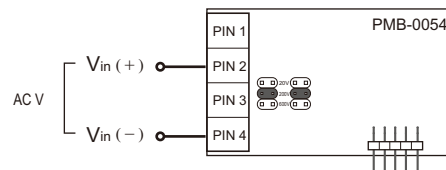

B6: 600V AC Scaled RMS

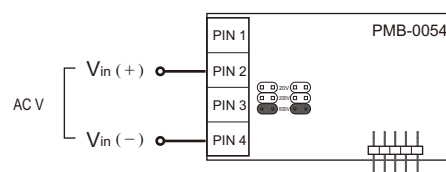

PM DC SIGNAL INPUT MODULE

This section will elaborate how to adapt to different input signals in the PM series panel meter, by using the correct jumper and using iSEL command. Panel meter series can accommodate 6 types of conventional input signals, 20mA, 200mA, 5V, 10V, 20V, 200V, please refer below for setup.

Single Channel Signal Input Module: (For PM-1430)

C1: 2mA DC with Excitation +24V

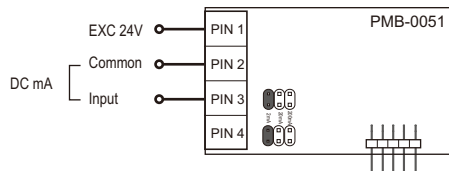

D1: 20 mV DC with Excitation +24V

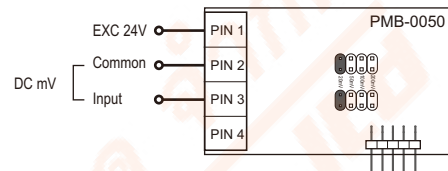

C2: 20mA DC with Excitation +24V

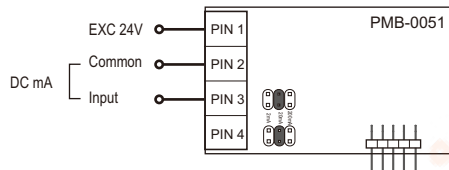

D2: 50 mV DC with Excitation +24V

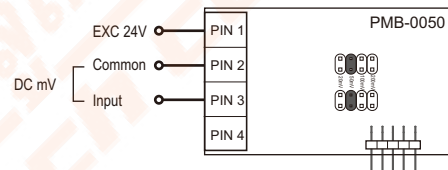

C3: 200mA DC with Excitation +24V

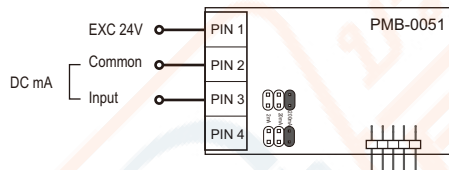

D3: 100 mV DC with Excitation +24V

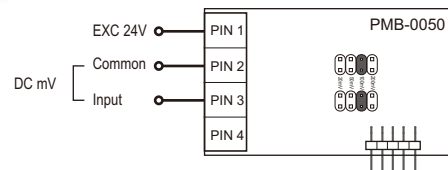

C4: 1A DC

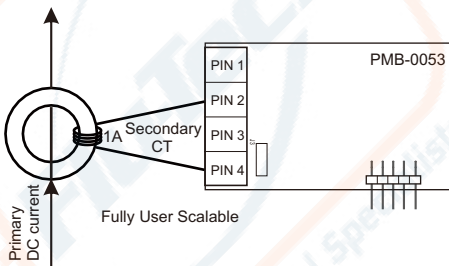

D4: 200 mV DC with Excitation +24V

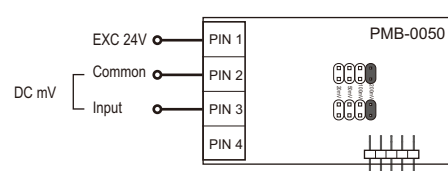

C5: 5A DC

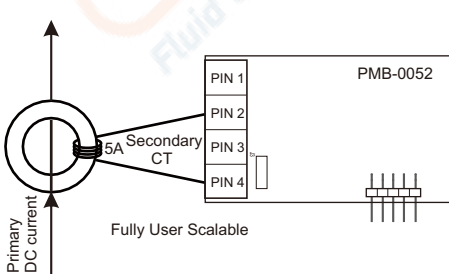

TEMPERATURE CONTROLLER INTRODUCTION

PRODUCT INTRODUCTION

The 76 series programmable temperature controller is FineTek's high-end controller. Equipped with a 14 bit analog/ digital converter core processor and with FUZZY and improved PID calculation microprocessor, the controller is capable of fast and accurate performance with reliable results. Double row of 4 digit displays indicates Present Value and Set Value (except PT7610), enables user friendly readings and coupled with 3 buttons operation, it makes operating the controller very convenient.

High Sampling Rate, High Accuracy

Sampling rate of 4 times per second (equivalent to 0.25sec per sampling) enables the controller to achieve high accuracy readings and accurate operations.

PID + FUZZY Control

Addition of FUZZY technology to PID control enables the controller to use the shortest time required as well as the smallest transients in order to achieve stability at the set value required by the user.

Auto-tuning

Artificial intelligence technology enables the controller to calculate the most efficient parameters to suit each and every application, thereby increasing the efficiency of the process to the maximum.

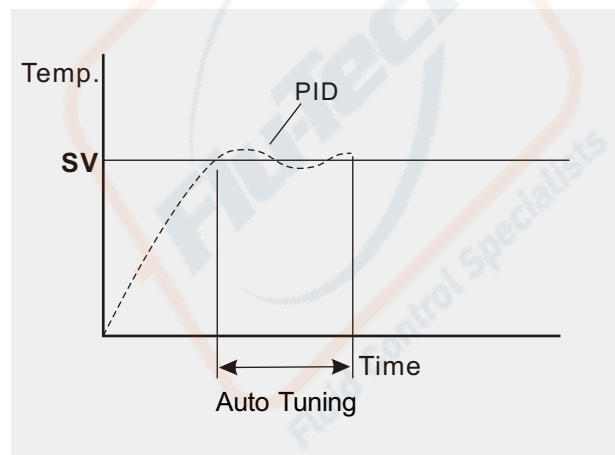

Sensor Break Alarm:

If the temperature sensor malfunctions / breaks, an alarm figure will be displayed on the panel to notify users.



PT-7610
(48x24)



PT-7620
(48x48)

Lock Protection for Control Parameters

Provides 3 levels of lock protection available should the user choose to lock the parameters in case of parameters change by accident.

Heating / Cooling Bi-directional Control

Enables the user to select between both heating and cooling processes, reduces inconveniences of single direction control methodology and reduces inventory.

Universal Input

Support the input signal of industry measurement, program setting through software, facility in installation and operation.

Switching Power Supply

Accepts 100 ~ 240VAC, 50/60Hz power supply, able to prevent controller from being affected by interferences due to ripples in power supply.

RS485 (Modbus) Communication:

Both RTU and ASCII communication modes for selection

SPECIFICATIONS

CONTROL FUNCTION

Control Method	ON/OFF, PID+Auto Tuning, PID+Auto Tuning+Fuzzy
Fraction Value	0~9999
Integral time	0~9999
Differential time	0~9999
Alarm / Output Hysteresis setting	0~9999
Sampling Interval	0.25s
Output Control Cycle	0.1~999.9s

ALARM FUNCTION

Alarm Types	Absolute Value Alarm, Discrepancy Alarm, Area Alarm
Set Value	0~99s
Alarm Output	SPST- ON, 3A-250VAC (Resistance Load)
Action Method	Alarm Activation / De-Activation delay
Signal Output	Relay Output

SIGNAL INPUT

Signal Input	Range	Accuracy
Thermocouple	K Type	-200~1370°C ±0.3% ±1digit
	K Type	-128.0~500.0°C ±0.3% ±1digit
	J Type	-200~1200°C ±0.3% ±1digit
	J Type	-128.0~500.0°C ±0.3% ±1digit
	T Type	-200~400°C ±0.3% ±1digit
	T Type	-128.0~400.0°C ±0.3% ±1digit
	E Type	-200~800°C ±0.3% ±1digit
	R Type	0~1760°C ±0.3% ±1digit
	S Type	0~1760°C ±0.3% ±1digit
	B Type	0~1820°C ±0.3% ±1digit
	N Type	-200~1300°C ±0.3% ±1digit
RTD	PT Type	-200~850°C ±0.2% ±1digit
	PT Type	-199.9~850.0°C ±0.2% ±1digit
	JPT Type	-200~500°C ±0.2% ±1digit
	JPT Type	-199.9~500.0°C ±0.2% ±1digit
Direct Voltage	0~50mV	-1999~9999 ±0.3% ±1digit
	0~1V	-1999~9999 ±0.3% ±1digit
	0~5V	-1999~9999 ±0.3% ±1digit
	1~5V	-1999~9999 ±0.3% ±1digit
	0~10V	-1999~9999 ±0.3% ±1digit
	2~10V	-1999~9999 ±0.3% ±1digit
Direct Current	0~20mA	-1999~9999 ±0.3% ±1digit
	4~20mA	-1999~9999 ±0.3% ±1digit

≡ Accuracy ±8°C for R and S in 0~500°C range

≡ For 0~600°C range, it does not guarantee accuracy on B type.

MAIN CONTROL OUTPUT

Specifications / Model	7610	7620
Module		
Relay	SPST-ON 3A/250Vac	SPST-ON 3A/250Vac
Pulse Output (SSR)	0/12Vdc (NPN), Max.20 mA	
Analog (Re-transmission)	4~20 mA	
	0~10Vdc Min.600Ω	

2nd CONTROL OUTPUT

Specifications / Model	7610	7620
Module		
Relay		SPST-ON 3A/250Vac
Pulse Output (SSR)	0/12Vdc (NPN), Max.20 mA	
Analog (Re-transmission)	4~20 mA	
	0~10Vdc Min.600Ω	

STANDARD SPECIFICATIONS

Power Supply	100~240Vac, 50/60Hz
Power Consumption	7VA
Input Resistance	>1MΩ
Input Compensation	-1999~9999
Digital Filter	1~50 Times
International Standard	CE
Settings Range	-1999~9999

DISPLAY

4 digit of 7 segment display, Accuracy $\pm 0.3\% \pm 1$ digit

Digit Size \ Model	7610	7620
Display		
PV (red)	0.31"	0.36"
SV (green)		0.28"

LED Indicators

Digit Size \ Model	7610	7620
Display		
Control Output	X 1	X 2
Alarm Output	X 1	X 1
Celsius Display	X 1	X 1
Fahrenheit Display	X 1	

BREAKOUT PROTECTION

Memory Retention	EEPROM
------------------	--------

OPERATING & STORAGE ENVIRONMENT

Operation Temperature	0~50°C
Operation Humidity	20~85%RH
Storage Temperature	-20°~60°C

STRUCTURE

Installation	Panel Mounted using 2 locking clips	
Casing Material	Plastic	
Dimensions	Refer to page 19	
Colour	Black	
Protection Rating	7610	7620
	IP-54	IP-65

COMMUNICATIONS

Communication Interface	RS-485
Communication Protocol	Modbus RTU or ASCII
Data Format	8 bits, Bit check: odd/even/none. Stop Bit: 1 or 2bits
Communication Speed	600, 1200, 2400, 4800, 9600, 19200 bps
Address	1~255

OTHER FUNCTIONS

Temperature Sensor Break Detection	Error display on panel
Parameters Lock	3 tier protection
1 st Tier	Adjustable: Input signal, alarm setpoint, set values, control type (All parameters)
2 nd Tier	Adjustable: alarm setpoint, set values, control type (Auto-tuning)
3 rd Tier	Fully lock

DIMENSION / PANEL CUTOUT & WIRING DIAGRAM

DIMENSION / PANEL CUTOUT & WIRING DIAGRAM

PT-7610:48mm(W) x 24mm(H) x 98.5mm(D)

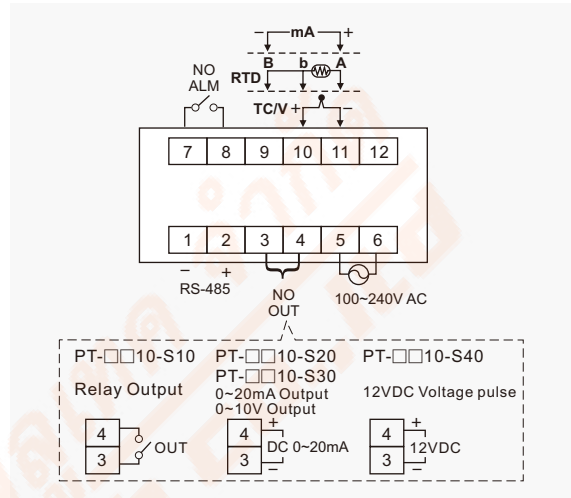
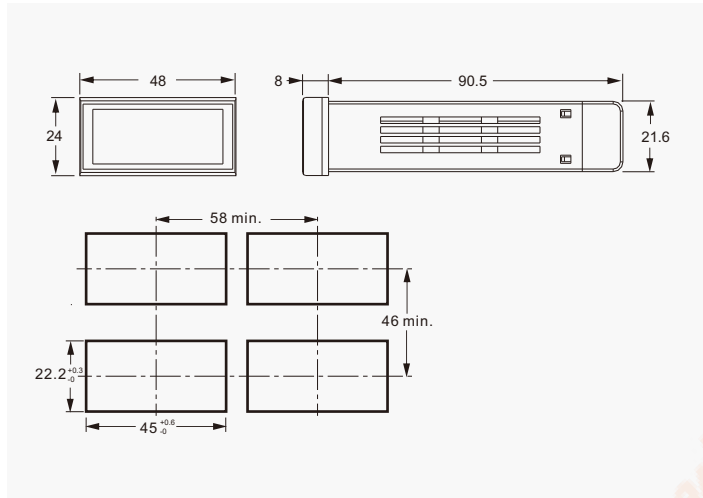

PT-7620:48mm(W) x 48mm(H) x 101mm(D)

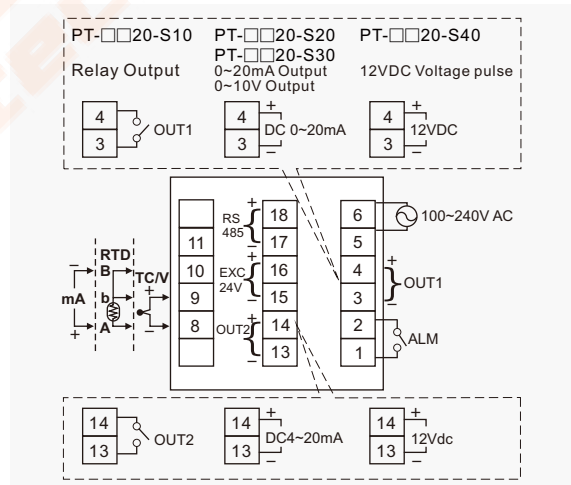
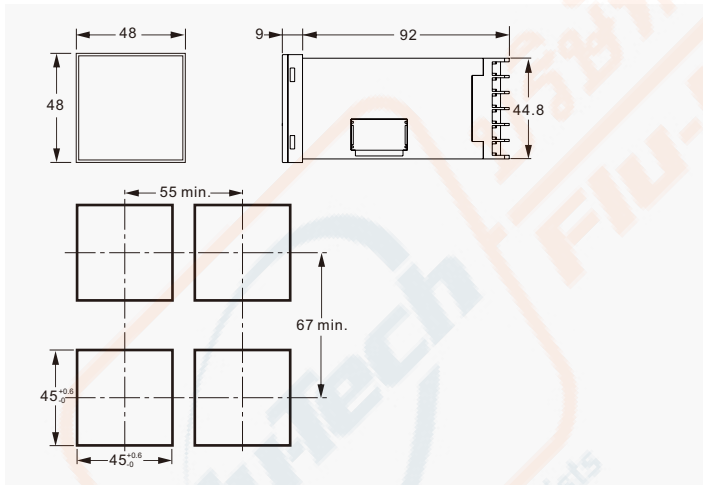

MODEL NUMBER / ORDER CODE COMPARISON TABLE

Model Number	Order Code
PT-7610	SFX10000-F
PT-7620	SFX10000-A



ORDER INFORMATION

PTX1 0 0 0 0 -

⑨ **Model**

- A: 48x48
- F: 48x24

⑩ **Power supply**

- A: 100~240Vac, 50/60Hz
- B: 20~36Vdc

⑪ **Output 1**

- | | |
|--|--------------------------------|
| 0: None | E: 4-20mA DC analog retransmit |
| A: Relay control output | F: 0-10V DC analog retransmit |
| B: 4-20mA DC control output | G: 2-10V DC analog retransmit |
| C: 0-10V DC control output | H: 0-5V DC analog retransmit |
| D: Voltage pulse (12Vdc) for SSR drive | I: 1-5V DC analog retransmit |

⑫ **Output 2**

- | | |
|--|--------------------------------|
| 0: None | E: 4-20mA DC analog retransmit |
| A: Relay control | F: 0-10V DC analog retransmit |
| B: 4-20mA DC control output | G: 2-10V DC analog retransmit |
| C: 0-10V DC control output | H: 0-5V DC analog retransmit |
| D: Voltage pulse (12Vdc) for SSR drive | I: 1-5V DC analog retransmit |

⑬ **Alarm output**

- 0: None
- A: 1 Set
- B: 2 Set

⑭ **Communication**

- 0: None
- A: RS-485

⑮ **Auxiliary power**

- 0: None
- A: 24VDC/50mA

⑯ **Terminal protector**

- 0: None
- C: Requested

