



AIR PREPARATION PRESSURE REGULATORS



ROSS CONTROLS

PRESSURE REGULATORS – KEY FEATURES

- Two design options available:
Piston design for highest air flow
Diaphragm design for high sensitivity and quick response
- Modular or In-line Mounting options
- Pressure Gauge included
- Removable Adjusting Knob for tamper resistance
- Self-relieving or non-relieving options
- Reverse Flow option available on some regulator models
- T-Handle option available on some regulator models

REGULATOR TYPE/SERIES	AVAILABLE PORT SIZES											MOUNTING		FLOW	CONSTRUCTION		OPTIONS					Page
	1/8	1/4	3/8	1/2	3/4	1	1¼	1½	2	3	IN-LINE	MODULAR	MAX FLOW (scfm)	PISTON	DIAPHRAGM	SELF RELIEVING	NON RELIEVING	REVERSE FLOW	T-HANDLE	LOCKING KNOB		
STANDARD REGULATORS																						
RIGHT-ANGLE													55									G2.3
BANTAM													23									G2.4
MINIATURE													40									G2.5
MID-SIZE													100									G2.6
MD3™													120									G2.7
FULL-SIZE													155									G2.8
MD4™													220									G2.9
HIGH-CAPACITY													800									G2.10
HIGH-PRESSURE REGULATORS																						
HIGH-PRESSURE													70									G2.11
PRECISION REGULATORS																						
MINIATURE													4									G2.12
FULL-SIZE													155									G2.13
MD4™													170									G2.14
HIGH-CAPACITY													800									G2.15
REMOTE PILOT REGULATORS																						
FULL-SIZE													155									G2.16 - G2.18
MD4™													190									G2.19
HIGH-CAPACITY													4000									G2.20 - G2.23
RELIEF VALVES																						
MINIATURE													40									G2.24
HIGH-FLOW													450									G2.25
PROPORTIONAL VALVES																						
RER Series													1000									G2.26
RB-RER Series													4000									G2.27

In-line Pressure Regulators

RIGHT-ANGLE Series

Port Sizes: 1/8, 1/4, 3/8 & 1/2 – Flow to 55 scfm

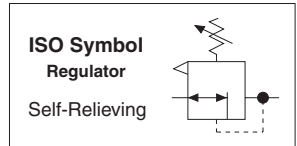

Models with Threaded Banjo						
Port Size		Port Threads	Model Number	Dimensions inches (mm)		Tightening Torque Max. Ft-lb (Nm)
Port 1 (female threads)	Port 2 (male threads)			A	B	
1/8	1/8	NPT	5214A1010	0.7 (17)	2.9 (74)	7.38 (10)
1/4	1/4	NPT	5214A2010	0.7 (17)	3.2 (81)	8.85 (12)
3/8	3/8	NPT	5214A3010	0.9 (22)	3.5 (88)	14.75 (20)
1/2	1/2	NPT	5214A4010	1.1 (27)	3.5 (89)	22.13 (30)
1/8	1/8	G	D5214A1010	0.7 (17)	2.9 (74)	11.06 (15)
1/4	1/4	G	D5214A2010	0.7 (17)	3.2 (81)	14.75 (20)
3/8	3/8	G	D5214A3010	0.9 (22)	3.5 (88)	22.13 (20)
1/2	1/2	G	D5214A4010	1.1 (27)	3.5 (89)	22.50 (30)

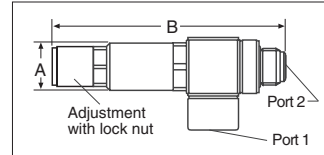

Models with Push-to-Connect Fitting					
Port Size		Valve Model Number	Dimensions inches (mm)		Tightening Torque Max. Ft-lb (Nm)
Port 1# (tube size)	Port 2** (thread size)		A	B	
1/4"	1/8 NPT	5214A1120	0.7 (17)	2.9 (73)	11.06 (15)
1/4"	1/4 NPT	5214A2120	0.7 (17)	3.2 (81)	14.75 (20)
3/8"	1/4 NPT	5214A2130	0.7 (17)	3.2 (81)	14.75 (20)
3/8"	3/8 NPT	5214A3130	0.9 (22)	3.5 (88)	22.13 (30)
4 mm	1/8 G	D5214A1140	0.5 (13)	2.9 (73)	7.38 (10)
6 mm	1/8 G	D5214A1160	0.5 (13)	2.9 (73)	7.38 (10)
8 mm	1/8 G	D5214A1180	0.5 (13)	2.9 (73)	7.38 (10)
6 mm	1/4 G	D5214A2160	0.7 (17)	3.2 (81)	8.85 (12)
8 mm	1/4 G	D5214A2180	0.7 (17)	3.2 (81)	8.85 (12)
10 mm	1/4 G	D5214A2110	0.7 (17)	3.2 (81)	8.85 (12)
8 mm	3/8 G	D5214A3180	0.9 (22)	3.5 (88)	14.75 (20)
10 mm	3/8 G	D5214A3110	0.9 (22)	3.5 (88)	14.75 (20)

Port 1 tubing size in inches (") or millimeters (mm). ** Port 2 threads are male.

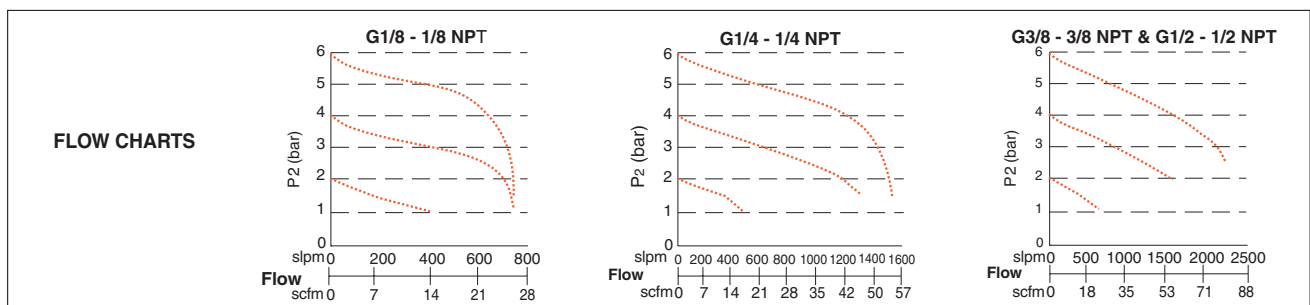
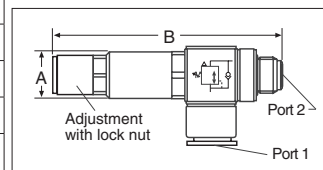

STANDARD SPECIFICATIONS (for regulators on this page):

Construction Design	Self-relieving	Operating Pressure	15 to 240 psig (1 to 17 bar)
Temperature	Ambient/Media: 15° to 160°F (-10° to 70°C)	Regulated Pressure Range:	15 to 120 psig (1 to 8 bar).
Fluid Media	Filtered air	Construction Material	Bowl: Metal

IMPORTANT NOTE: Please read carefully and thoroughly all of the **CAUTIONS, WARNINGS** on the inside back cover.



Online Version
02/01/21



www.rosscontrols.com

Modular Regulators

BANTAM Series

Port Sizes: 1/8, 1/4 & 3/8 – Flow to 23 scfm

Port Size	Piston			Diaphragm		
	Model Number			Model Number		
	Regulated Pressure psig (bar)			Regulated Pressure psig (bar)		
	0-50 (0-3.4)	0-100 (0-6.9)	0-125 (0-8.6)	0-50 (0-3.4)	0-100 (0-6.9)	0-125 (0-8.6)
With THREADED PORTS						
1/8 NPTF	5B01C0030	5B01C0010	5B01C0050	5B01C0040	5B01C0020	5B01C0060
1/8 G	C5B01C0030	C5B01C0010	C5B01C0050	C5B01C0040	C5B01C0020	C5B01C0060
1/4 NPTF	5B02C0030	5B02C0010	5B02C0050	5B02C0040	5B02C0020	5B02C0060
1/4 G	C5B02C0030	C5B02C0010	C5B02C0050	C5B02C0040	C5B02C0020	C5B02C0060
With Quick Connect TUBE FITTINGS						
1/4	5B03C0030	5B03C0010	5B03C0050	5B03C0040	5B03C0020	5B03C0060
3/8	5B04C0030	5B04C0010	5B04C0050	5B04C0040	5B04C0020	5B04C0060
4mm	5B05C0030	5B05C0010	5B05C0050	5B05C0040	5B05C0020	5B05C0060
6mm	5B06C0030	5B06C0010	5B06C0050	5B06C0040	5B06C0020	5B06C0060
8mm	5B07C0030	5B07C0010	5B07C0050	5B07C0040	5B07C0020	5B07C0060
10mm	5B08C0030	5B08C0010	5B08C0050	5B08C0040	5B08C0020	5B08C0060

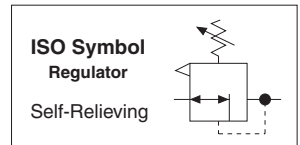

Port Size	Dimensions inches (mm)				Weight lb (kg)
	A	B	C	Depth*	
No Port	1.7 (43)	2.6 (67)	0.5 (13)	1.8 (45)	0.21 (0.09)
1/8, 1/4 (NPT or G)	3.0 (76)	2.6 (67)	0.5 (13)	1.8 (45)	0.43 (0.19)
<i>Models below have quick-connect tube fittings.</i>					
1/4	3.4 (86)	2.6 (67)	0.5 (13)	1.8 (45)	0.21 (0.09)
3/8	3.9 (99)	2.6 (67)	0.5 (13)	1.8 (45)	0.21 (0.09)
4 mm	3.4 (86)	2.6 (67)	0.5 (13)	1.8 (45)	0.41 (0.18)
6 mm	3.4 (86)	2.6 (67)	0.5 (13)	1.8 (45)	0.41 (0.18)
8 mm	3.1 (79)	2.6 (67)	0.5 (13)	1.8 (45)	0.41 (0.18)
10 mm	3.9 (99)	2.6 (67)	0.5 (13)	1.8 (45)	0.41 (0.18)

* Less gauge.

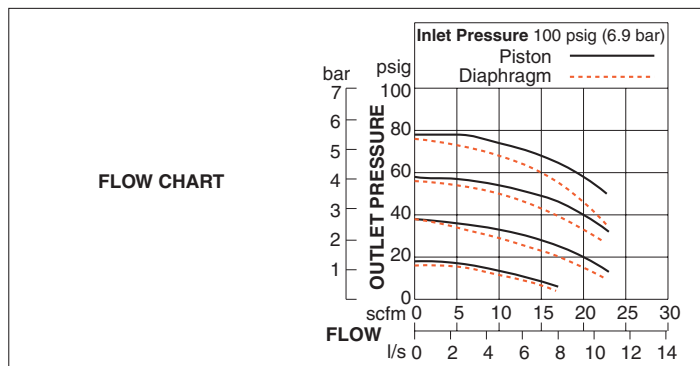
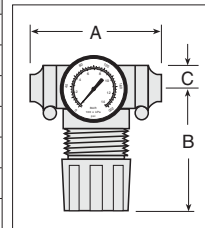

Pressure Gauge included.
Accessories ordered separately, refer to page G6.3-4.

STANDARD SPECIFICATIONS (for regulators on this page):

Construction Design	Piston or Diaphragm Self-relieving; For non-relieving option consult ROSS.	Pressure Gauge	0 to 160 psig (0 to 11 bar); 1/8 gauge ports front and rear
Temperature	Ambient/Media: 40° to 125°F (4° to 52°C)	Panel Mounting	1-3/16 inch (30 mm) hole required
Fluid Media	Compressed air	Construction Material	Body: Acetal
Operating Pressure	Inlet: Maximum 150 psig (10 bar) Outlet: Adjustable up to 100 psig (7 bar)		Dome and Knob: Acetal
			Seals: Nitrile

IMPORTANT NOTE: Please read carefully and thoroughly all of the **CAUTIONS, WARNINGS** on the inside back cover.

Port Sizes: 1/8 & 1/4 – Flow to 40 scfm

Port Size	Port Threads	Piston			Diaphragm		
		Model Number			Model Number		
		Regulated Pressure psig (bar)			Regulated Pressure psig (bar)		
		0-50 (0-3.4)	0-100 (0-6.9)	0-125 (0-8.6)	0-50 (0-3.4)	0-100 (0-6.9)	0-125 (0-8.6)
1/8	NPTF	5212C1004	5211C1004	5213C1004	5212C1005	5211C1005	5213C1005
	G	C5212C1004	C5211C1004	C5213C1004	C5212C1005	C5211C1005	C5213C1005
1/4	NPTF	5212C2004	5211C2004	5213C2004	5212C2005	5211C2005	5213C2005
	G	C5212C2004	C5211C2004	C5213C2004	C5212C2005	C5211C2005	C5213C2005



Port Size	Dimensions inches (mm)				Weight* lb (kg)
	A	B	C	Depth*	
1/8, 1/4	1.6 (41)	2.7 (68)	0.4 (10)	1.6 (41)	0.24 (0.11)

* Less gauge.

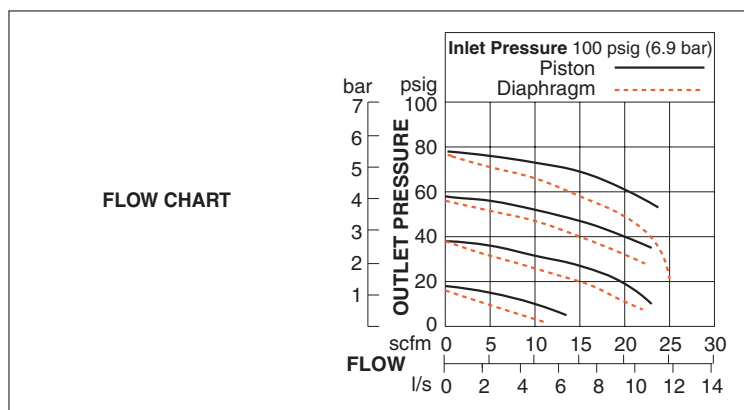
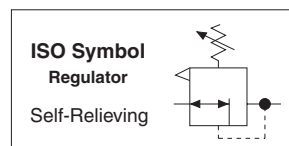
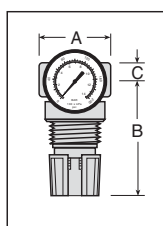

Pressure Gauge included.
Accessories ordered separately, refer to page G6.3-4.

STANDARD SPECIFICATIONS (for regulators on this page):

Construction Design	Piston or Diaphragm Self-relieving; For non-relieving option consult ROSS.	Pressure Gauge	0 to 160 psig (0 to 11 bar); 1/8 gauge ports front and rear
Temperature	Ambient/Media: 40° to 125°F (4° to 52°C)	Panel Mounting	1-3/16 inch (30 mm) hole required
Fluid Media	Compressed air	Construction Material	Body: Aluminum
Operating Pressure	Inlet: Maximum 300 psig (21 bar) Outlet: Adjustable up to 100 psig (7 bar)		Dome and Knob: Acetal
			Seals: Nitrile

IMPORTANT NOTE: Please read carefully and thoroughly all of the **CAUTIONS, WARNINGS** on the inside back cover.

Port Sizes: 1/4, 3/8 & 1/2 – Flow to 100 scfm

Port Size	Pressure Range psig (bar)					
	0-50 (0-3.4)		0-100 (0-6.9)		0-150 (0-10.3)	
	Model Number		Model Number		Model Number	
	NPTF Threads	G Threads	NPTF Threads	G Threads	NPTF Threads	G Threads
1/4	5212B2015	C5212B2015	5211B2015	C5211B2015	5213B2015	C5213B2015
3/8	5212B3015	C5212B3015	5211B3015	C5211B3015	5213B3015	C5213B3015
1/2	5212B4015	C5212B4015	5211B4015	C5211B4015	5213B4015	C5213B4015



REGULATORS with REVERSE FLOW					
Port Size	Regulated Pressure Range psig (bar)	Pressure Adjustment			
		Knob		T-Handle	
		Model Numbers		Model Numbers	
		NPTF Threads	BSPP Threads	NPTF Threads	BSPP Threads
1/4	0-100 (0-6.9)	5X00B2035	C5X00B2035	5X00B2039	C5X00B2039
3/8	0-100 (0-6.9)	5X00B3024	C5X00B3024	5X00B3021	C5X00B3021
1/2	0-100 (0-6.9)	5X00B4023	C5X00B4023	5X00B4041	C5X00B4041

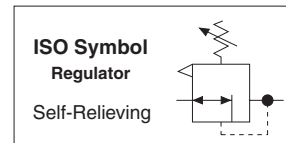

Port Size	Dimensions inches (mm)				Weight* lb (kg)
	A	B	C	Depth*	
1/4, 3/8, 1/2	2.7 (68)	3.3 (83)	1.3 (33)	2.1 (52)	1.0 (0.46)

*Less gauge.

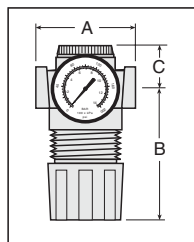

Reverse-Flow Regulators provide regulated in-to-out pressure control, plus quick exhausting from out-to-in. Used for downstream pressure regulation of weld guns and other applications requiring quick exhausting through the regulator.

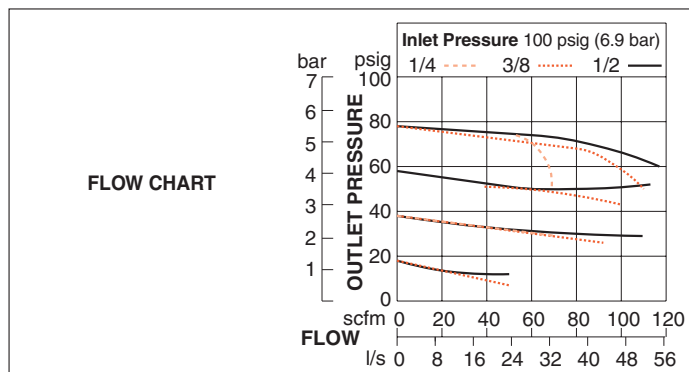

Pressure Gauge included.
Accessories ordered separately, refer to page G6.3-4.

STANDARD SPECIFICATIONS (for regulators on this page):

Construction Design	Piston or Diaphragm Self-relieving; For non-relieving option consult ROSS.	Panel Mounting	1-9/16 inch (40 mm) hole required
Temperature	Ambient/Media: 40° to 125°F (4° to 52°C)	Construction Material	Body: Zinc
Fluid Media	Compressed air		Cap: Nylon
Operating Pressure	Inlet: Maximum 250 psig (17 bar) Outlet: Adjustable up to 150 psig (10 bar)		Dome: Acetal
Pressure Gauge	0 to 200 psig (0 to 14 bar); 1/4 NPT gauge ports front and rear		Knob: Acetal
			Seals: Nitrile

IMPORTANT NOTE: Please read carefully and thoroughly all of the **CAUTIONS, WARNINGS** on the inside back cover.

Port Sizes: 1/4, 3/8 & 1/2 – Flow to 120 scfm



Choose your options (in red) to configure your model number.

MD3 **52K** **A** **R** **C** **2** **2** **A**

ADJUSTMENT TYPE	
Knob	52K
Tee Handle	52T
Locking Knob	52L

ADJUSTMENT RANGE	
0-200 psig (0-13.8 bar)	A
0-150 psig (0-10.3 bar)	B
0-100 psig (0-6.9 bar)	C
0-50 psig (0-3.4 bar)	D

PIPE SIZE	
1/4 NPTF	2
3/8 NPTF	3
1/2 NPTF	4
1/4 G	B
3/8 G	C
1/2 G	D

FLOW OPTIONS	
Reverse Flow	R
Standard Flow	S

GAUGE	
Without Gauge	A
Gauge 0-200 psig (0-13.8 bar)	B
Gauge 0-60 psig (0-4.1 bar)	C
Without Gauge, with Panel Mount Nut	D
Gauge 0-200 psig (0-13.8 bar), with Panel Mount Nut	E
Gauge 0-60 psig (0-4.1 bar), with Panel Mount Nut	F

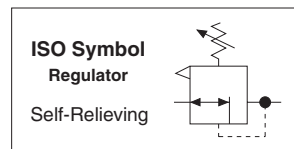

Port Size	Dimensions inches (mm)				Weight† lb (kg)
	A	B*	C**	Depth†	
1/4, 3/8, 1/2, 3/4	3.0 (76.2)	4.52 (114.9)	1.46 (37)	2.51 (63.8)	1.9 (0.86)

* Dome removal clearance: add 0.575 (14.6).
** Cap removal clearance: add 0.750 (19.1).
† Less gauge.

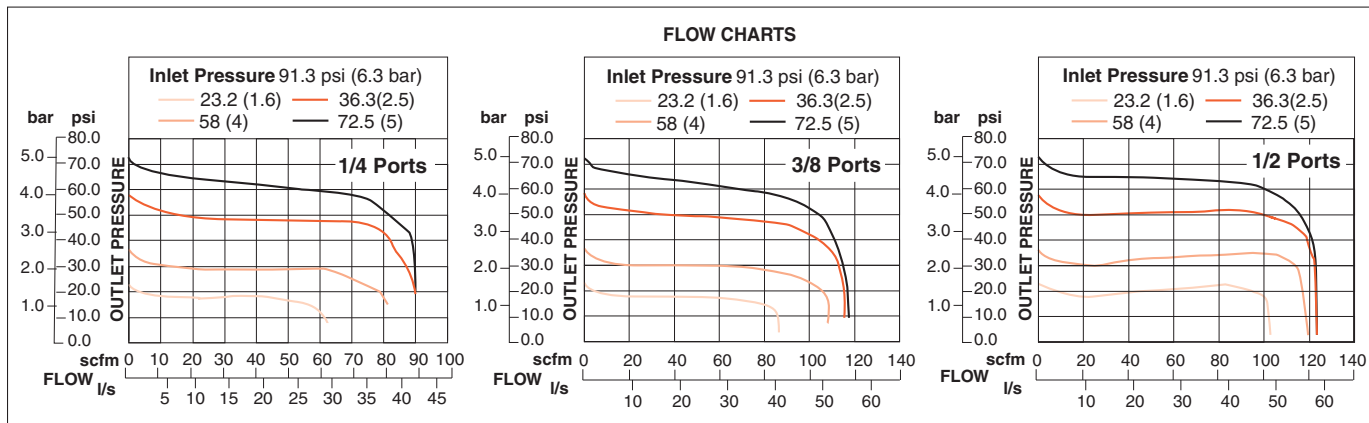

Accessories ordered separately, refer to page G6.3-5.

STANDARD SPECIFICATIONS (for regulators on this page):

Construction Design	Diaphragm Self-relieving; For non-relieving option consult ROSS.	Panel Mounting	2-1/16 inch (52 mm) hole required
Temperature	Ambient/Media: 40° to 175°F (4° to 79°C)	Construction Material	Body: Zinc
Fluid Media	Compressed air		Dome: Nylon
Operating Pressure	Inlet: Maximum 300 psig (21 bar) Outlet: Adjustable up to 200 psig (14 bar); optional adjusting springs.		Knob: Acetal
Optional Pressure Adjustment	Locking Key: Removable		Seals: Nitrile
Pressure Gauge	0-200 psig (0-14 bar) or 0-60 psig (0-4 bar); 1/4-NPT gauge ports front and rear		Valve: Brass Valve Cap: Nylon

IMPORTANT NOTE: Please read carefully and thoroughly all of the **CAUTIONS, WARNINGS** on the inside back cover.



Modular Regulators

FULL-SIZE Series

Port Sizes: 1/4, 3/8, 1/2 & 3/4 – Flow to 155 scfm

Port Size	Pressure Range psig (bar)					
	0-50 (0-3.4)		0-125 (0-8.6)		0-175 (0-12.1)	
	Model Number		Model Number		Model Number	
	NPTF Threads	G Threads	NPTF Threads	G Threads	NPTF Threads	G Threads
1/4	5212B2017	C5212B2017	5211B2017	C5211B2017	5213B2017	C5213B2017
3/8	5212B3017	C5212B3017	5211B3017	C5211B3017	5213B3017	C5213B3017
1/2	5212B4017	C5212B4017	5211B4017	C5211B4017	5213B4017	C5213B4017
3/4	5212B5027	C5212B5027	5211B5027	C5211B5027	5213B5027	C5213B5027



REGULATORS with REVERSE FLOW					
Port Size	Pressure Adjustment 0-125 (0-8.6)				
	Knob		T-Handle		
	Model Number		Model Number		
	NPT Threads	G Threads	NPT Threads	G Threads	G Threads
1/4	5X00B2010	C5X00B2010	–	–	–
3/8	5X00B3004	C5X00B3004	5X00B3012	C5X00B3012	C5X00B3012
1/2	5X00B4004	C5X00B4004	5X00B4047	C5X00B4047	C5X00B4047
3/4	5X00B5034	C5X00B5034	5X00B5044	C5X00B5044	C5X00B5044

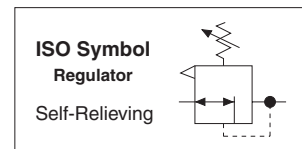

Port Size	Dimensions inches (mm)				Weight † lb (kg)
	A	B**	C***	Depth †	
1/4, 3/8, 1/2, 3/4	3.5 (89)	5.8 (146)	1.3 (33)	2.8 (71)	2.06 (0.92)

** Dome removal clearance: add 0.63 (16).
 *** Cap removal clearance: add 0.5 (13).
 † Less gauge.

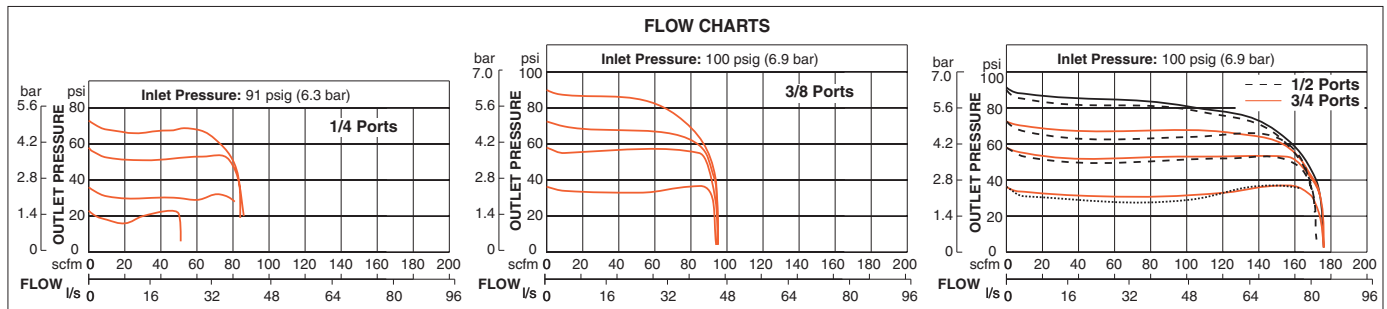

Pressure Gauge included.
Accessories ordered separately, refer to page G6.3-4.

STANDARD SPECIFICATIONS (for regulators on this page):

Construction Design	Diaphragm Self-relieving; For non-relieving option consult ROSS.	Panel Mounting	2-1/16 inch (52 mm) hole required
Temperature	Ambient/Media: 40° to 175°F (4° to 79°C)	Construction Material	Body: Zinc
Fluid Media	Compressed air		Dome: Nylon; aluminum with optional 0 to 175 psig (0 to 12 bar) spring
Operating Pressure	Inlet: Maximum 300 psig (21 bar) Outlet: Adjustable up to 175 psig (12 bar); optional adjusting springs.		Knob: Acetal
Optional Pressure Adjustment	Locking Key: Removable		Seals: Nitrile
Pressure Gauge	0-200 psig (0-14 bar); 1/4-NPT gauge ports front and rear		Valve: Brass Valve Cap: Nylon

IMPORTANT NOTE: Please read carefully and thoroughly all of the **CAUTIONS, WARNINGS** on the inside back cover.

Port Sizes: 3/8, 1/2 & 3/4 – Flow to 220 scfm

HOW TO ORDER

Choose your options (in red) to configure your model number.

MD4 **52K** **A** **S** **B** **5** **2** **B**

ADJUSTMENT TYPE	
Knob	52K
Tee Handle	52T

ADJUSTMENT RANGE	
0-175 psig (0-12.1 bar)	A
0-125 psig (0-8.6 bar)	B
0-50 psig (0-3.4 bar)	C
0-20 psig (0-1.4 bar)	D

PIPE SIZE	
3/8 NPTF	3
1/2 NPTF	4
3/4 NPTF	5
3/8 G	C
1/2 G	D
3/4 G	E

FLOW OPTIONS	
Reverse Flow	R
Standard Flow	S

CAP COLOR	
Black	2
Yellow	Y

GAUGE	
Without Gauge	A
Gauge 0-200 psig (0-13.8 bar)	B
Gauge 0-60 psig (0-4.1 bar)	C
Without Gauge, with Panel Mount Nut	D
Gauge 0-200 psig (0-13.8 bar), with Panel Mount Nut	E
Gauge 0-60 psig (0-4.1 bar), with Panel Mount Nut	F



ISO Symbol
Regulator
Self-Relieving

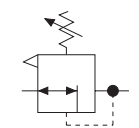

Port Size	Dimensions inches (mm)				Weight † lb (kg)
	A	B*	C**	Depth †	
3/8, 1/2, 3/4	3.5 (87)	5.6 (142)	1.6 (40)	2.9 (73)	2.56 (1.16)

*Dome removal clearance: add 0.625 (16).
 **Cap removal clearance: add 0.50 (13).
 † Dimensions reflect less gauge.

FLOW CHARTS

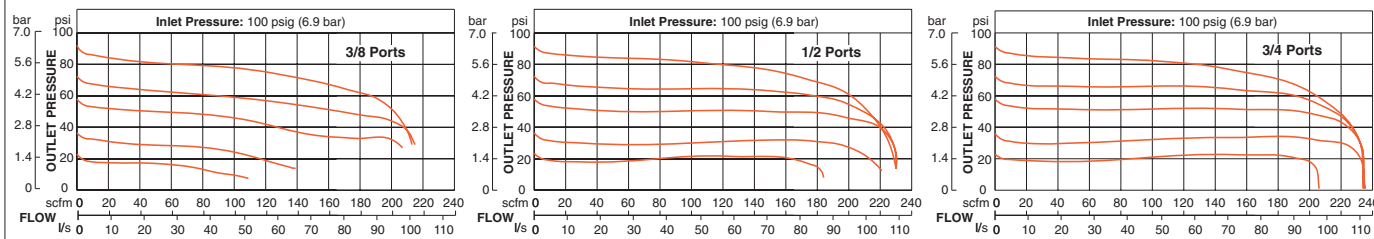

Accessories ordered separately, refer to page G6.3-5.

STANDARD SPECIFICATIONS (for regulators on this page):

Construction Design	Diaphragm Self-relieving; For non-relieving option consult ROSS.	Panel Mounting	2-1/16 inch (52 mm) hole required
Temperature	Ambient/Media: 40° to 175°F (4° to 79°C)	Construction Material	Body: Zinc
Fluid Media	Compressed air		Dome: Nylon; aluminum with optional 0 to 175 psig (0 to 12 bar) spring
Operating Pressure	Inlet: Maximum 300 psig (21 bar) Outlet: Adjustable up to 175 psig (12 bar); optional adjusting springs.		Knob: Acetal
Optional Pressure Adjustment	Locking Key: Removable		Seals: Nitrile
Pressure Gauge	0-200 psig (0-14 bar); 1/4-NPT gauge ports front and rear		Valve: Brass
		Valve Cap: Nylon	

IMPORTANT NOTE: Please read carefully and thoroughly all of the **CAUTIONS, WARNINGS** on the inside back cover.



In-line Regulators

HIGH-CAPACITY Series

Port Sizes: 3/4, 1, 1¼ & 1½ – Flow to 800 scfm

Port Size	Pressure Range psig (bar)			
	0-50 (0-3.4)		0-100 (0-6.9)	
	Model Number		Model Number	
	NPTF Threads	G Threads	NPTF Threads	G Threads
3/4	5212D5017	C5212D5017	5211D5017	C5211D5017
1	5212D6017	C5212D6017	5211D6017	C5211D6017
1¼	5212C7017	C5212C7017	5211C7017	C5211C7017
1½	5212C8017	C5212C8017	5211C8017	C5211C8017



REGULATORS with REVERSE FLOW:					
Port Size	Pressure Range psig (bar)	Pressure Adjustment			
		Knob		T-Handle	
		Model Number		Model Number	
		NPTF Threads	G Threads	NPTF Threads	G Threads
3/4	0-100 (0-6.9)	5X00B5049	C5X00B5049	5X00B5050	C5X00B5050
1	0-100 (0-6.9)	5X00D6003	C5X00D6003	5X00B6038	C5X00B6038
1¼	0-100 (0-6.9)	5X00C7003	C5X00C7003	5X00B7016	C5X00B7016
1½	0-100 (0-6.9)	5X00C8001	C5X00C8001	5X00B8024	C5X00B8024

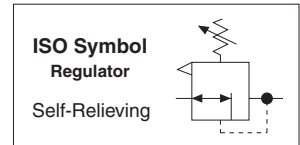

Port Size	Dimensions inches (mm)				Weight † lb (kg)
	A	B**	C***	Depth †	
3/4, 1	4.4 (111)	6.1 (154)	2.4 (62)	2.8 (71)	2.19 (0.99)
1¼, 1½	4.9 (124)	6.4 (162)	2.1 (54)	2.8 (71)	2.50 (1.14)

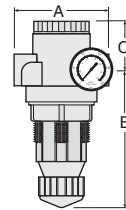

** Dome removal clearance: add 0.63 (16).
 *** Cap removal clearance: add 0.65 (16.5).
 † Dimensions reflect less gauge.

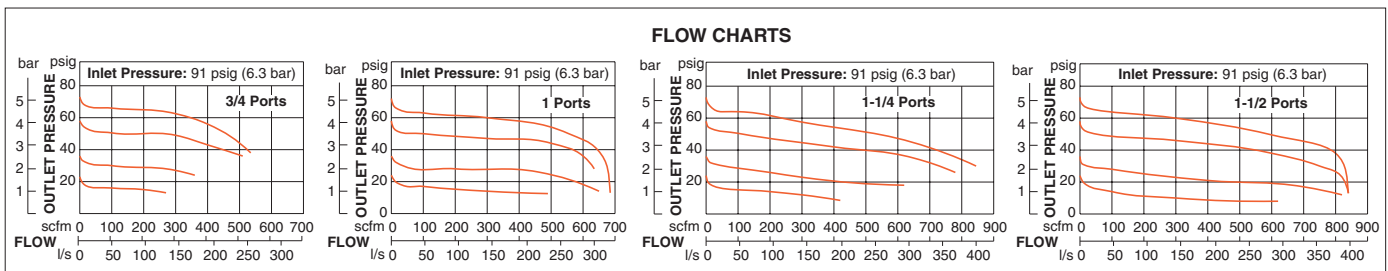

Pressure Gauge included.
Accessories ordered separately, refer to page G6.3-4.

STANDARD SPECIFICATIONS (for regulators on this page):

Construction Design	Piston Self-relieving	Construction Material	Body: Aluminum
Temperature	Ambient/Media: 40° to 175°F (4° to 79°C)		Dome: Nylon; aluminum with optional 0 to 150 psig (0 to 10 bar) spring
Fluid Media	Compressed air		Knob: Acetal
Operating Pressure	Inlet: Maximum 300 psig (21 bar) Outlet: Adjustable up to 100 psig (7 bar)		Seals: Nitrile
Optional Pressure Adjustment	Locking Key: Removable		Valve: Brass
Pressure Gauge	0-200 psig (0-14 bar); 1/4-NPT gauge ports front and rear		Valve Cap: Nylon
Panel Mounting	2-1/16 inch (52 mm) hole required		

IMPORTANT NOTE: Please read carefully and thoroughly all of the **CAUTIONS, WARNINGS** on the inside back cover.

In-line High-Pressure Regulators

HIGH-PRESSURE Series

Port Sizes: 1/8, 1/4 & 3/8 – Flow to 70 scfm

Port Size	Piston Type			
	Relieving		Non-Relieving	
	Model Number		Model Number	
	NPTF Threads	G Threads	NPTF Threads	G Threads
1/8	5215B1004	C5215B1004	5X00B1025	C5X00B1025
1/4	5215B2004	C5215B2004	5X00B2076	C5X00B2076
3/8	5215B3004	C5215B3004	5X00B3052	C5X00B3052



Port Size	Dimensions inches (mm)				Weight** lb (kg)
	A	B	C	Depth**	
1/8, 1/4	1.9 (47)	7.3 (186) max	0.4 (10)	1.9 (47)	1.15 (0.53)
3/8	2.1 (54)	7.4 (188) max	0.5 (13)	2.1 (54)	1.30 (0.59)

** Less gauge.

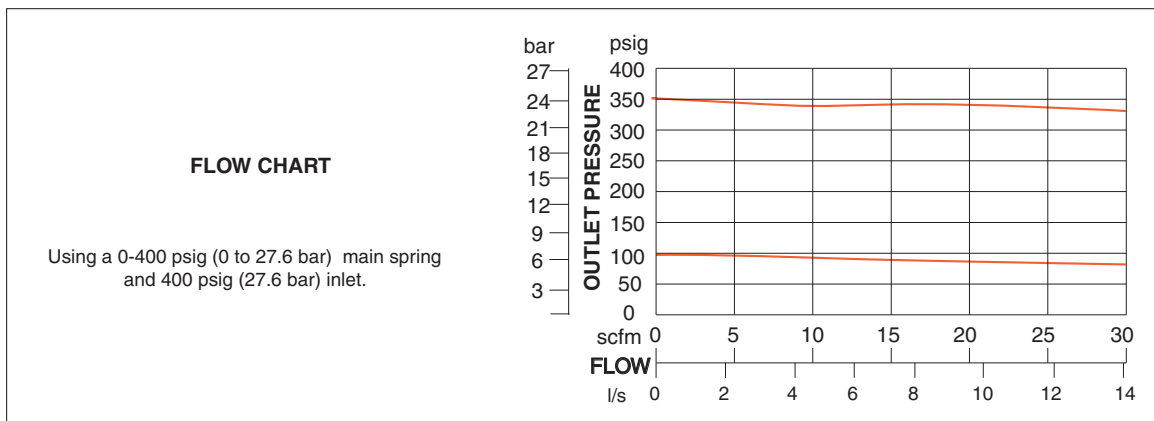
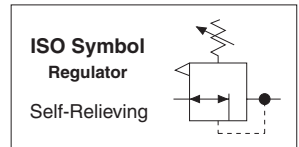
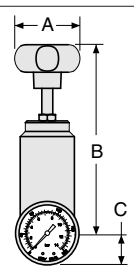

Pressure Gauge included.
Accessories ordered separately, refer to page G6.3-4.

STANDARD SPECIFICATIONS (for regulators on this page):

Construction Design	Piston Self-relieving, Non-relieving	Maximum Flow Rate	70 scfm (33.0 l/s) @400 psi (28 bar)
Temperature	Ambient/Media: 40° to 175°F (4° to 79°C)	Construction Material	Body: Aluminum
Fluid Media	Compressed air		Dome: Aluminum
Operating Pressure	Inlet: Maximum 400 psig (28 bar) Outlet: Adjustable up to 390 psig (27 bar)		Knob: Nylon
Pressure Gauge	0-600 psig (0-40 bar)		Seals: Fluoroelastomer
			Valve: Brass Valve Cap: Nylon

IMPORTANT NOTE: Please read carefully and thoroughly all of the **CAUTIONS, WARNINGS** on the inside back cover.



Online Version
02/01/21



www.rosscontrols.com

G2.11

In-line Precision Regulators

MINIATURE Series

Port Sizes: 1/8 & 1/4 – Flow to 4 scfm

Port Size	Regulated Pressure Range# psig (bar)	Model Number	
		NPTF Threads	G Threads
1/8	0-50 (0-3.4)	5212C1006	C5212C1006
1/4	0-50 (0-3.4)	5212C2006	C5212C2006

For 0-10 psig (0-0.7 bar), 0-20 psig (0-1.4 bar), and 0-60 psig (0-4.1 bar) ranges, consult ROSS.



Port Size	Dimensions inches (mm)				Weight** lb (kg)
	A	B	C	Depth**	
1/8, 1/4	1.8 (44)	3.4 (86)	0.4 (10)	1.8 (44)	0.38 (0.16)

**Less gauge.

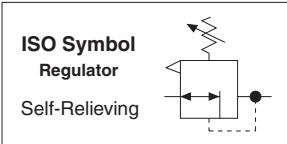
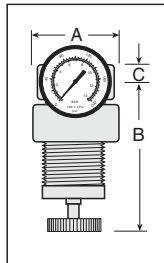

Precision Regulators have a small valve seat and a large diaphragm area, a combination that allows greater precision, sensitivity, adjustment resolution, and less variation in regulated pressure.

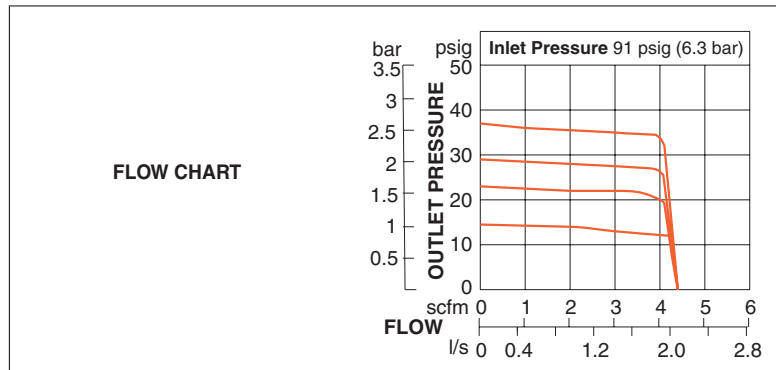

Accessories ordered separately, refer to page G6.3-4.

STANDARD SPECIFICATIONS (for regulators on this page):

Construction Design	Diaphragm Self-relieving	Panel Mounting	1-3/16 inch (30 mm) hole required
Temperature	Ambient/Media: 40° to 125°F (4° to 52°C)	Construction Material	Body: Aluminum
Fluid Media	Compressed air		Dome: Acetal
Operating Pressure	Inlet: Maximum 300 psig (21 bar) Outlet: Adjustable up to 100 psig (7 bar)		Knob: Acetal
Pressure Gauge	0-160 psig (0-11 bar); 1/8-NPT gauge ports front and rear		Seals: Nitrile

IMPORTANT NOTE: Please read carefully and thoroughly all of the **CAUTIONS, WARNINGS** on the inside back cover.

Port Sizes: 1/4, 3/8, 1/2 & 3/4 – Flow to 155 scfm



Internally Piloted Regulator				
Port Size	Pressure Range psig (bar)			
	15-200 (1-13.8)		15-250 (1-17.2)	
	Model Number		Model Number	
	NPTF Threads	G Threads	NPT F Threads	G Threads
1/4	5213C2018	C5213C2018	5214C2018	C5214C2018
3/8	5213C3018	C5213C3018	5214C3018	C5214C3018
1/2	5213C4018	C5213C4018	5214C4018	C5214C4018
3/4	5213C5018	C5213C5018	5214C5018	C5214C5018

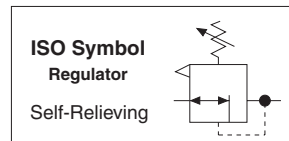

Port Size	Dimensions inches (mm)				Weight† lb (kg)
	A	B**	C***	Depth†	
1/4, 3/8, 1/2, 3/4	3.5 (89)	4.2 (106)	1.3 (33)	2.8 (71)	2.06 (0.92)

** Dome removal clearance: add 0.63 (16).
 *** Cap removal clearance: add 0.5 (13).
 † Less gauge.

Precision internal Pilot Regulators provide improved torque control for pneumatic tools; diaphragm type. Pressure settings held within 3 psig (0.2 bar).

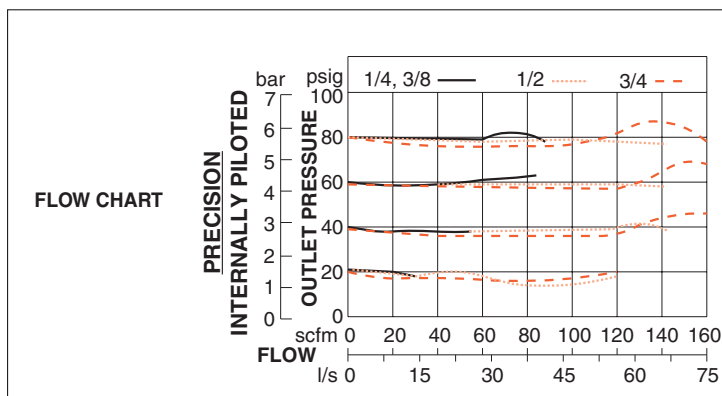

*Pressure Gauge included.
 Accessories ordered separately, refer to page G6.3-4.*

STANDARD SPECIFICATIONS (for regulators on this page):

Construction Design	Diaphragm Self-relieving	Panel Mounting	2-1/16 inch (52 mm) hole required
Temperature	Ambient/Media: 40° to 125°F (4° to 52°C)	Construction Material	Body: Zinc
Fluid Media	Compressed air		Dome: Nylon; Aluminum with optional 0 to 175 psig (0 to 12 bar) spring
Operating Pressure	Inlet: Maximum 300 psig (21 bar) Outlet: Adjustable 15 to 250 psig (1 to 17 bar)		Knob: Acetal
Optional Pressure Adjustment	Locking Key: Removable		Seals: Nitrile
Pressure Gauge	0 to 200 psig (0 to 14 bar); 1/4 NPT gauge ports front and rear		Valve: Brass Valve Cap: Nylon

IMPORTANT NOTE: Please read carefully and thoroughly all of the **CAUTIONS, WARNINGS** on the inside back cover.

Modular Precision Regulators

MD4™ Series

Port Sizes: 3/8, 1/2 & 3/4 – Flow to 170 scfm

Choose your options (in red) to configure your model number.

MD4 **52K** **E** **B** **5** **2** **B**

ADJUSTMENT RANGE	
15-200 psig (1.0-13.8 bar)	E
15-250 psig (1.0-17.2bar)	F
15-100 psig (1.0-6.9 bar)	G

PIPE SIZE	
3/8 NPTF	3
1/2 NPTF	4
3/4 NPTF	5
3/8 G	C
1/2 G	D
3/4 G	E

GAUGE	
Without Gauge	A
Gauge 0-200 psig (0-13.8 bar)	B
Without Gauge, with Panel Mount Nut	D
Gauge 0-200 psig (0-13.8 bar), with Panel Mount Nut	E

CAP COLOR	
Black	2
Yellow	Y

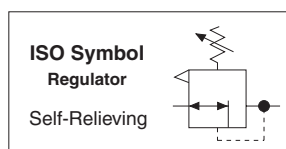

Port Size	Dimensions inches (mm)				Weight † lb (kg)
	A	B	C	Depth †	
3/8, 1/2, 3/4	3.5 (87)	4.8 (122)	1.6 (40)	2.9 (73)	2.3 (1.0)

† Dimensions reflect less gauge.

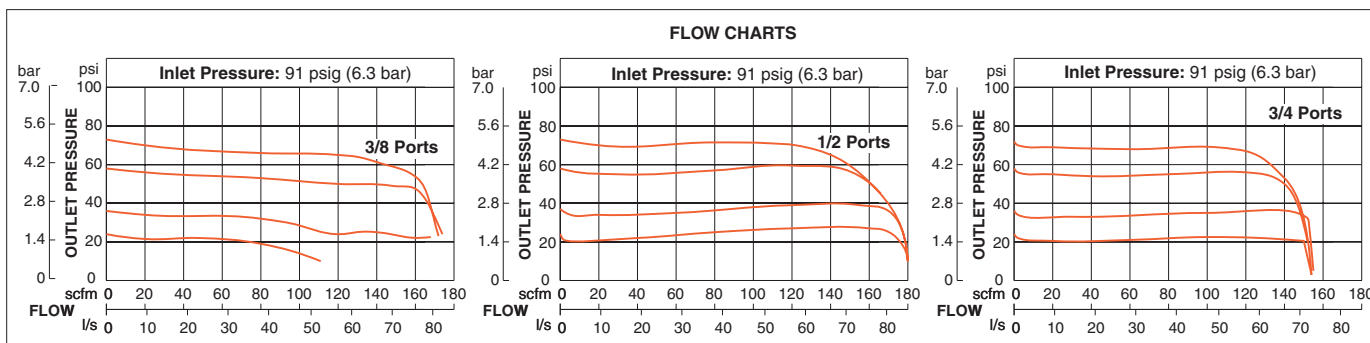
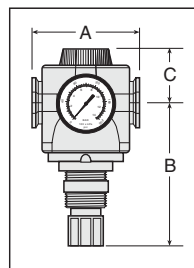

Accessories ordered separately, refer to page G6.3-5.

STANDARD SPECIFICATIONS (for regulators on this page):

Construction Design	Diaphragm Self-relieving	Construction Material	Body: Zinc
Temperature	Ambient/Media: 40° to 125°F (4° to 52°C)		Bonnet and Knob: Acetal
Fluid Media	Compressed air		Dome: Zinc
Operating Pressure	Inlet: Maximum 250 psig (17 bar) Outlet: Adjustable 15 to 250 psig (1 to 17 bar)		Seals: Nitrile
Pressure Gauge	0 to 200 psig (0 to 14 bar); 1/4 NPT gauge ports front and rear		Valve: Brass
Panel Mounting	2-1/16 (52 mm) hole required		Precision Regulators: Provide improved torque control for pneumatic tools; diaphragm type. Pressure settings held within 3 psig (0.2 bar)

IMPORTANT NOTE: Please read carefully and thoroughly all of the **CAUTIONS, WARNINGS** on the inside back cover.

In-line Precision Regulators

HIGH-CAPACITY Series

Port Sizes: 3/4, 1, 1¼, 1½ – Flow to 800 scfm

Port Size	Pressure Range psig (bar)			
	15-200 (1-13.8)		15-250 (1-17.2)	
	Model Number		Model Number	
	NPTF Threads	G Threads	NPTF Threads	G Threads
3/4	5213D5017	C5213D5017	5214D5017	C5214D5017
1	5213D6017	C5213D6017	5214D6017	C5214D6017
1¼	5213D7017	C5213D7017	5214D7017	C5214D7017
1½	5213D8017	C5213D8017	5214D8017	C5214D8017

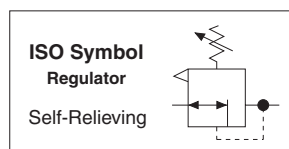

Port Size	Dimensions inches (mm)				Weight † lb (kg)
	A	B	C	Depth †	
3/4, 1	4.4 (111)	4.6 (112)	2.4 (62)	2.8 (71)	2.0 (0.91)
1¼, 1½	4.9 (124)	4.9 (125)	2.1 (54)	2.8 (71)	2.38 (1.08)

† Dimensions reflect less gauge.

FLOW CHARTS

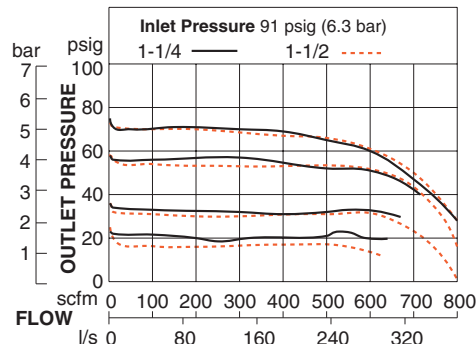
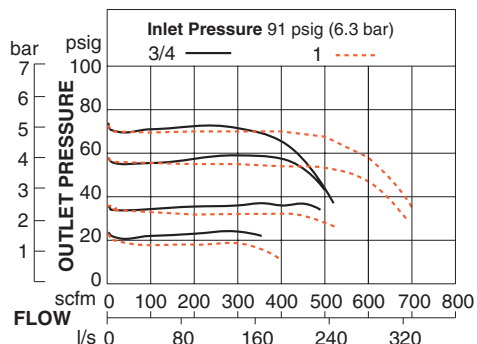

Precision Regulators:

Provide improved torque control for pneumatic tools. Pressure settings held within 3 psig (0.2 bar).

Pressure Gauge included.

Accessories ordered separately, refer to page G6.3-4.

STANDARD SPECIFICATIONS (for regulators on this page):

Construction Design	Diaphragm Self-relieving	Construction Material	Body: Aluminum
Temperature	Ambient/Media: 40° to 175°F (4° to 79°C)		Bonnet and Knob: Acetal
Fluid Media	Compressed air		Dome: Zinc
Operating Pressure	Inlet: Maximum 300 psig (21 bar) Outlet: Adjustable 15 to 250 psig (1 to 17 bar)		Seals: Nitrile
Pressure Gauge	0 to 200 psig (0 to 14 bar); 1/4 NPT gauge ports front and rear		Valve: Brass
Panel Mounting	1-3/16 (30 mm) hole required		Valve Cap: Nylon

IMPORTANT NOTE: Please read carefully and thoroughly all of the **CAUTIONS, WARNINGS** on the inside back cover.



Online Version
02/01/21



www.rosscontrols.com

G2.15

Modular Remote Pilot Regulators

FULL-SIZE Series

Port Sizes: 1/4, 3/8, 1/2, 3/4 – Flow to 155 scfm

Port Size	Pressure Range psig (bar)	
	0-200 (0-13.8)	
	Model Number	
	NPTF Threads	G Threads
1/4	5211C2007	C5211C2007
3/8	5211C3007	C5211C3007
1/2	5211C4007	C5211C4007
3/4	5211C5007	C5211C5007

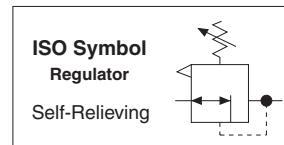

Port Size	Dimensions inches (mm)				Weight† lb (kg)
	A	B**	C***	Depth†	
1/4, 3/8, 1/2, 3/4	3.5 (89)	2.4 (62)	1.3 (33)	2.8 (71)	2.06 (0.92)

** Dome removal clearance: add 0.63 (16).
*** Cap removal clearance: add 0.5 (13).
† Less gauge.

Remote Pilot Regulators use any small regulator to provide remote adjustment and to ensure accurate pressure control.

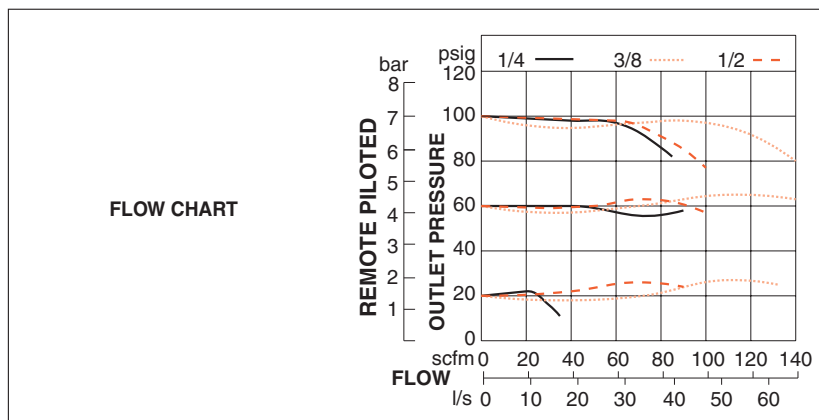

Pressure Gauge included.
Accessories ordered separately, refer to page G6.3-4.

STANDARD SPECIFICATIONS (for regulators on this page):

Construction Design	Diaphragm Self-relieving	Construction Material	Body: Zinc
Temperature	Ambient/Media: 40° to 125°F (4° to 52°C)		Dome: Zinc
Fluid Media	Compressed air		Knob: Acetal
Operating Pressure	Inlet: Maximum 300 psig (21 bar) Outlet: Adjustable 15 to 250 psig (1 to 17 bar)		Seals: Nitrile
Pressure Gauge	0 to 200 psig (0 to 14 bar); 1/4 NPT gauge ports front and rear		Valve: Brass
Panel Mounting	2-1/16 inch (52 mm) hole required		Valve Cap: Nylon

IMPORTANT NOTE: Please read carefully and thoroughly all of the **CAUTIONS, WARNINGS** on the inside back cover.

Modular Remote High-Relief Pilot Regulators

FULL-SIZE Series

Port Sizes: 1/4, 3/8, 1/2 & 3/4 – Flow to 150 scfm



Port Size	Model Number	
	NPTF Threads	G Threads
1/4	5X00B2037	C5X00B2037
3/8	5X00B3025	C5X00B3025
1/2	5X00B4040	C5X00B4040
3/4	5X00B5035	C5X00B5035

Port Size	Dimensions inches (mm)				Weight † lb (kg)
	A	B	C	Depth †	
1/4, 3/8, 1/2, 3/4	3.5 (87)	2.4 (62)	1.3 (33)	2.8 (71)	2.06 (0.92)

† Dimensions reflect less gauge.

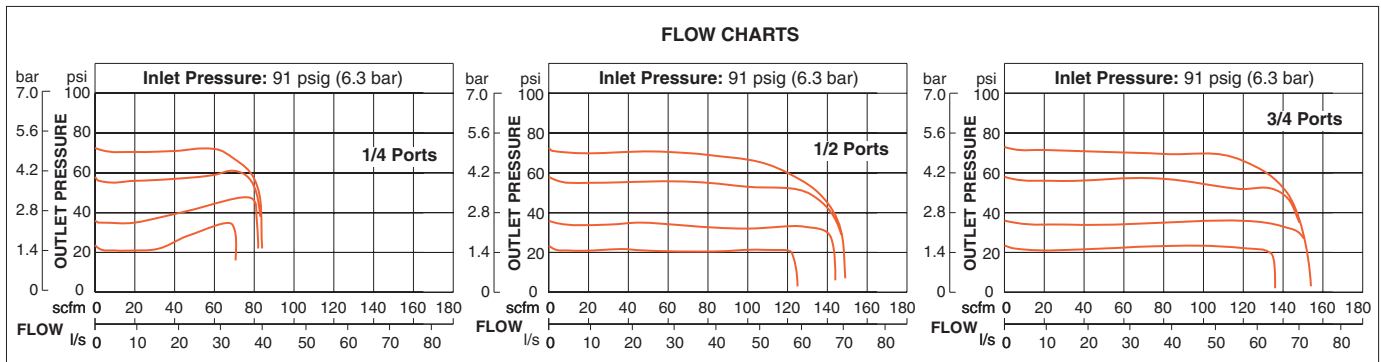
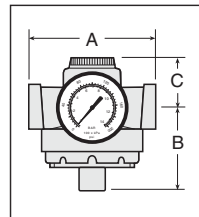
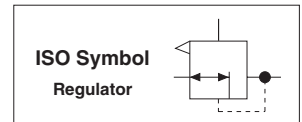

Pressure Gauge included.
Accessories ordered separately, refer to page G6.3-4.

STANDARD SPECIFICATIONS (for regulators on this page):

Construction Design	Diaphragm Self-relieving	Panel Mounting	2-1/16 inch (52 mm) hole required
Temperature	Ambient/Media: 40° to 175°F (4° to 79°C)	Construction Material	Body: Zinc
Fluid Media	Compressed air		Dome: Zinc
Operating Pressure	Inlet: Maximum 300 psig (21 bar) Outlet: Adjustable 15 to 200 psig (1 to 14 bar)		Seals: Nitrile; Fluoroelastomer seals optional, consult ROSS
Pressure Gauge	0 to 200 psig (0 to 14 bar); 1/4 NPT gauge ports front and rear		Valve: Brass
Pilot Ports	1/4 NPTF		Valve Cap: Nylon

IMPORTANT NOTE: Please read carefully and thoroughly all of the **CAUTIONS, WARNINGS** on the inside back cover.



Online Version
02/01/21



www.rosscontrols.com

G2.17

In-line Premium High-Relief Remote Pilot Regulators

FULL-SIZE Series

Port Sizes: 1/4, 3/8 & 1/2 – Flow to 150 scfm

Port Size	Model Number	
	NPTF Threads	G Threads
1/4	5216A2007	C5216A2007
3/8	5216A3007	C5216A3007
1/2	5216A4007	C5216A4007



Port Size	Dimensions inches (mm)				Weight† lb (kg)
	A	B**	C***	Depth†	
1/4, 3/8, 1/2	4.18 (106)	1.54 (39.1)	3.52 (89.3)	4.18 (106)	4.84 (2.2)

** Dome removal clearance: add 0.63 (16).

*** Cap removal clearance: add 0.5 (13).

† Less gauge.

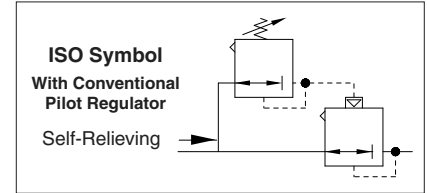
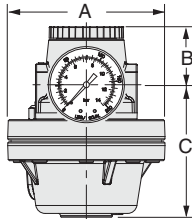

FLOW CHARTS

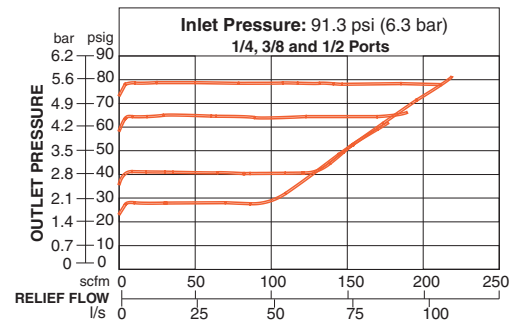
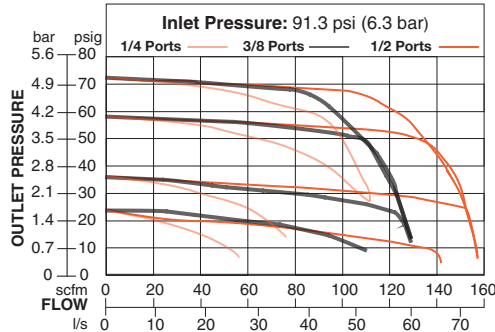

Pressure Gauge included.
Accessories ordered separately, refer to page G6.3-4.

STANDARD SPECIFICATIONS (for regulators on this page):

Construction Design	Diaphragm Self-relieving	Pressure Gauge	0 to 200 psig (0 to 14 bar) standard, 1/4-NPTF (1/4 BSPP) gauge ports front and rear; 0 to 600 psig (0 to 40 bar) optional
Temperature	Ambient/Media: 0° to 158°F (-18° to 70°C)		Construction Material
Fluid Media	Compressed air	Dome: Zinc	
Operating Pressure	Inlet: Maximum 400 psig (28 bar)	Seals: Nitrile	
	Outlet: Adjustable up to 250 psig (17 bar)	Valve: Brass	
		Valve Cap: Glass filled Nylon	

IMPORTANT NOTE: Please read carefully and thoroughly all of the **CAUTIONS, WARNINGS** on the inside back cover.

Modular Remote Pilot Regulators

MD4™ Series

Port Sizes: 3/8, 1/2 & 3/4 – Flow to 190 scfm

Choose your options (in red) to configure your model number.

MD4 52K 1 B 5 2 B

RELIEF OPTION	
Relieving	1
Non-relieving	2

PIPE SIZE	
3/8 NPTF	3
1/2 NPTF	4
3/4 NPTF	5
3/8 G	C
1/2 G	D
3/4 G	E

CAP COLOR	
Black	2
Yellow	Y

GAUGE	
Without Gauge	A
Gauge 0-200 psig (0-13.8 bar)	B

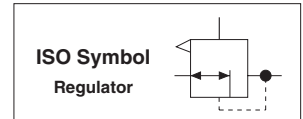

Port Size	Dimensions inches (mm)				Weight † lb (kg)
	A	B	C	Depth †	
1/4, 3/8, 1/2, 3/4	3.5 (87)	2.4 (62)	1.6 (41)	2.9 (73)	2.2 (1.0)

† Dimensions reflect less gauge.

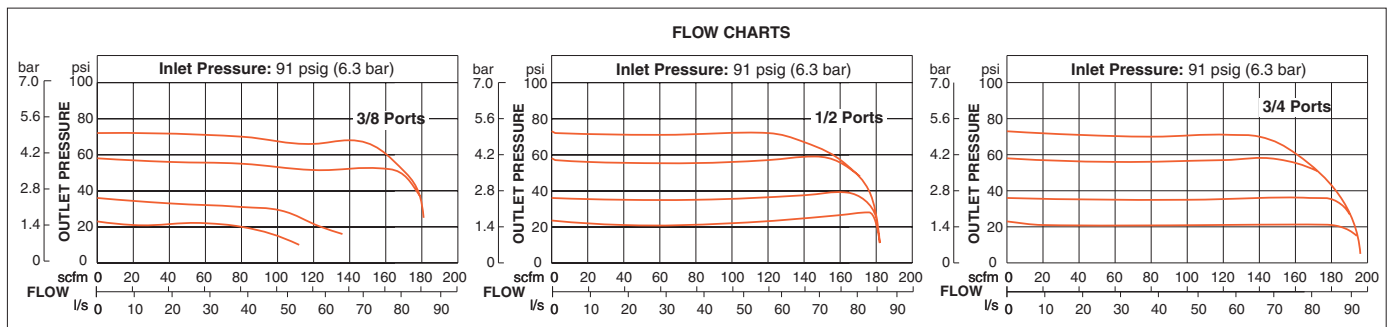
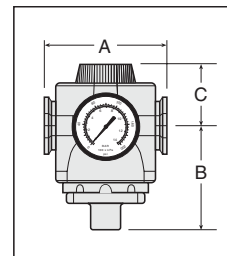

Accessories ordered separately, refer to page G6.3-5.

STANDARD SPECIFICATIONS (for regulators on this page):

Construction Design	Diaphragm Self-relieving	Pressure Gauge	0 to 200 psig (0 to 14 bar) standard, 1/4-NPTF (1/4 BSPP) gauge ports front and rear;
Temperature	Ambient/Media: 40° to 175°F (4° to 79°C)	Construction Material	Body: Zinc
Fluid Media	Compressed air		Dome: Zinc
Operating Pressure	Inlet: Maximum 300 psig (21 bar)		Seals: Nitrile
	Outlet: Adjustable 0 to 250 psig (0 to 17 bar)		Valve: Brass
		Valve Cap: Nylon	

IMPORTANT NOTE: Please read carefully and thoroughly all of the **CAUTIONS, WARNINGS** on the inside back cover.



Online Version
02/01/21



www.rosscontrols.com

G2.19

In-line Remote Pilot Regulators

HIGH-CAPACITY Series

Port Sizes: 3/4, 1, 1¼ & 1½– Flow to 740 scfm

Port Size	Model Number	
	NPTF Threads	G Threads
3/4	5211D5006	C5211D5006
1	5211D6007	C5211D6007
1¼	5211D7007	C5211D7007
1½	5211D8007	C5211D8007



Port Size	Dimensions inches (mm)				Weight† lb (kg)
	A	B*	C**	Depth†	
3/4, 1	4.4 (111)	2.9 (74)	2.4 (62)	2.8 (71)	1.88 (0.85)
1¼, 1½	4.9 (124)	3.2 (81)	2.1 (54)	2.8 (71)	2.25 (1.02)

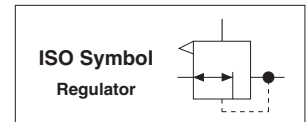
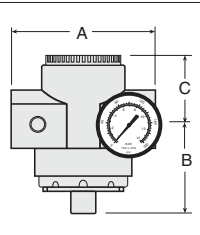

† Less gauge.

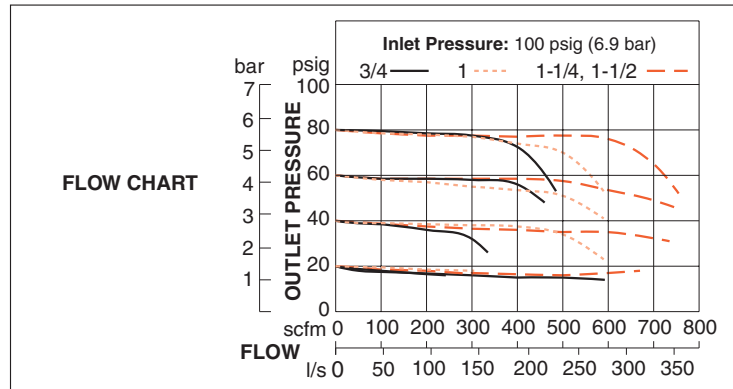

Pressure Gauge included.

Accessories ordered separately, refer to page G6.3-4.

STANDARD SPECIFICATIONS (for regulators on this page):

Construction Design	Diaphragm Self-relieving	Pressure Gauge	0 to 200 psig (0 to 14 bar) standard, 1/4-NPTF gauge ports front and rear
Temperature	Ambient/Media: 40° to 175°F (4° to 79°C)	Construction Material	Body: Aluminum
Fluid Media	Compressed air		Dome: Zinc
Operating Pressure	Inlet: Maximum 300 psig (21 bar) Outlet: Adjustable 0 to 200 psig (0 to 14 bar) NOTE: Outlet pressure depends on the adjustment of the pilot regulator		Seals: Nitrile
	Pilot Ports		1/4-NPTF

IMPORTANT NOTE: Please read carefully and thoroughly all of the **CAUTIONS, WARNINGS** on the inside back cover.

In-line High-Relief Remote Pilot Regulators

HIGH-CAPACITY Series

Port Sizes: 3/4, 1, 1¼ & 1½ – Flow to 700 scfm

Port Size	Model Number	
	NPTF Threads	G Threads
3/4	5X00B5046	C5X00B5046
1	5X00B6039	C5X00B6039
1¼	5X00B7021	C5X00B7021
1½	5X00B8049	C5X00B8049



Port Size	Dimensions inches (mm)				Weight† lb (kg)
	A	B**	C***	Depth†	
3/4, 1	4.4 (111)	2.9 (74)	2.4 (62)	2.8 (71)	1.88 (0.85)
1¼, 1½	4.9 (124)	3.2 (81)	2.1 (54)	2.8 (71)	2.25 (1.02)

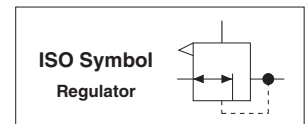
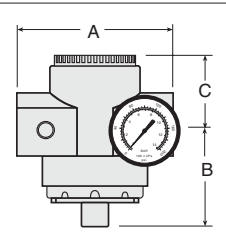

** Dome removal clearance: add 0.63 (16).
 *** Cap removal clearance: add 0.5 (13).
 † Less gauge.

FLOW CHARTS

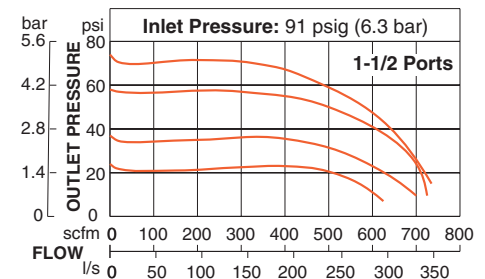
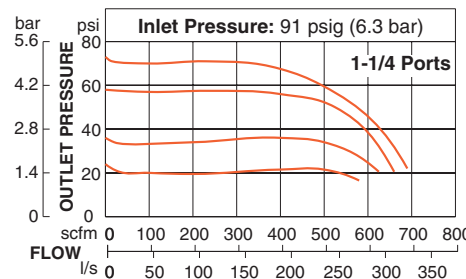
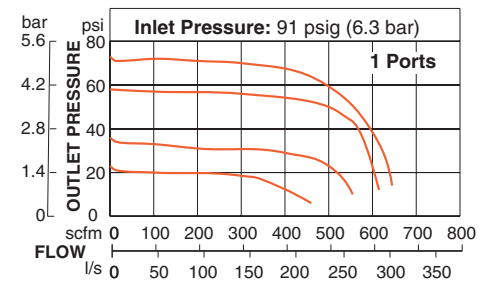
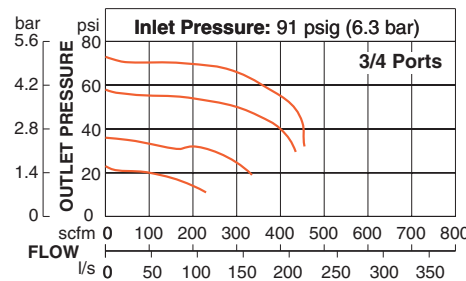

*Pressure Gauge included.
 Accessories ordered separately, refer to page G6.3-4.*

STANDARD SPECIFICATIONS (for regulators on this page):

Construction Design	Diaphragm Self-relieving	Pressure Gauge	0 to 200 psig (0 to 14 bar) standard, 1/4-NPTF) gauge ports front and rear
Temperature	Ambient/Media: 40° to 175°F (4° to 79°C)	Construction Material	Body: Aluminum
Fluid Media	Compressed air		Dome: Zinc
Operating Pressure	Inlet: Maximum 300 psig (21 bar) Outlet: Adjustable 0 to 200 psig (0 to 14 bar)		Seals: Nitrile
Pilot Ports	1/4-NPTF		Valve: Brass
			Valve Cap: Nylon

IMPORTANT NOTE: Please read carefully and thoroughly all of the **CAUTIONS, WARNINGS** on the inside back cover.



Online Version
02/01/21



www.rosscontrols.com

G2.21

In-line Premium High-Relief Remote Pilot Regulators

HIGH-CAPACITY Series

Port Sizes: 3/4, 1 & 1 1/4 – Flow to 400 scfm

Port Size	Model Number	
	NPTF Threads	G Threads
3/4	5216A5007	C5216A5007
1	5216A6007	C5216A6007
1 1/4	5216A7007	C5216A7007



Port Size	Dimensions inches (mm)				Weight† lb (kg)
	A	B**	C***	Depth†	
3/4, 1, 1 1/4	4.18 (117)	1.87 (47.5)	3.99 (101.3)	4.18 (106)	6.44 (3.0)

** Dome removal clearance: add 0.63 (16).
 *** Cap removal clearance: add 0.5 (13).
 † Less gauge.

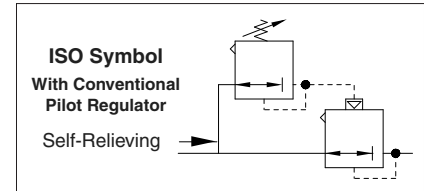
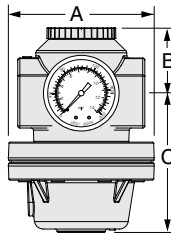

FLOW CHARTS

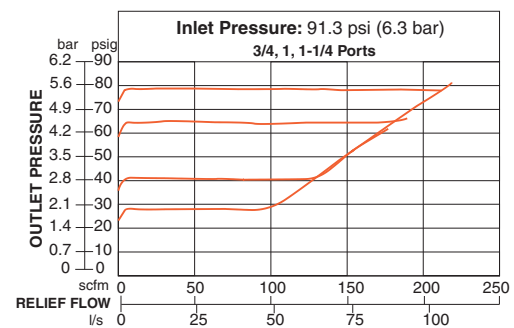
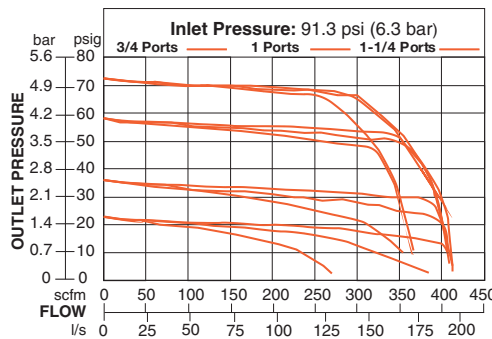

Pressure Gauge included.
Accessories ordered separately, refer to page G6.3-4.

STANDARD SPECIFICATIONS (for regulators on this page):

Construction Design	Diaphragm Self-relieving	Construction Material	Body: Zinc
Temperature	Ambient/Media: 0° to 158°F (-18° to 70°C)		Dome: Zinc
Fluid Media	Compressed air		Seals: Nitrile
Operating Pressure	Inlet: Maximum 400 psig (28 bar) Outlet: Adjustable up to 250 psig (up to 17 bar)		Valve: Brass
Pressure Gauge	0 to 200 psig (0 to 14 bar) standard, 1/4-NPTF (1/4 BSPP) gauge ports front and rear; 0 to 600 psig (0 to 40 bar) optional		Valve Cap: Glass filled Nylon

IMPORTANT NOTE: Please read carefully and thoroughly all of the **CAUTIONS, WARNINGS** on the inside back cover.

In-line Remote Pilot Regulators

HIGH-CAPACITY Series

Port Sizes: 1½, 2 & 3 – Flow to 4000 scfm

Flow to 850 scfm		
Port Size	Model Number	
	NPTF Threads	G Threads
1½	5211B8027	C5211B8027
2	5211B9007	C5211B9007



Flow to 4000 scfm			
Port Size	Seals	Model Number	
		NPTF Threads	G Threads
3	Nitrile	5211B9008	C5211B9008
3	Fluoroelastomer	5X00B9021	C5X00B9021

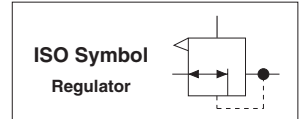

Port Size	Dimensions inches (mm)				Weight† lb (kg)
	A	B	C	Depth†	
1½, 2	6.4 (162)	5.0 (127)	3.0 (76)	2.8 (71)	8.94 (4.06)
3	8.4 (214)	7.36 (187)	3.74 (95)	8.0 (203)	21.77 (9.88)

† Less gauge.

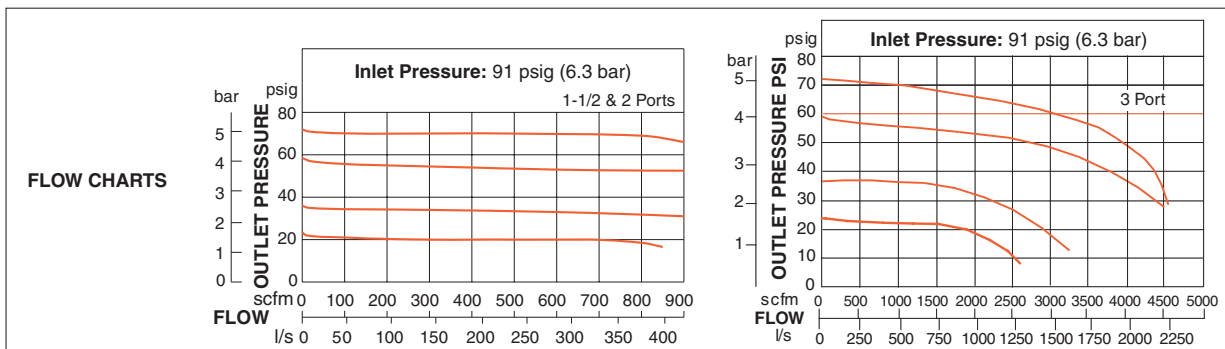
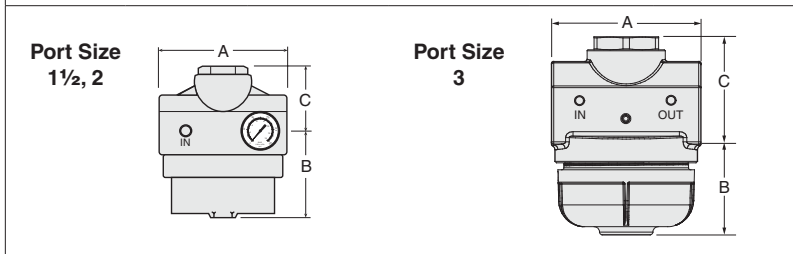

Pressure Gauge included.
Accessories ordered separately, refer to page G6.3-4.

STANDARD SPECIFICATIONS (for regulators on this page):

Construction Design	Piston Self-relieving	Pilot Ports	1/4-NPTF
Temperature	Ambient/Media: 40° to 175°F (4° to 79°C)	Pressure Gauge	0 to 200 psig (0 to 14 bar) standard, 1/4-NPTF gauge ports front and rear
Fluid Media	Compressed air	Construction Material	Body: Aluminum
Operating Pressure	Inlet: Maximum 300 psig (21 bar) Outlet: Adjustable 0 to 200 psig (0 to 14 bar) NOTE: Outlet pressure depends on the adjustment of the pilot regulator		Dome: Aluminum
	Pilot Ports		Seals: Nitrile
	1/4-NPTF	Valve: Brass on 1/2" & 2" ports; Aluminum on 3" ports Valve Cap: Aluminum	

IMPORTANT NOTE: Please read carefully and thoroughly all of the **CAUTIONS, WARNINGS** on the inside back cover.



Online Version
02/01/21



www.rosscontrols.com

Port Sizes: 1/8 & 1/4 – Flow to 40 scfm

Port Size	Port Threads	Pressure Range psig (bar)			
		1-15 (0.07-1.0)	1-30 (0.07-2.1)	1-50 (0.07-3.4)	1-140 (0.07-9.6)
		Model Number	Model Number	Model Number	Model Number
1/8	NPTF	5210B1002	5210B1003	5210B1004	5210B1001
	G	C5210B1002	C5210B1003	C5210B1004	C5210B1001
1/4	NPTF	5210B2002	5210B2003	5210B2004	5210B2001
	G	C5210B2002	C5210B2003	C5210B2004	C5210B2001



Port Size	Dimensions inches (mm)				Weight† lb (kg)
	A	B	C	Depth†	
1/8, 1/4	1.6 (41)	2.7 (68)	0.4 (10)	1.6 (41)	0.24 (0.11)

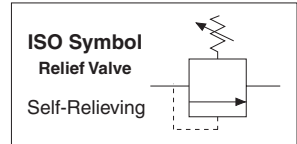
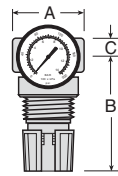

†Less gauge.

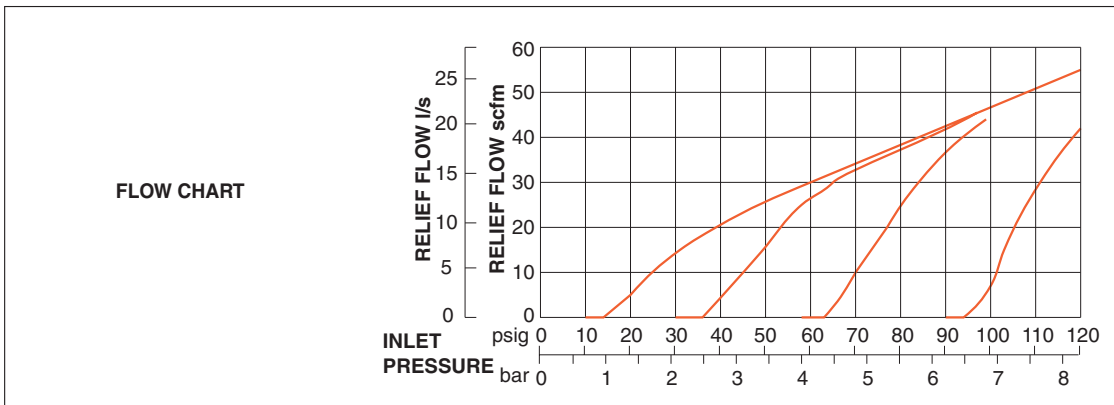

Relief Valves have maximum relief flows of 10 to 20 scfm (4.7 to 9.4 l/s).
For models with increased sensitivity at lower pressure, consult ROSS.

Pressure Gauge included.
Accessories ordered separately, refer to page G6.3-4.

STANDARD SPECIFICATIONS (for valves on this page):

Construction Design	Diaphragm Self-relieving	Panel Mounting	1-3/16 inch (30 mm) hole required
Temperature	Ambient/Media: 40° to 125°F (4° to 52°C)	Construction Material	Body: Aluminum
Fluid Media	Compressed air		Dome: Acetal
Operating Pressure	Inlet: Maximum 300 psig (21 bar) Outlet: Adjustable 1 to 140 psig (0.07 to 9.6 bar)		Knob: Acetal
Pressure Gauge	0 to 160 psig (0 to 11 bar); 1/8 NPT gauge ports front and rear		Seals: Nitrile; Fluoroelastomer seals optional, consult ROSS

IMPORTANT NOTE: Please read carefully and thoroughly all of the **CAUTIONS, WARNINGS** on the inside back cover.

Port Sizes: 1 – Flow to 450 scfm

Port Size	Model Number	
	NPTF Threads	G Threads
1	5X00D6012	C5X00D6012



Port Size	Dimensions inches (mm)				Weight lb (kg)
	A	B	C	Depth	
1	4.4 (111)	4.8 (122)	2.5 (62)	2.9 (72)	1.8 (0.8)

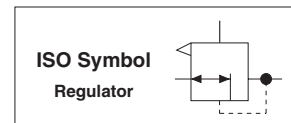
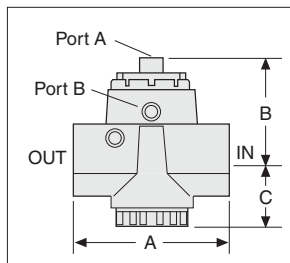

On the right is a typical circuit using the High-Flow Relief Valve. The circuit utilizes a remotely piloted “fill” regulator (port size 1 NPT) and a small, remotely mounted, pilot regulator with 1/4 NPT ports.

The required system pressure is set by adjusting the knob on the pilot regulator until the desired system pressure is shown on the pilot regulator’s gauge. An example system pressure of 50 psig was selected in the circuit.

Outlet pressure from the pilot regulator is sent to the fill regulator’s signal port and the Port 2 of the High-Flow Relief Valve. The Port 1 of the High-Flow Relief Valve is connected to the system, as shown, to monitor system pressure.

If the system pressure exceeds the pilot regulator setting (set-point), the High-Flow Relief Valve will begin to exhaust air after an approximate 2 psig (0.1 bar) rise above the set-point.

Should the system pressure drop below the set-point, the fill valve will open to supply air downstream and maintain the system at the set-point.

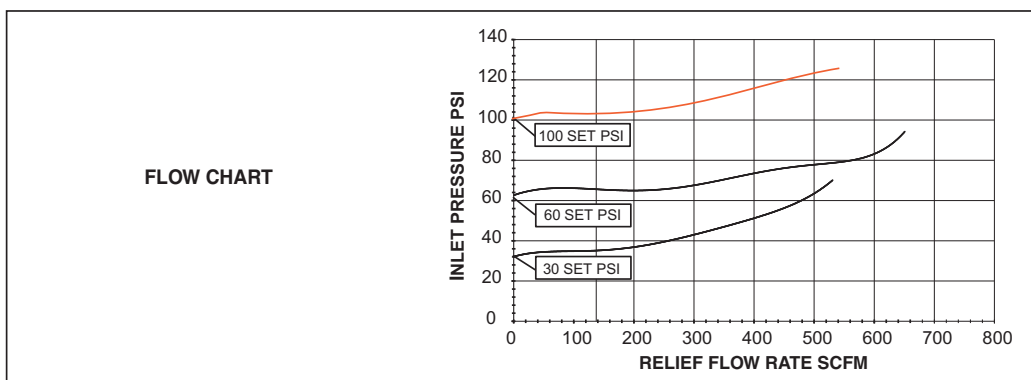
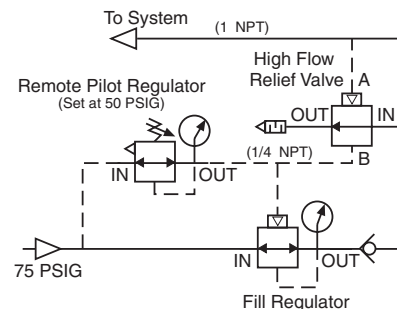

Accessories ordered separately, refer to page G6.3-4.

STANDARD SPECIFICATIONS (for valves on this page):

Construction Design	Diaphragm Self-relieving	Pilot Ports	1/4 NPTF
Temperature	Ambient/Media: 40° to 175°F (4° to 79°C)	Construction Material	Body: Aluminum
Fluid Media	Compressed air		Dome: Zinc
Operating Pressure	Inlet: Maximum 200 psig (14 bar) Outlet: Adjustable 0 to 200 psig (0 to 14 bar)		Seals: Nitrile
Pressure Gauge	0 to 200 psig (0 to 14 bar); 1/4 NPT gauge ports front and rear		Valve: Brass
			Valve Cap: Nylon

IMPORTANT NOTE: Please read carefully and thoroughly all of the **CAUTIONS, WARNINGS** on the inside back cover.

HOW TO ORDER

Choose your options (in red) to configure your model number.

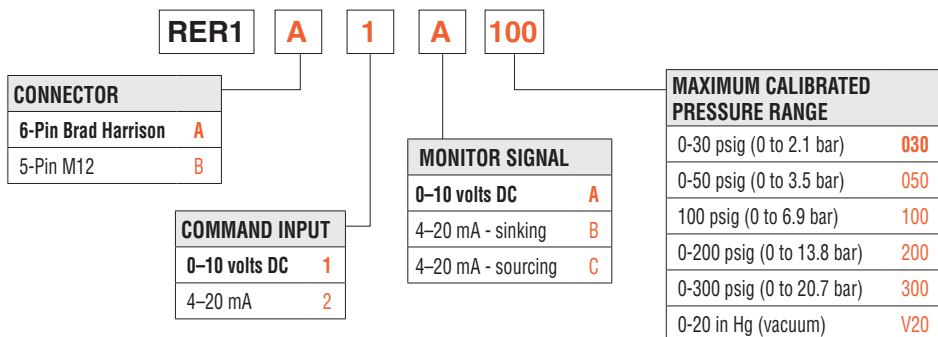

Accessories ordered separately, see below.

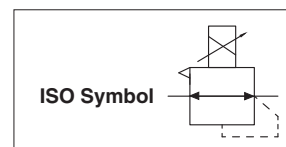

ACCESSORIES

Cables

For 6-Pin Brad Harrison Connector.

Cable Length	Model Number*
6 feet (1.8 meters)	RER-CBL-6
12 feet (3.7 meters)	RER-CBL-12
25 feet (7.5 meters)	RER-CBL-25

*For cables for 5-Pin M12 connector, consult ROSS.



STANDARD SPECIFICATIONS (for valves on this page):

Supply Voltage/Current	15 – 24 volts DC/250 mA (required)		Body: Zinc
Analog Monitor Signal:	Voltage: 0 – 10 volts DC@20 mA maximum Current: 4 – 20 mA sinking (sourcing optional)	Construction Material	Dome: Zinc
Command Signal Impedance:	Voltage: 4.7 kΩ Current: 100Q		Housing: Aluminum; powder coated
Command Signal Voltage/Current:	0 – 10 volts DC/4 – 20 mA		Manifold: Brass
Electrical Connector:	6-pin Brad Harrison or 5-pin M12		Seals: Fluorocarbon
Temperature	Ambient/Media: 32° to 158°F (0° to 70°C)	Accuracy:	< ± .25% F.S.
Fluid Media	Compressed air	Linearity/Hysteresis:	< ± .2% F.S. BFSL
Operating Pressure	Input: 29.9 in Hg to 300 psig (760 mm Hg to 21 bar) Output: 0 to 200 psi (0 to 14 bar)	Repeatability:	< ± .2% F.S.
		<i>Note: High-pressure Proportional valve Q175 psi (12 bar) - inlet and exhaust ports reversed from picture shown</i>	

IMPORTANT NOTE: Please read carefully and thoroughly all of the **CAUTIONS, WARNINGS** on the inside back cover.

E-P Proportional Valves with Volume Booster

RB Series

Port Sizes: 1½, 2 & 3 – Flow to 4000 scfm



RB 1 2 A RER1 A 1 A 100

REGULATOR TYPE	
1/4 to 3/4 - Self Relieving	1
3/4 to 1½ - Self Relieving	2
1/4 to 1/2 - High-Relief	3
3/4 to 1¼ - High-Relief	4

CONNECTOR	
6-Pin Brad Harrison	A
5-Pin M12	B

MAXIMUM CALIBRATED PRESSURE RANGE	
0-30 psig (0 to 2.1 bar)	030
0-50 psig (0 to 3.5 bar)	050
0-100 psig (0 to 6.9 bar)	100
0-200 psig (0 to 13.8 bar)	200
0-300 psig (0 to 20.7 bar)	300
0-20 in Hg (vacuum)	V20

INLET/OUTLET PORTS			
1/4 NPTF	2	1/4 G	B
3/8 NPTF	3	3/8 G	C
1/2 NPTF	4	1/2 G	D
3/4 NPTF	6	3/4 G	E
1 NPTF	8	1 G	F
1¼ NPTF	J	1¼ G	G
1½ NPTF	K	1½ G	H

GAUGE	
Without Gauge	A
Gauge 0-200 psig (0-13.8 bar)	B
Gauge 0-600 psig (0-40 bar)	C
Gauge 0-30 psig (0-2 bar)	D
Gauge 0-60 psig (0-4 bar)	E

For Electronic Gauge, consult ROSS.

COMMAND INPUT	
0-10 volts DC	1
4-20 mA	2

MONITOR SIGNAL	
0-10 volts DC	A
4-20 mA - sinking	B
4-20 mA - sourcing	C

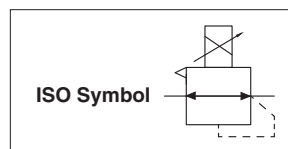

Accessories ordered separately, see below.

Regulator Pressure Model	Inlet psi (bar)	Outlet psi (bar)	Relief scfm
RB1 - RB2	300 (20.7)	200 (13.8)	627
RB3 - RB4	400 (27.6)	250 (17.3)	200

Brass Inlet Filter (R37-R288) is included when purchasing a proportional-valve.
NOTE: Cable not included with the product, see choices below.



ACCESSORIES

Mounting Bracket Kit

Regulator Type	Kit Number ¹
Self Relieving	RER-BRK-1
High-Relief	R-A37-381



Cables

For 6-Pin Brad Harrison Connector.

Cable Length	Model Number*
6 feet (1.8 meters)	RER-CBL-6
12 feet (3.7 meters)	RER-CBL-12
25 feet (7.5 meters)	RER-CBL-25

*For cables for 5-Pin M12 connector, consult ROSS.



STANDARD SPECIFICATIONS (for valves on this page):

Supply Voltage/Current	15 – 24 volts DC/250 mA (required)	Construction Material	Body: Zinc	
Analog Monitor Signal:	Voltage: 0 – 10 volts DC@20 mA maximum Current: 4 – 20 mA sinking (sourcing optional)		Dome: Zinc	
Command Signal Impedance:	Voltage: 4.7 kΩ Current: 100Q		Housing: Aluminum; powder coated	
Command Signal Voltage/Current:	0 – 10 volts DC/4 – 20 mA		Manifold: Brass	
Electrical Connector:	6-pin Brad Harrison or 5-pin M12		Seals: Fluorocarbon	
Temperature	Ambient/Media: 32° to 158°F (0° to 70°C)		Transducer: Silicon, Aluminum	
Fluid Media	Compressed air		Valve: Nickel-plated Brass	
Operating Pressure	Input: 29.9 in Hg to 300 psig (760 mm Hg to 21 bar) Output: 0 to 200 psi (0 to 14 bar)		Accuracy:	< ± .25% F.S.
			Linearity/Hysteresis:	< ± .2% F.S. BFSL
			Repeatability:	< ± .06% F.S.

IMPORTANT NOTE: Please read carefully and thoroughly all of the **CAUTIONS, WARNINGS** on the inside back cover.



Online Version
02/01/21



www.rosscontrols.com

G2.27



ACCESSORIES



ROSS CONTROLS

SILENCERS							
Port Size	Thread Type	Model Number		Avg. C _v	Dimensions inches (mm)		Weight lb (kg)
		NPT Threads	R/Rp Threads		Length	Width	
1/8	Male	5500A1003	D5500A1003	1.2	0.9 (21)	2.0 (51)	0.1 (0.1)
1/4	Male	5500A2003	D5500A2003	2.1	0.9 (21)	2.2 (55)	0.1 (0.1)
3/8	Male	5500A3013	D5500A3013	2.7	0.9 (21)	2.2 (55)	0.1 (0.1)
		5500A3003	D5500A3003	4.3	1.3 (32)	3.5 (88)	0.2 (0.1)
1/2	Male	5500A4003	D5500A4003	4.7	1.3 (32)	3.6 (91)	0.2 (0.1)
3/4	Male	5500A5013	D5500A5013	5.1	1.3 (32)	3.6 (92)	0.2 (0.1)
		5500A5003	D5500A5003	11.5	2.0 (51)	5.3 (135)	0.6 (0.3)
1	Male	5500A6003	D5500A6003	14.6	2.0 (51)	5.4 (138)	0.6 (0.3)
1¼	Male	5500A7013	D5500A7013	16.4	2.0 (51)	5.5 (140)	0.6 (0.3)
	Female	5500A7001	D5500A7001	24	2.5 (64)	5.7 (144)	1.0 (0.5)
1½	Female	5500A8001	D5500A8001	29.9	2.5 (64)	5.7 (144)	1.0 (0.5)
2	Female	5500B9001	D5500B9001	34.2	3.0 (76)	6.6 (168)	1.5 (0.7)
2½	Female	5500A9002	D5500A9002	103.7	4.0 (102)	5.7 (145)	2.9 (1.4)

Pressure Range: 0 to 290 psig (0 to 20 bar) maximum. **Flow Media:** Filtered air.



Port size
1/8 thru 2



Port size 2½



Stainless Steel SILENCERS								
Port Size	Thread Type	Model Number		Avg. C _v	Dimensions inches (mm)		Weight lb (kg)	Construction
		NPT Threads	R/Rp Threads		Length	Width		
1/4	Male	5500B2004	D5500B2004	1.44	1.75 (44.5)	0.56 (14.2)	0.05 (0.23)	Stainless steel
1/2	Male	5500B4004	D5500B4004	3.01	2.75 (69.7)	0.87 (22.1)	0.25 (0.11)	
1	Male	5500B6004	D5500B6004	10.41	3.87 (98.3)	1.31 (33.3)	0.45 (0.20)	NPT - Stainless steel
2	Male	5500A9004	D5500A9004	28.11	5.50 (139.7)	2.37 (60.2)	1.5 (0.68)	R - Nickel plated cold rolled steel Nickel plated cold rolled steel

Supplied with a standard pipe thread fitting for attaching directly to the exhaust ports of air-operated equipment.
Pressure Range: 0 to 175 psig (0 to 12.3 bar) maximum. **Flow Media:** Filtered air.



SILENCERS for Stainless Steel L-O-X® Air Entry Assemblies							
Port Size	Thread Type	Model Number		Avg. C _v	Dimensions inches (mm)		Description
		NPT Threads	BSP Threads		Length	Width	
1/4	Male	5500A2005	D5500A2005	1.5	1.50 (38)	0.67 (17)	Pressure Range: 0 to 125 psig (0 to 8.6 bar) maximum. Seals: Nitrile.
1/2	Male	5500A4005	D5500A4005	3.5	2.17 (55)	0.94 (24)	
1	Male	5500A6005	D5500A6005	5.7	2.95 (75)	1.41 (36)	



Noise-Reduction SILENCERS for DM ¹ & DM ² ® Series C Double Valves								
Valve Model	Basic Size	Kit Number*		Flow scfm	Dimensions inches (mm)			
		NPT Threads	R/Rp Threads		A	B (NPT)	B (R)	C
DM Series C	2	2324H77	2329H77	800 (378)	4.34 (110.2)	19.06 (484.1)	21.40 (543.6)	7.27 (184.7)
	4	2324H77	2329H77	800 (378)	4.34 (110.2)	19.06 (484.1)	21.40 (543.6)	7.27 (184.7)
	8	2325H77	2329H77	800 (378)	5.41 (137.4)	21.18 (538.0)	23.52 (597.4)	8.41 (213.6)
	12	2326H77	2330H77	2080 (982)	6.74 (117.2)	25.85 (656.6)	28.20 (716.3)	10.66 (270.8)
	30	2327H77	2331H77	7200 (3398)	9.85 (250.2)	41.55 (1055.4)	41.55 (1055.4)	13.47 (342.1)

Pressure Range: 125 psig (8.6 bar) maximum.
* Kits include all plumbing required for installation.
Reduces the Exponentially Perceived Noise (EPNdB), Impact noise reduction in the 35–40 dB range
Recommended for air exhaust applications for pressures up to 125 psig (8.6 bar)
Pressure Range – 125 psig (8.6 bar) maximum

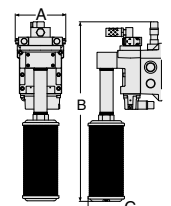

IMPORTANT NOTE: Please read carefully and thoroughly all of the **CAUTIONS, WARNINGS** on the inside back cover.

Noise-Reduction SILENCERS for DM ² ® Series D Double Valves						Description
Valve Basic Size	Thread Type	Kit Number*#	Flow scfm	Dimensions inches (mm)		
				Height	Width	
4	NPT	2324H77	800 (378)	19.1 (484)	4.4 (110)	Reduces the Exponentially Perceived Noise (EPNdB), Impact noise reduction in the 35–40 dB range Recommended for air exhaust applications for pressures up to 125 psig (8.6 bar) Pressure Range – 125 psig (8.6 bar) maximum
	BSPT	2329H77	800 (378)	21.4 (544)	4.4 (110)	
8	NPT	2325H77	800 (378)	21.2 (538)	5.4 (138)	
	BSPT	2330H77	800 (378)	23.5 (598)	5.4 (138)	
12	NPT	2326H77	2080 (982)	25.9 (657)	6.8 (117)	
	BSPT	2331H77	2080 (982)	28.2 (716)	6.8 (117)	
30	NPT	2327H77	7200 (3398)	41.6 (1056)	9.9 (250)	
	BSPT	2332H77				

* Kits include all plumbing required for installation.
Exhaust flange kit required, see below ordering information.



Exhaust Flange Kits for Noise Reduction Silencers	Valve Basic Size	Port Size	Kit Number		Used when installing noise reduction silencers
			NPT Threads	G Threads	
	4	1	726B25	D276B25	
8	1	617B25	D617B25		
12	1½	619B25	D619B25		
30	2½	621B25	D621B25		

Electrical CONNECTORS & CORD Sets

Connection Type	EN 175301-803 Connector		Fitting Connection	Cord Type/Termination		Length meters (feet)	Cord Diameter	Model Number			Cord Quantity
	Option	Form		End 1	End 2			Without Light	Lighted Connector		
									24 V DC	120 V AC	
Solenoid	Connector Only	A	–	–	–	–	–	937K87	936K87-W	936K87-Z	–
			1/2" NPT conduit	–	–	–	–	723K77	724K77-W	724K77-Z	–
		B	–	–	–	–	–	372K77	328K77-W	328K77-Z	–
		C	–	–	–	–	–	2452K77	2453K77-W	2453K77-Z	–
	Prewired Connector	A	–	Connector	Flying leads	2 (6.5)	6-mm	721K77	720K77-W	720K77-Z	1
							10-mm	371K77	383K77-W	383K77-Z	1
						5 (16.4)	–	2243H77	–	–	2
			10 (32.8)	–	2244H77	–	–	2			
		B	–	Connector	Flying leads	2 (6.5)	10-mm	266K77	267K77-W	267K77-Z	1
		C	–	Connector	Flying leads	2 (6.5)	5-mm	–	2476K77-W	2476K77-Z	1
						3 (10)	8-mm	2449K77	2450K77-W	2450K77-Z	1



CAUTIONS: Do not use electrical connectors with surge suppressors, as this may increase valve response time when de-actuating the solenoids.

PRESSURE Indicators

Pop-Up (Visual) Indicator	Model Number	Port Threads	May be installed on all valves with pressure sensing port. Provides a means to verify the release of downstream pressure to next obstruction.			
	988A30	1/8 NPT				
Stainless Steel Visual Indicator	Model Number	Port Threads	Dimensions inches (mm)		Weight lb (kg)	
	1155H30	1/8 NPT	A	B		
316 Stainless Steel Body, Internals and Springs, Nitrile Seals Visual Indicator piston, Acetal; Visual Indicator assembly, Acetal with acrylic lens						
Status Indicator	Model Number	The Status Indicator pressure switch actuates when the valve is in a ready-to-run condition and de-actuates when the valve is in a lockout condition or when the inlet air pressure has been removed.				
	670B94					



IMPORTANT NOTE: Please read carefully and thoroughly all of the **CAUTIONS, WARNINGS** on the inside back cover.

PRESSURE SWITCHES For Verification Of Downstream Pressure Release

Pressure Switch Type	Connection Type	Model Number	Port Threads	EN Connector Pinout	M12 Connector Pinout
Pressure Switches (Electrical) for Energy Release Verification	EN 175301-803 Form A	586A86	1/8 NPT		
	Pressure Switch M12	1153A30	M10x1		
	Solid State Pressure Sensor M12	1335B30W	M10x1		
Redundant Downstream Feedback Switch for Energy Release Verification	EN 175301-803 Form A	RC026-13	3/8 NPT		

Factory preset, 5 psi (0.3) - falling



May be installed on all valves with pressure sensing port.
Provides means to verify the release of downstream pressure to next obstruction.

Stainless Steel Pressure Switch	Inlet Port Size	Model Number	Weight lb (kg)
	1/8	1162A30	0.23 (.01)

316 Stainless Steel Body, Nitrile Seals, DPDT (Double-Pole Double-Throw Switch)
Factory preset 5 psi (falling)



NPT port threads.

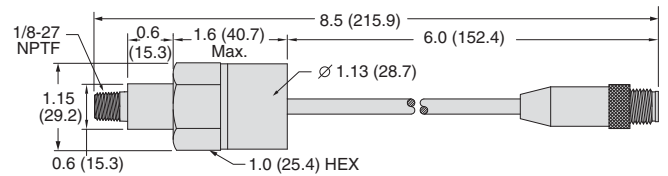

Digital PRESSURE TRANSDUCER For Digital Pressure Readout



Digital Pressure Transducer	Threads	Model Number	Pressure Range psig (bar)	Description			
				Electrical Output	Electrical Connection	Pressure Port Size/Type	Weight lb (Kg)
	NPT	760B94	0 (0) to 145 (10)	(1) PNP with (1) 4-20ma	M8, 4 Pin	1/8 NPT male	0.099 (0.045)

Analog 4-20mA Output, and Transistor Switching Output.

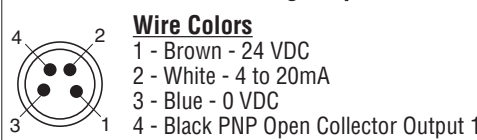
Sensor Pinout with Analog Output



Pressure GAUGES

	Type/Material	Port Size	Model Number		Pressure Range psig (bar)	Case Diameter inches (mm)	
			NPT Threads	G Threads			
Pressure Gauges (Center Back Mounting)	Standard Aluminum	1/8	5400A1002	D5400A1002	0-160 (0-11)	1.7 (43)	 
		1/4	5400A2010	D5400A2010	0-60 (0-4)	2.0 (51)	
		1/4	5400A2011	D5400A2011	0-200 (0-14)	2.0 (51)	
		1/4	5400A2012	D5400A2012	0-300 (0-20)	2.0 (51)	
	Liquid Filled Stainless Steel	1/4	5400A2014	D5400A2014	0-160 (0-11)	2.5 (64)	
		1/4	5400A2015*	D5400A2015*	0-160 (0-11)	2.0 (51)	

* Green shade between 40-70 psi (2.7-4.8 bar).

Multiple Lock-out Device

Model Number	
356A30	For use with any ROSS model valve with L-O-X® capability. Allows use of multiple lockout devices on a single energy isolation device.



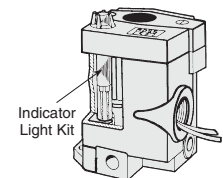

INDICATOR Light Kits for valves with Solenoid Controlled Pacer Pilot

Indicator Light Kits for 27 & 21 Series and SV27 & SV27 PO Check Valves	Kit Number			Indicator Light 
	24 volts DC	110-120 volts AC 50-60 Hz	220 volts 50-60 Hz	
	862K87-W	862K87-Z	862K87-Y	



To visually verify valve operation indicator lights are available in kit form. The indicator light extends through the solenoid or pilot cover and is illuminated when the solenoid is energized. Such lights are standard on double solenoid valves. Indicator light kit is available for single solenoid models.

Manual Override Kits	Flush Button			Extended Button			Extended Button with Palm		
	Locking Type	Kit Number		Locking Type	Kit Number		Locking Type	Kit Number	
	Non-Locking	790K87		Non-Locking	791K87		Non-Locking	984H87	
Locking	792K87	Locking	—	Locking	—				

Flush flexible manual overrides are standard on single solenoid models. Double solenoid models have flush metal-button overrides. Both types are non-locking. Each of the buttons in the override kits below is made of metal and is spring-returned. The locking type button, however, can be kept in the actuated position by turning the slot in the top of the button with a screwdriver.

CONNECTORS & CORD Sets

Connection Type	Connector Option	Connector Form	Fitting Connection	Cord Type/Termination		Length meters (feet)	Cord Diameter	Model Number		Cord Quantity
				End 1	End 2			Without Light	Lighted Connector 24 Volts DC	
Solenoid	Connector Only	EN 175301-803 Form A	-	-	-	-	-	937K87	936K87-W	-
			1/2" NPT conduit	-	-	-	-	723K77	724K77-W	-
	Prewired Connector	EN 175301-803 Form A	-	Connector	Flying leads	2 (6.5)	6-mm	721K77	720K77-W	1
						5 (16.4)	-	2243H77	-	2
						10 (32.8)	-	2244H77	-	2
Sensor	Prewired Connector	M12 5-pin, straight A-coded	-	Female	Flying leads	5 (16.4)	-	2644B77	-	2
					Male	5 (16.4)	-	2645B77	-	2
					Flying leads	10 (32.8)	-	2370B77	-	2
					Male	10 (32.8)	-	2371B77	-	2



CAUTIONS: Do not use electrical connectors with surge suppressors, as this may increase valve response time when de-actuating the solenoids.

General Information

Approvals and Certifications

ROSS products are designed to meet a number of industrial standards, including the Canadian Standards Association (C.S.A.) guidelines.

For certifications or information and on specific product approvals, visit ROSS' website at www.rosscontrols.com.

Information or Technical Assistance

For additional information or application assistance concerning ROSS products, visit ROSS' website at www.rosscontrols.com,

consult ROSS or your local ROSS distributor (see contact information on the back cover).

Order Placement

For order placement, consult ROSS or your local ROSS distributor.

For a current list of countries and local distributors, visit ROSS' website at www.rosscontrols.com.

CAUTIONS, WARNINGS And STANDARD WARRANTY

ROSS OPERATING VALVE, ROSS CONTROLS®, ROSS DECCO®, and AUTOMATIC VALVE INDUSTRIAL, collectively the “ROSS Group”.

PRE-INSTALLATION or SERVICE

1. Before servicing a valve or other pneumatic component, be sure all sources of energy are turned off, the entire pneumatic system is shut down and exhausted, and all power sources are locked out (ref: OSHA 1910.147, EN 1037).
2. All ROSS Group Products, including service kits and parts, should be installed and/or serviced only by persons having training and experience with pneumatic equipment. Because any product can be tampered with and/or need servicing after installation, persons responsible for the safety of others or the care of equipment must check ROSS Group Products on a regular basis and perform all necessary maintenance to ensure safe operating conditions.
3. All applicable instructions should be read and complied with before using any fluid power system to prevent harm to persons or equipment. In addition, overhauled or serviced valves must be functionally tested prior to installation and use. If you have any questions, call your nearest ROSS Group location.
4. Each ROSS Group Product should be used within its specification limits. In addition, use only ROSS Group components to repair ROSS Group Products.

WARNINGS: *Failure to follow these instructions can result in personal injury and/or property damage.*

FILTRATION and LUBRICATION

1. Dirt, scale, moisture, etc., are present in virtually every air system. Although some valves are more tolerant of these contaminants than others, best performance will be realized if a filter is installed to clean the air supply, thus preventing contaminants from interfering with the proper performance of the equipment. The ROSS Group recommends a filter with a 5-micron rating for normal applications.
2. All standard ROSS Group filters and lubricators with polycarbonate plastic bowls are designed for compressed air applications only. Use the metal bowl guard, where provided, to minimize danger from high pressure fragmentation in the event of bowl failure. Do not expose these products to certain fluids, such as alcohol or liquefied petroleum gas, as they can cause bowls to rupture, creating a combustible condition and hazardous leakage. Immediately replace crazed, cracked, or deteriorated bowls.
3. Only use lubricants which are compatible with materials used in the valves and other components in the system. Normally, compatible lubricants are petroleum base oils with oxidation inhibitors, an aniline

point between 180°F (82°C) and 220°F (104°C), and an ISO 32, or lighter, viscosity. Avoid oils with phosphate type additives which can harm polyurethane components, potentially leading to valve failure which risks personal injury, and/or damage to property.

WARNINGS: *Failure to follow these instructions can result in personal injury and/or property damage.*

AVOID INTAKE/EXHAUST RESTRICTION

1. Do not restrict air flow in the supply line. To do so could reduce the pressure of the supply air below minimum requirements for the valve and thereby causing erratic action.
2. Do not restrict a valve's exhaust port as this can adversely affect its operation. Exhaust silencers must be resistant to clogging and must have flow capacities at least as great as the exhaust capacities of the valves. Contamination of the silencer can result in reduced flow and increased back pressure.

WARNINGS: *Failure to follow these instructions can result in personal injury and/or property damage.*

SAFETY APPLICATIONS

1. Mechanical Power Presses and other potentially hazardous machinery using a pneumatically controlled clutch and brake mechanism must use a press control double valve with a monitoring device. A double valve without a self-contained monitoring device should be used only in conjunction with a control system which assures monitoring of the valve. All double valve installations involving hazardous applications should incorporate a monitoring system which inhibits further operation of the valve and machine in the event of a failure within the valve mechanism.
2. Safety exhaust (dump) valves without a self-contained monitoring device should be used only in conjunction with a control system which assures monitoring of the valve. All safety exhaust valve installations should incorporate a monitoring system which inhibits further operation of the valve and machine in the event of a failure within the valve mechanism.
3. Per specifications and regulations, the ROSS L-O-X® and L-O-X® with EEZ-ON®, N06 and N16 Series operation products are defined as energy isolation devices, NOT AS EMERGENCY STOP DEVICES.

WARNINGS: *Failure to follow these instructions can result in personal injury and/or property damage.*

STANDARD WARRANTY

All products sold by the ROSS Group are warranted for a one-year period [with the exception of Filters, Regulators and Lubricators (“FRLs”) which are warranted for a period of seven (7) years] from the date of purchase. All products are, during their respective warranty periods, warranted to be free of defects in material and workmanship. The ROSS Group’s obligation under this warranty is limited to repair, replacement or refund of the purchase price paid for products which the ROSS Group has determined, in its sole discretion, are defective. All warranties become void if a product has been subject to misuse, misapplication, improper maintenance, modification or tampering. Products for which warranty protection is sought must be returned to the ROSS Group freight prepaid.

THE WARRANTY EXPRESSED ABOVE IS IN LIEU OF AND EXCLUSIVE OF ALL OTHER WARRANTIES AND THE ROSS GROUP EXPRESSLY DISCLAIMS ALL OTHER WARRANTIES EITHER EXPRESSED OR IMPLIED WITH RESPECT TO MERCHANTABILITY OR FITNESS FOR A PARTICULAR PURPOSE. THE ROSS GROUP MAKES NO WARRANTY WITH RESPECT TO ITS PRODUCTS MEETING THE PROVISIONS OF ANY GOVERNMENTAL OCCUPATIONAL SAFETY AND/OR HEALTH LAWS OR REGULATIONS. IN NO EVENT IS THE ROSS GROUP LIABLE TO PURCHASER, USER, THEIR EMPLOYEES OR OTHERS FOR INCIDENTAL OR CONSEQUENTIAL DAMAGES WHICH MAY RESULT FROM A BREACH OF THE WARRANTY DESCRIBED ABOVE OR THE USE OR MISUSE OF THE PRODUCTS. NO STATEMENT OF ANY REPRESENTATIVE OR EMPLOYEE OF THE ROSS GROUP MAY EXTEND THE LIABILITY OF THE ROSS GROUP AS SET FORTH HEREIN.





AMERICAS

U.S.A.

ROSS CONTROLS

+1-248-764-1800

sales@rosscontrols.com

www.rosscontrols.com

Customer Service

1-800-GET-ROSS (438-1800)

Technical Service

1-888-TEK-ROSS (835-7677)

Canada

ROSS CANADA

+1-416-251-7677

sales@rosscanada.com

www.rosscanada.com

6077170 CANADA INC.

AN INDEPENDENT REPRESENTATIVE

Brazil

ROSS BRASIL

+55-11-4335-2200

vendas@rosscontrols.com

www.rosscontrols.com.br

EUROPE

Germany

ROSS EUROPA GmbH

+49-6103-7597-100

sales@rosseuropa.com

www.rosseuropa.com

United Kingdom

ROSS UK Ltd.

+44 (0)1254 872277

sales.uk@rosscontrols.com

www.rossuk.co.uk

France

ROSS FRANCE SAS

+33-1-49-45-65-65

sales@rossfrance.com

www.rossfrance.com

ASIA & PACIFIC

Japan

ROSS ASIA K.K.

+81-42-778-7251

custsvc.ra@rosscontrols.com

www.rossasia.co.jp

India

ROSS CONTROLS INDIA Pvt. Ltd.

+91-44-2624-9040

sales.ri@rosscontrols.com

www.rosscontrols.com

China

ROSS CONTROLS (CHINA) Ltd.

+86-21-6915-7942

sales.cn@rosscontrols.com

www.rosscontrolschina.com

ROSS CONTROLS COMPANIES

U.S.A.

AUTOMATIC VALVE

+1-248-474-6700

avc@automaticvalve.com

www.automaticvalve.com

Germany

manufactIS

+49 (0)201 316843-0

info@manufactis.net

www.manufactis.net

U.S.A.

ROSS DECCO

+1-248-764-1800

decco.sales@rosscontrols.com

www.rossdecco.com United King-

dom

ROSS PNEUMATROL

+44 (0)1254 872277

sales@pneumatrol.com

www.pneumatrol.com

Full-Service Global Locations

There are ROSS Distributors Throughout the World

To meet your requirements across the globe, ROSS distributors are located throughout the world. Through ROSS or its distributors, guidance is available for the selection of ROSS products, both for those using fluid power components for the first time and those designing complex systems.

Other literature is available for engineering, maintenance, and service requirements.

If you need products or specifications not shown in this catalog, please visit ROSS' website, contact ROSS or your ROSS distributor. The ROSS Support Team will be happy to assist you in selecting the best product for your application.

For a current list of countries and local distributors, visit ROSS' at www.rosscontrols.com.