

AIR LINE LUBRICATORS

LUBRICATOR FUNCTION

Air line lubricators are designed to introduce atomized oil into the air line so that downstream mechanisms can be adequately lubricated. Lubricators should be adjusted so that the minimum amount of oil to lubricate the equipment is used. Excess oil will simply be blown into the atmosphere and pollute the environment.

There are two basic designs used in Master Pneumatic lubricators: sight-feed design and wick-feed design. Illustrations of these two types of assembly are shown on the facing page.

SIGHT-FEED LUBRICATORS

Air flows through a flexible-vane automatic flow sensor that creates a small pressure differential between the air passage and the oil reservoir. This differential causes oil to move up a riser tube, through an adjustable metering valve, and then to drip into a transparent dome and the air stream. This oil is “atomized” by the air stream, and carried down the air line to the points of lubrication.

Sight-feed lubricators are easy to adjust, and an indicator on the sight dome measures the amount of oil dispensed. The adjusting knob can be removed to make the lubricator “tamper-resistant.”

All working parts are in an easily replaceable cartridge.

Note: Not recommended for valve and cylinder circuits (see **INJECTION LUBRICATORS** section).

WICK-FEED LUBRICATORS

In a wick-feed lubricator one end of a porous bronze wick is saturated with oil in the reservoir. Capillary action causes the oil to travel up the wick. Oil is stripped off the upper portion of the wick by the air flow, and maintains a constant oil-to-air ratio. This ratio can be varied by manual adjustment. Units will not shut off, even with dirt and moisture in the reservoir. However, air must be shut off when filling the reservoirs of these models.

MODULAR or INLINE MOUNTING

SENTRY, GUARDSMAN, SERIES 350, SERIES 380, and **Full-Size VANGUARD** lubricators are of modular design. They are connected to other units by special modular connectors which seal the faces between units. They may also be inline mounted with pipe nipples.

MINIATURE and **High-Flow VANGUARD** lubricators are inline mounted only.

GUIDE to AIR LINE LUBRICATORS

For precision controlled lubrication see **INJECTION LUBRICATORS** section.

Regulator Series	Modular Construction	Port Sizes								Pages	
		1/8	1/4	3/8	1/2	3/4	1	1-1/4	1-1/2		2
SENTRY †											
Wick-Feed L10 models	yes	X	X								230-234
MINIATURE											
Wick-Feed L50, L50Y models	no	X	X								232-233
GUARDSMAN											
Sight-Feed L60D models	yes		X	X	X						234-235
GUARDSMAN II											
Sight-Feed BL70D models	yes		X	X	X						236-237
SERIES 350											
L350D models	yes		X	X	X						238-239
Full-Size VANGUARD											
Sight-Feed L28D models	yes		X	X	X	X					240-241
Wick-Feed L28W models	yes		X	X	X	X					242-243
Full-Size SERIES 380											
Sight-Feed L380D models	yes			X	X	X					244-245
High-Flow VANGUARD											
Sight-Feed L29D models	no					X	X	X	X		246-247
Wick-Feed L100 models	no					X	X				248-249
Sight-Feed BL237 models	no					X	X	X	X		250-251

† Also available with quick-connect tube fittings up to 10 mm.



บริษัท ฟลูเทค จำกัด
FLU-TECH CO.,LTD

845/3-4 หมู่ 3 ถ.เทพารักษ์ ต.เทพารักษ์ อ.เมือง จ.สมุทรปราการ 10270
845/3-4 Thepharak RD., T.Thepharak, A.Muang, Samutprakarn 10270 THAILAND
Tel. 0 2384 6060, Fax 0 2384 5701, Email : sales@flutech.co.th, www.flutech.co.th

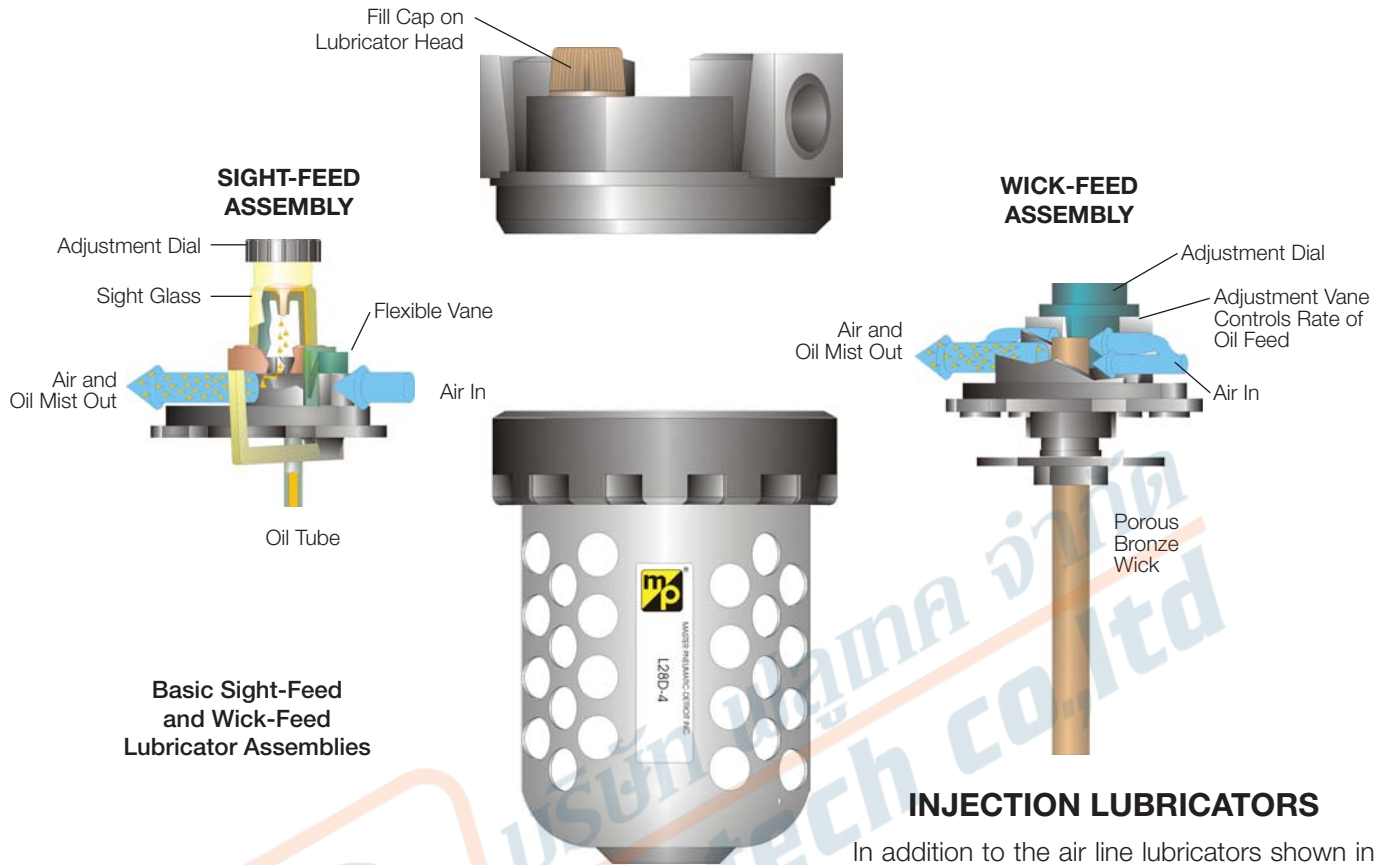

Basic Sight-Feed and Wick-Feed Lubricator Assemblies

INJECTION LUBRICATORS

In addition to the air line lubricators shown in this section, see the next section, **INJECTION LUBRICATORS**, for more specialized lubrication units.

SENTRY LUBRICATORS

Port sizes 1/8 and 1/4 or fittings for tubing up to 10 mm. Wick-feed design and modular assembly. Made of durable, corrosion-resistant acetal. Polycarbonate or aluminum bowl. Air flow to 25 scfm (12 l/s). 2-Ounce (60-ml) bowl capacity.

MINIATURE LUBRICATORS

Port sizes 1/8 and 1/4. Wick-feed design and inline mounting only. Aluminum head with polycarbonate or aluminum bowl. Air flow to 25 scfm (12 l/s). 2-Ounce (60-ml) bowl capacity. Special low-flow models are designed to deliver oil in situations where air flow is less than 1 scfm.

GUARDSMAN LUBRICATORS

Series L60D with port sizes 1/4, 3/8, 1/2. Sight-feed design and modular or inline mounting. Polycarbonate bowl with zinc die-cast shatterguard or zinc bowl. Air flow to 110 scfm (52 l/s). 4-Ounce (120-ml) bowl capacity.

GUARDSMAN II LUBRICATORS

Series BL70D with port sizes 1/4, 3/8, 1/2. Sight-feed design and modular or inline mounting. Zinc head. Aluminum bowl with clear nylon sight glass. Air flow to

110 scfm (52 l/s). 6-Ounce (180-ml) and 10-ounce (300-ml) bowl capacities.

SERIES 380 LUBRICATORS

Port sizes 3/8, 1/2, 3/4. Sight-feed design and modular or inline mounting. Zinc head. Aluminum bowl with clear nylon sight glass. Air flow to 170 scfm (80 l/s). 9-Ounce (270-ml) and 15-ounce (450-ml) bowls.

FULL-SIZE VANGUARD LUBRICATORS

Port sizes 1/4, 3/8, 1/2. Either wick-feed or sight-feed design; modular or inline mounting. Air flows up to 140 scfm (66 l/s). Zinc head. Polycarbonate bowl with steel shatterguard or zinc bowl. 8-Ounce (240-ml) or 20-ounce (600-ml) zinc bowls available.

HIGH-FLOW VANGUARD LUBRICATORS

Port sizes 3/4 to 1-1/2. Either wick-feed or sight-feed design; inline mounting only. Air flows up to 500 scfm (235 l/s). Aluminum head. Polycarbonate bowl with steel shatterguard or aluminum bowl. 16-Ounce (480-ml), 35-ounce (1030-ml), or 62-ounce (1830-ml) bowls.



SENTRY Modular Lubricators

L10 Models Port Sizes: 1/8, 1/4; Tube Fittings



Model Shown: L10-2

- ◆ Modular assembly and mounting.
- ◆ Threaded ports or quick-connect fittings for tubing up to 10 mm in diameter.
- ◆ Wick-feed design.
- ◆ **NPTF** port threads; optional **BSPP** threads.

SPECIFICATIONS

Ambient/Media Temperature:

40° to 125°F (4° to 52°C).

Body: Acetal.

Bowl: 2-Ounce (60-ml) capacity polycarbonate plastic; optional aluminum bowl.

Fluid Media: Compressed air.

Inlet Pressure: 150 psig (10 bar) maximum.

Oil Adjustment: External, no shutoff.

Seals: Nitrile.

FLOW CHART

Inlet Pressure: 100 psig (7 bar)

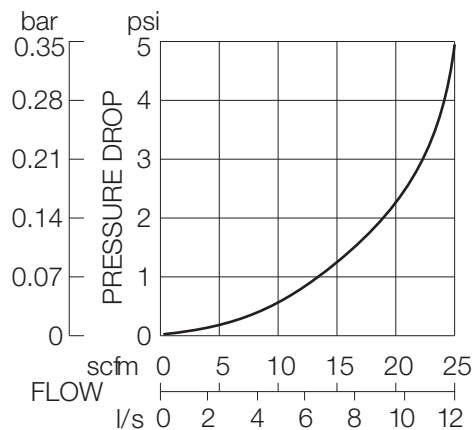

Minimum Flow: 1 scfm (0.47 l/s)



บริษัท ฟลูเทค จำกัด
FLU-TECH CO.,LTD

845/3-4 หมู่ 3 ถ.เทพารักษ์ ต.เทพารักษ์ อ.เมือง จ.สมุทรปราการ 10270
845/3-4 Thepharak RD., T.Thepharak, A.Muang, Samutprakarn 10270 THAILAND
Tel. 0 2384 6060, Fax 0 2384 5701, Email : sales@flutech.co.th, www.flutech.co.th

DIMENSIONS inches (mm)

Ports	A	B †	C	Depth	Weight lb (kg)
No Port	1.7 (43)	3.6 (91)	0.9 (22)	1.8 (45)	0.17 (0.08)
1/8, 1/4	3.0 (76)	3.6 (91)	0.9 (22)	1.8 (45)	0.37 (0.17)
Models below have quick-connect fittings for tubing.					
1/4	3.4 (86)	3.6 (91)	0.9 (22)	1.8 (45)	0.37 (0.17)
3/8	3.9 (99)	3.6 (91)	0.9 (22)	1.8 (45)	0.37 (0.17)
4 mm	3.4 (86)	3.6 (91)	0.9 (22)	1.8 (45)	0.37 (0.17)
6 mm	3.4 (86)	3.6 (91)	0.9 (22)	1.8 (45)	0.37 (0.17)
8 mm	3.4 (86)	3.6 (91)	0.9 (22)	1.8 (45)	0.37 (0.17)
10 mm	3.9 (99)	3.6 (91)	0.9 (22)	1.8 (45)	0.37 (0.17)

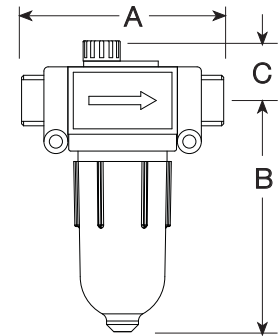

† Dimension is for plastic bowl; metal bowl is 3.8 (97).

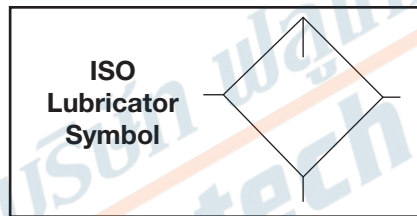

ORDERING INFORMATION

Change the letters in the sample model number below to specify the lubricator you want.

L10 P - 2 X Y W

<p>BOWL TYPE</p> <p>Plastic L10</p> <p>Metal..... BL10</p>	<p>MOUNTING HOLE LOCATION</p> <p>Bottom mount (Standard) Leave Blank</p> <p>Top mountP</p>	<p>INLET PORT SIZE</p> <p>No Inlet and Outlet Ports. Leave blank</p> <p>Threaded:</p> <p>1/8 NPTF 1</p> <p>1/4 NPTF 2</p> <p>Fittings for Tubing:</p> <p>1/4 04</p> <p>3/8 06</p> <p>4 mm M4</p> <p>6 mm M6</p> <p>8 mm M8</p> <p>10 mm M10</p>	<p>PORT TYPE</p> <p>As specified in INLET PORT ... Leave Blank</p> <p>BSPP threads on both ports ...W</p> <p>OPTIONS</p> <p>None Leave Blank</p> <p>Quick-fill Q-cap..... Q</p> <p>OUTLET PORT SIZE</p> <p>Same as inlet port Leave Blank</p> <p>Threaded:</p> <p>1/8 NPTF 1</p> <p>1/4 NPTF 2</p> <p>Fittings for Tubing:</p> <p>1/4 04</p> <p>3/8 06</p> <p>4 mm M4</p> <p>6 mm M6</p> <p>8 mm M8</p> <p>10 mm M10</p>
---	---	---	--



บริษัท ฟลูเทค จำกัด
FLU-TECH CO.,LTD

845/3-4 หมู่ 3 ถ.เทพารักษ์ ต.เทพารักษ์ อ.เมือง จ.สมุทรปราการ 10270
845/3-4 Thepharak RD., T.Thepharak, A.Muang, Samutprakarn 10270 THAILAND
Tel. 0 2384 6060, Fax 0 2384 5701, Email : sales@flutech.co.th, www.flutech.co.th

MINIATURE Lubricators

L50, L50-Y Models Port Sizes: 1/8, 1/4



Model Shown: L50-2

- ◆ Inline mounting.
- ◆ High-strength polycarbonate plastic bowl; optional aluminum bowl.
- ◆ Low-flow models (L50Y) are designed to deliver oil in extremely low-flow (less than 1 scfm) situations.
- ◆ Wick-feed design in both standard-flow and low-flow lubricators.
- ◆ Internal tamper-proof adjustment.
- ◆ NPTF port threads; optional BSPP threads.

SPECIFICATIONS

Ambient/Media Temperature:

Plastic bowl: 40° to 125°F (4° to 52°C).
Metal bowl: 40° to 150°F (4° to 66°C).

Body: Aluminum.

Bowl: 2-Ounce (60-ml) capacity polycarbonate plastic; optional aluminum bowl.

Fluid Media: Compressed air.

Inlet Pressure:

Plastic bowl: 150 psig (10 bar) maximum.
Metal bowl: 200 psig (14 bar) maximum.

Oil Adjustment: Internal, tamper-proof.

Seals: Nitrile.

FLOW CHARTS

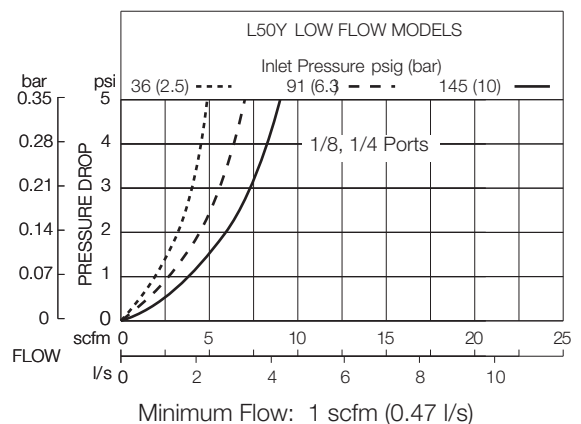
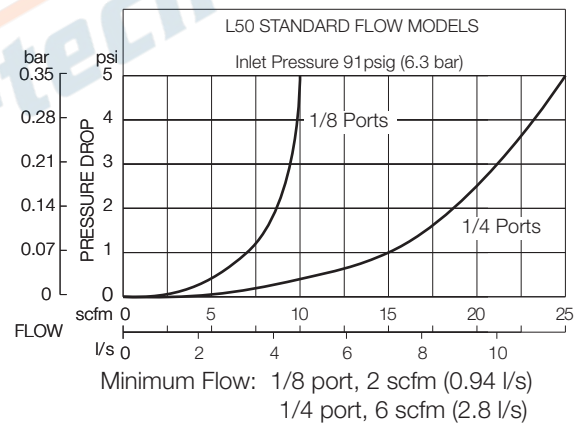

บริษัท ฟลูเทค จำกัด
FLU-TECH CO.,LTD

845/3-4 หมู่ 3 ถ.เทพารักษ์ ต.เทพารักษ์ อ.เมือง จ.สมุทรปราการ 10270
845/3-4 Thepharak RD., T.Thepharak, A.Muang, Samutprakarn 10270 THAILAND
Tel. 0 2384 6060, Fax 0 2384 5701, Email : sales@flutech.co.th, www.flutech.co.th

DIMENSIONS inches (mm)

Bowl	A	B	C	Depth	Weight
					lb (kg)
Plastic	1.6 (41)	3.6 (91)	0.7 (17)	1.6 (41)	0.21 (0.10)
Metal	1.6 (41)	3.8 (97)	0.7 (17)	1.6 (41)	0.21 (0.10)

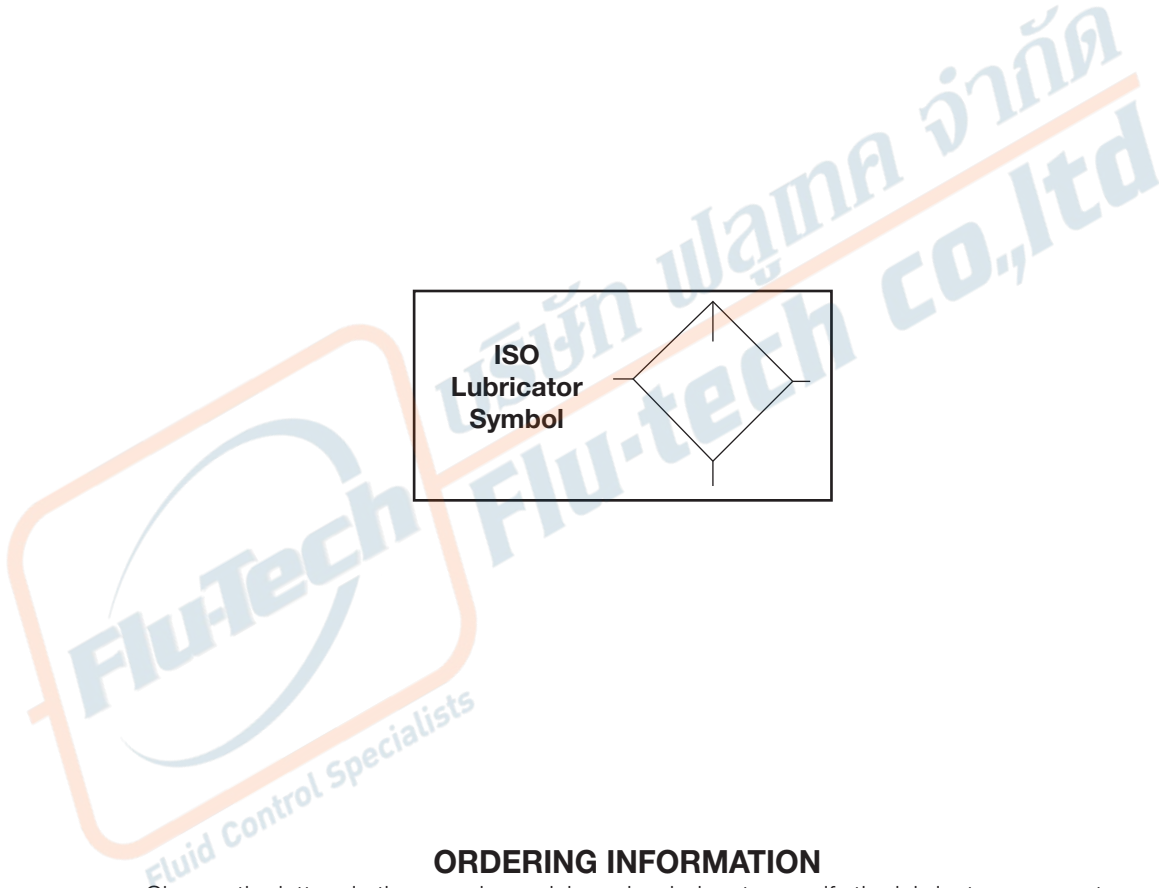
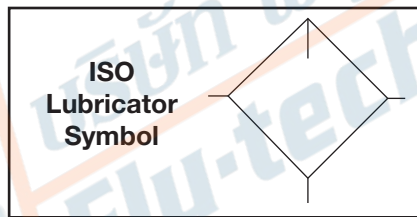
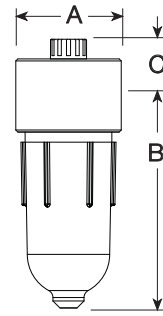

ORDERING INFORMATION

Change the letters in the sample model number below to specify the lubricator you want.

L50 - 2 X W

BOWL TYPE

- Plastic (standard flow).....L50
- Plastic (low flow)L50-Y
- Metal (standard flow)BL50
- Metal (low flow).....BL50-Y

PORT SIZE

- 1/8 NPTF..... 1
- 1/4 NPTF.....2

PORT TYPE

- NPTF threads Leave Blank
- BSPB threads W

OPTIONS: *(More than one option can be chosen. Add in alphabetical order)*

- None Leave Blank
- Quick-fill Q-cap Q
- Tapped modified head to T
allow 50-01 bracket assy.



บริษัท ฟลูเทค จำกัด
FLU-TECH CO.,LTD

845/3-4 หมู่ 3 ถ.เทพารักษ์ ต.เทพารักษ์ อ.เมือง จ.สมุทรปราการ 10270
845/3-4 Thepharak RD., T.Thepharak, A.Muang, Samutprakarn 10270 THAILAND
Tel. 0 2384 6060, Fax 0 2384 5701, Email : sales@flutech.co.th, www.flutech.co.th

GUARDSMAN Modular Lubricators

L60D Models Port Sizes: 1/4, 3/8, 1/2



Model Shown: L60D-2

- ◆ Modular or inline mounting.
- ◆ High-strength polycarbonate plastic bowl with zinc shatterguard. Optional zinc bowl.
- ◆ Sight-feed design.
- ◆ External tamper-resistant adjustment.
- ◆ NPTF port threads; optional BSPP threads.

SPECIFICATIONS

Ambient/Media Temperature:

Plastic bowl: 40° to 125°F (4° to 52°C).

Metal bowl: 40° to 175°F (4° to 79°C).

Body: Zinc.

Bowl: 4-Ounce (120-ml) polycarbonate plastic with zinc shatterguard; optional zinc bowl.

Fluid Media: Compressed air.

Inlet Pressure:

Plastic bowl: 150 psig (10 bar) maximum.

Metal bowl: 200 psig (14 bar) maximum.

Oil Adjustment: External, tamper-resistant.

Sight Dome: Nylon.

Seals: Nitrile.

FLOW CHART

Inlet Pressure: 100 psig (7 bar)

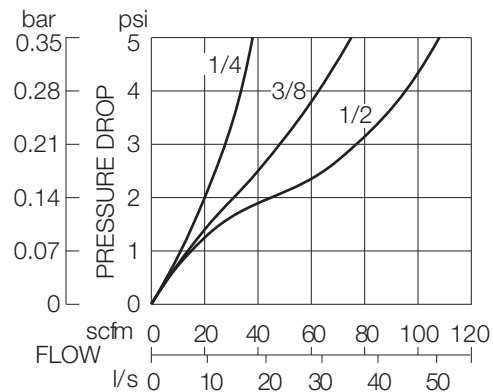

Minimum Flow: 2 scfm (0.94 l/s)



บริษัท ฟลูเทค จำกัด
FLU-TECH CO.,LTD

845/3-4 หมู่ 3 ถ.เทพารักษ์ ต.เทพารักษ์ อ.เมือง จ.สมุทรปราการ 10270

845/3-4 Thepharak RD., T.Thepharak, A.Muang, Samutprakarn 10270 THAILAND
Tel. 0 2384 6060, Fax 0 2384 5701, Email : sales@flutech.co.th, www.flutech.co.th

DIMENSIONS inches (mm)

Bowl	A	B	C	Depth	Weight
					lb (kg)
Plastic	2.7 (67)	4.1 (103)	1.8 (46)	2.4 (60)	1.06 (0.48)
Metal	2.7 (67)	4.1 (103)	1.8 (46)	2.4 (60)	1.50 (0.68)

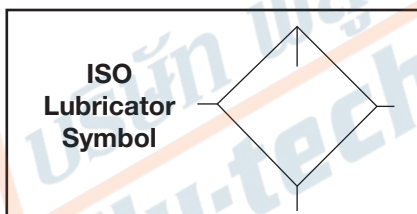
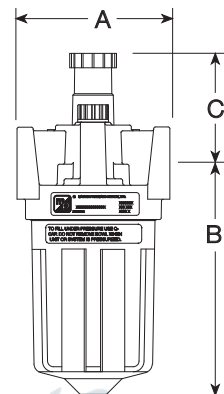

ORDERING INFORMATION

Change the letters in the sample model number below to specify the lubricator you want.

L60D - 2 Y W			
BOWL TYPE	_____	PORT TYPE	
Plastic	L60D	NPTF threads	Leave Blank
Metal.....	BL60D	BSPP threads	W
PORT SIZE	_____	OPTIONS	
1/4 NPTF.....	2	None	Leave Blank
3/8 NPTF.....	3	Quick-fill Q-cap.....	Q
1/2 NPTF.....	4		



บริษัท ฟลูเทค จำกัด
FLU-TECH CO.,LTD

845/3-4 หมู่ 3 ถ.เทพารักษ์ ต.เทพารักษ์ อ.เมือง จ.สมุทรปราการ 10270
845/3-4 Thepharak RD., T.Thepharak, A.Muang, Samutprakarn 10270 THAILAND
Tel. 0 2384 6060, Fax 0 2384 5701, Email : sales@flutech.co.th, www.flutech.co.th

GUARDSMAN II Modular Lubricators

BL70D Models Port Sizes: 1/4, 3/8, 1/2



Model Shown: BL70D-2

- ◆ Modular or inline mounting.
- ◆ Aluminum bowl with clear nylon sight glass. Bowl can be rotated for easy readability. Optional extended bowl.
- ◆ Sight-feed design.
- ◆ External adjusting knob; removable for tamper resistance.
- ◆ NPTF port threads; optional BSPP threads.

SPECIFICATIONS

Ambient/Media Temperature:

40° to 175°F (4° to 79°C).

Body: Zinc.

Bowl:

6-Ounce (180-ml) capacity aluminum bowl with clear nylon sight glass. Bowl can be rotated for easy readability. Optional 10-ounce (300-ml) extended aluminum bowl.

Bowl Ring: Nylon.

Fluid Media: Compressed air.

Inlet Pressure:

200 psig (14 bar) maximum.

Oil Adjustment: External, tamper-resistant.

Seals: Nitrile.

Sight Dome: Nylon.

FLOW CHART

Inlet Pressure: 100 psig (7 bar)

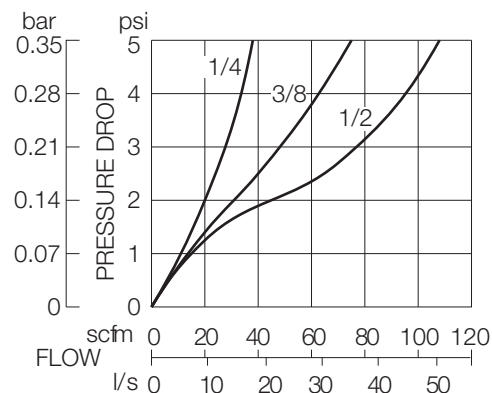

Minimum Flow: 2 scfm (0.94 l/s)



บริษัท ฟลูเทค จำกัด
FLU-TECH CO.,LTD

845/3-4 หมู่ 3 ถ.เทพารักษ์ ต.เทพารักษ์ อ.เมือง จ.สมุทรปราการ 10270

845/3-4 Thepharak RD., T.Thepharak, A.Muang, Samutprakarn 10270 THAILAND
Tel. 0 2384 6060, Fax 0 2384 5701, Email : sales@flutech.co.th, www.flutech.co.th

DIMENSIONS inches (mm)

Bowl	A	B	C	Depth	Weight lb (kg)
Standard	2.7 (67)	5.9 (151)	1.8 (46)	2.4 (60)	1.25 (0.57)
Extended	2.7 (67)	8.9 (227)	1.8 (46)	2.4 (60)	1.50 (0.68)

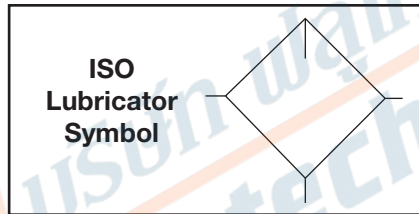
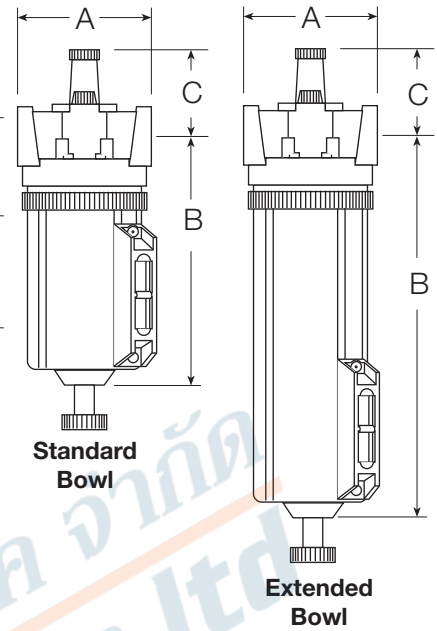

ORDERING INFORMATION

Change the letters in the sample model number below to specify the lubricator you want.

BL 70D - 2 Y W

BOWL SIZE

Standard 6-ounce bowl 70D
 Extended 10-ounce bowl 70DH

PORT SIZE

1/4 NPTF 2
 3/8 NPTF 3
 1/2 NPTF 4

PORT TYPE

NPTF threads Leave Blank
 BSPP threads W

OPTIONS

None Leave Blank
 Quick-fill Q-cap Q



บริษัท ฟลูเทค จำกัด
FLU-TECH CO.,LTD

845/3-4 หมู่ 3 ถ.เทพารักษ์ ต.เทพารักษ์ อ.เมือง จ.สมุทรปราการ 10270
 845/3-4 Thepharak RD., T.Thepharak, A.Muang, Samutprakarn 10270 THAILAND
 Tel. 0 2384 6060, Fax 0 2384 5701, Email : sales@flutech.co.th, www.flutech.co.th

SERIES 350 Modular Lubricators

L350D Models

Port Sizes: 1/4, 3/8, 1/2



Model Shown: L350D-3C1

Available Color Caps

Yellow
(standard)



Red
(optional)



Blue
(optional)



Grey
(optional)



SPECIFICATIONS

Ambient/Media Temperature:

Plastic bowl: 40° to 125°F (4° to 52°C)

Metal bowl: 40° to 175°F (4° to 79°C)

Body:

Zinc.

Bowl: 5.1-Ounce (151-ml) capacity polycarbonate plastic with nylon shatterguard; optional 6.0 ounce (177-ml) aluminum bowl with clear nylon sight glass. Optional 10-ounce (300-ml) extended aluminum bowl with clear nylon sight glass.

Cap Color: yellow, Optional red, blue and grey.

Fluid Media: Compressed air.

Inlet Pressure:

Plastic bowl: 150 psig (10 bar) maximum.

Metal bowl: 250 psig (17 bar) maximum.

Oil Adjustment: External; tamper resistant.

Seals: Nitrile.

Sight-Feed Dome: Nylon.

- ◆ Modular or inline mounting
- ◆ Sight feed design; transparent dome to show oil delivery.
- ◆ External oil delivery adjusting knob, removable for tamper resistance.
- ◆ Polycarbonate bowl with shatterguard; optional metal bowl with nylon sight glass.
- ◆ Inlet pressure rated at 250 psig (17 bar) with metal bowls up to 175° F. (79° C.).
- ◆ Color caps available for visual management systems. (Blue, red, yellow and grey). Consult factory for custom colors.
- ◆ Front mounted modular clamping design with encapsulated screws.
- ◆ Compatible with modular 380 series of products.
- ◆ NPTF port threads; optional BSPP threads.

FLOW CHARTS

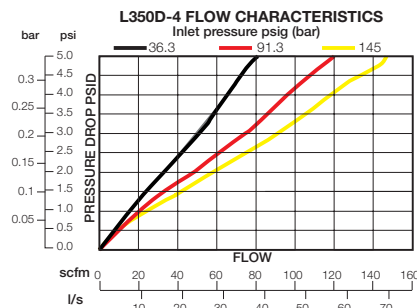
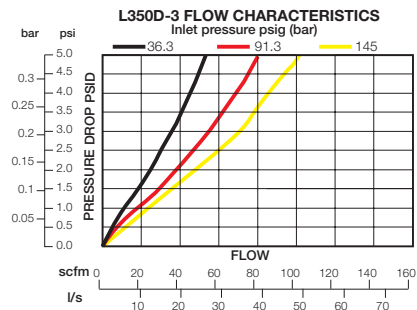
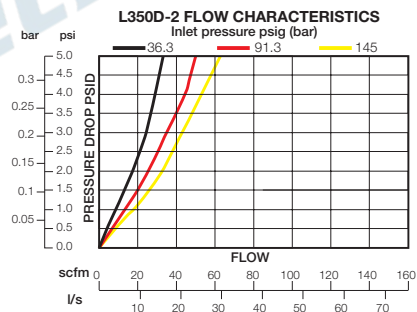

บริษัท ฟลูเทค จำกัด
FLU-TECH CO.,LTD

845/3-4 หมู่ 3 ถ.เทพารักษ์ ต.เทพารักษ์ อ.เมือง จ.สมุทรปราการ 10270

845/3-4 Thepharak RD., T.Thepharak, A.Muang, Samutprakarn 10270 THAILAND
Tel. 0 2384 6060, Fax 0 2384 5701, Email : sales@flutech.co.th, www.flutech.co.th

DIMENSIONS inches (mm)

Bowl	A	B †	C	Depth	Weight lb (kg)
Std plastic	3.0 (76.2)	4.72 (119.9)	2.21 (56.1)	2.51 (63.8)	1.30 (0.59)
Std metal	3.0 (76.2)	6.02 (152.9)	2.21 (56.1)	2.76 (70.1)	1.42 (0.65)
Ext metal	3.0 (76.2)	9.37 (238)	2.21 (56.1)	2.76 (70.1)	1.54 (0.70)

† **Bowl (standard) removal clearance:** add 3.1 (79)
 † **Bowl (extended) removal clearance:** add 6.1 (155)

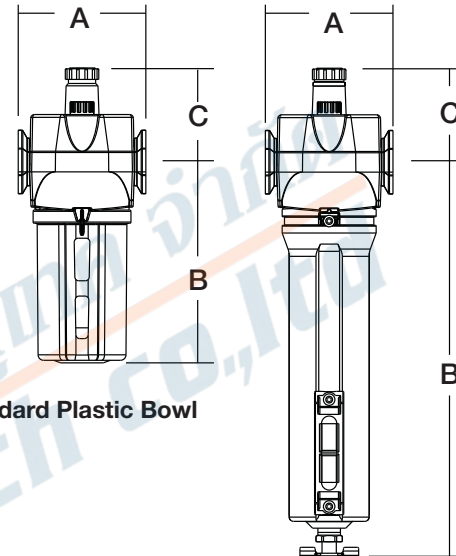
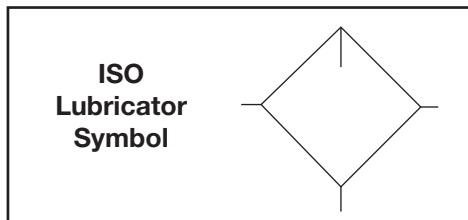

Standard Plastic Bowl

Extended Metal Bowl

ORDERING INFORMATION

Change the letters in the sample model number below to specify the lubricator you want.

BL 350D H - 3 C1 W

BOWL TYPE

Plastic bowl L
 Metal bowl BL

BOWL TYPE

Standard length Leave Blank
 Extended bowl length H
 (Must be used with metal bowl
 option shown in BOWL and
 DRAIN TYPE)

PORT TYPE

1/4 NPTF 2
 3/8 NPTF 3
 1/2 NPTF 4

PORT TYPE

NPTF threads Leave blank
 BSPF threads W

OPTIONS

Cap color
 MP yellow (standard) C1
 Red C2
 Mid blue C3
 Grey Leave blank



บริษัท ฟลูเทค จำกัด
FLU-TECH CO.,LTD

845/3-4 หมู่ 3 ถ.เทพารักษ์ ต.เทพารักษ์ อ.เมือง จ.สมุทรปราการ 10270
 845/3-4 Thepharak RD., T.Thepharak, A.Muang, Samutprakarn 10270 THAILAND
 Tel. 0 2384 6060, Fax 0 2384 5701, Email : sales@flutech.co.th, www.flutech.co.th

Full-Size VANGUARD Modular Lubricators

L28D Models Port Sizes: 1/4, 3/8, 1/2, 3/4



Model Shown: L28D-3

- ◆ Modular or inline mounting.
- ◆ High-strength polycarbonate plastic bowl with steel shatterguard. Optional zinc bowl with sight glass.
- ◆ Sight-feed design.
- ◆ Optional 20-ounce extended bowl.
- ◆ External adjusting knob; removable for tamper resistance.
- ◆ NPTF port threads; optional BSPP threads.

SPECIFICATIONS

Ambient/Media Temperature:

Plastic bowl: 40° to 125°F (4° to 52°C).

Metal bowl: 40° to 175°F (4° to 79°C).

Body: Zinc.

Bowl: 8-Ounce (240-ml) capacity polycarbonate plastic with steel shatterguard; optional zinc bowl with sight glass. Optional 20-ounce (600-ml) extended polycarbonate or zinc bowl.

Bowl Ring: Aluminum.

Fluid Media: Compressed air.

Inlet Pressure:

Plastic bowl: 150 psig (10 bar) maximum.

Metal bowl: 200 psig (14 bar) maximum.

Oil Adjustment: External, tamper-resistant.

Seals: Nitrile.

Sight Dome: Nylon.

FLOW CHART

Inlet Pressure: 100 psig (7 bar)

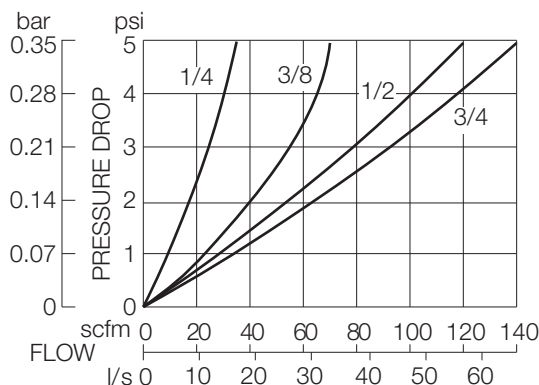

Minimum Flow: 2 scfm (0.94 l/s)



บริษัท ฟลูเทค จำกัด
FLU-TECH CO.,LTD

845/3-4 หมู่ 3 ถ.เทพารักษ์ ต.เทพารักษ์ อ.เมือง จ.สมุทรปราการ 10270

845/3-4 Thepharak RD., T.Thepharak, A.Muang, Samutprakarn 10270 THAILAND
Tel. 0 2384 6060, Fax 0 2384 5701, Email : sales@flutech.co.th, www.flutech.co.th

DIMENSIONS inches (mm)

Bowl	A	B	C	Depth	Weight lb (kg)
Standard Plastic	3.5 (89)	5.2 (132)	1.3 (32)	3.5 (89)	2.06 (0.94)
Extended Plastic	3.5 (89)	9.7 (246)	1.3 (32)	3.5 (89)	3.75 (1.70)
Standard Metal	3.5 (89)	5.3 (135)	1.3 (32)	3.5 (89)	2.90 (1.32)
Extended Metal	3.5 (89)	9.8 (249)	1.3 (32)	3.5 (89)	4.65 (2.11)

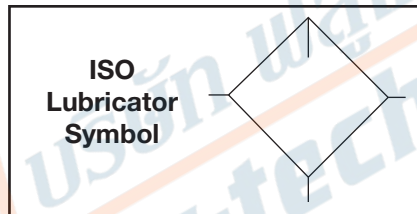
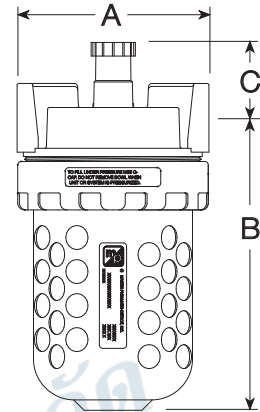

ORDERING INFORMATION

Change the letters in the sample model number below to specify the lubricator you want.

L28D - 2 Y W

BOWL TYPE

8-Ounce plastic L28D
 8-Ounce metal BL28D
 20-Ounce plastic L28DH
 20-Ounce metal BL28DH

PORT SIZE

1/4 NPTF 2
 3/8 NPTF 3
 1/2 NPTF 4
 3/4 NPTF 6

PORT TYPE

NPTF threads Leave Blank
 BSPP threads W

OPTIONS

None Leave Blank
 Quick-fill Q-cap Q



บริษัท ฟลูเทค จำกัด
FLU-TECH CO.,LTD

845/3-4 หมู่ 3 ถ.เทพารักษ์ ต.เทพารักษ์ อ.เมือง จ.สมุทรปราการ 10270
 845/3-4 Thepharak RD., T.Thepharak, A.Muang, Samutprakarn 10270 THAILAND
 Tel. 0 2384 6060, Fax 0 2384 5701, Email : sales@flutech.co.th, www.flutech.co.th

Full-Size VANGUARD Modular Lubricators

L28W Models Port Sizes: 1/4, 3/8, 1/2, 3/4



Model Shown: L28W-4

- ◆ Modular or inline mounting.
- ◆ High-strength polycarbonate plastic bowl with steel shatterguard. Optional zinc bowl.
- ◆ Wick-feed design.
- ◆ External adjusting knob.
- ◆ NPTF port threads; optional BSPP threads.

SPECIFICATIONS

Ambient/Media Temperature:

Plastic bowl: 40° to 125°F (4° to 52°C).

Metal bowl: 40° to 175°F (4° to 79°C).

Adjusting Knob: Acetal.

Body: Zinc.

Bowl: 8-Ounce (240-ml) capacity polycarbonate plastic with steel shatterguard. Optional zinc bowl.

Bowl Ring: Aluminum.

Fluid Media: Compressed air.

Inlet Pressure:

Plastic bowl: 150 psig (10 bar) maximum.

Metal bowl: 200 psig (14 bar) maximum.

Oil Adjustment: External.

Seals: Nitrile.

FLOW CHART

Inlet Pressure: 100 psig (7 bar)

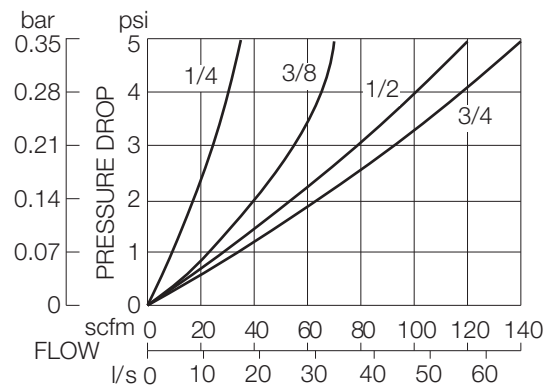

Minimum Flow: 6 scfm (2.8 l/s)



บริษัท ฟลูเทค จำกัด
FLU-TECH CO.,LTD

845/3-4 หมู่ 3 ถ.เทพารักษ์ ต.เทพารักษ์ อ.เมือง จ.สมุทรปราการ 10270

845/3-4 Thepharak RD., T.Thepharak, A.Muang, Samutprakarn 10270 THAILAND
Tel. 0 2384 6060, Fax 0 2384 5701, Email : sales@flutech.co.th, www.flutech.co.th

DIMENSIONS inches (mm)

Bowl	A	B	C	Depth	Weight lb (kg)
Plastic	3.5 (89)	5.2 (132)	0.7 (17)	3.5 (89)	2.25 (1.02)
Metal	3.5 (89)	5.3 (135)	0.7 (17)	3.5 (89)	2.85 (1.30)

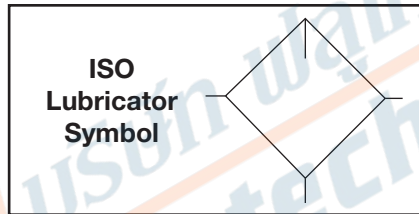
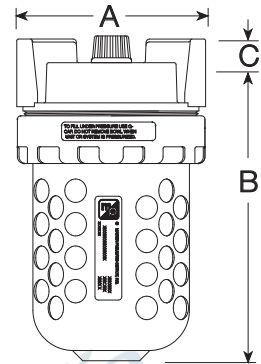

ORDERING INFORMATION

Change the letters in the sample model number below to specify the lubricator you want.

L28W - 2 Y W

BOWL TYPE

- 8-Ounce plastic L28W
- 8-Ounce metal BL28W

PORT SIZE

- 1/4 NPTF 2
- 3/8 NPTF 3
- 1/2 NPTF 4
- 3/4 NPTF 6

PORT TYPE

- NPTF threads Leave Blank
- BSPP threads W

OPTIONS

- None Leave Blank
- Quick-fill Q-cap Q



บริษัท ฟลูเทค จำกัด
FLU-TECH CO.,LTD

845/3-4 หมู่ 3 ถ.เทพารักษ์ ต.เทพารักษ์ อ.เมือง จ.สมุทรปราการ 10270
845/3-4 Thepharak RD., T.Thepharak, A.Muang, Samutprakarn 10270 THAILAND
Tel. 0 2384 6060, Fax 0 2384 5701, Email : sales@flutech.co.th, www.flutech.co.th

Full-Size SERIES 380 Modular Lubricators

L380D Models Port Sizes: 3/8, 1/2, 3/4

Available Color Caps

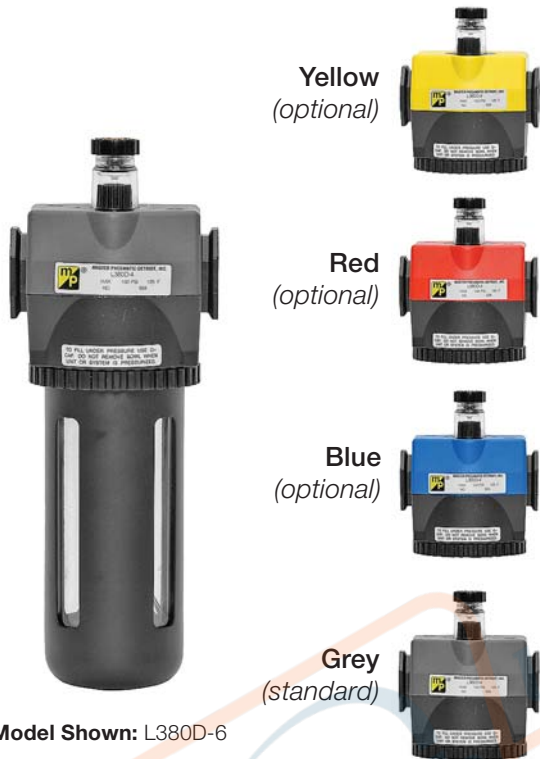

Model Shown: L380D-6

SPECIFICATIONS

Ambient/Media Temperature:

Plastic bowl: 40° to 125°F (4° to 52°C).

Metal bowl: 40° to 175°F (4° to 79°C).

Body: Zinc.

Bowl: 9-Ounce (270-ml) capacity polycarbonate plastic with steel shatterguard; optional aluminum bowl with clear nylon sight glass.

Optional 15-ounce (450-ml) extended aluminum bowl with two clear nylon sight glasses.

Bowl Ring: Nylon.

Cap Color: Grey. Yellow, red, and blue optional.

Fluid Media: Compressed air.

Inlet Pressure:

Plastic bowl: 150 psig (10 bar).

Metal bowl: 200 psig (14 bar).

Oil Adjustment: External; tamper resistant.

Seals: Nitrile.

Sight-Feed Dome: Nylon.

- ◆ Modular or inline mounting.
- ◆ Sight-feed design; transparent dome shows how much oil is being dispensed.
- ◆ External adjusting knob, removable for tamper resistance.
- ◆ Polycarbonate plastic bowl with steel shatter-guard; optional aluminum bowl with sight glass.
- ◆ Optional extended metal bowl.
- ◆ All working parts can be replaced with a single service cartridge.
- ◆ NPTF port threads; optional BSPP threads.
- ◆ All Optional low level switch.

FLOW CHARTS

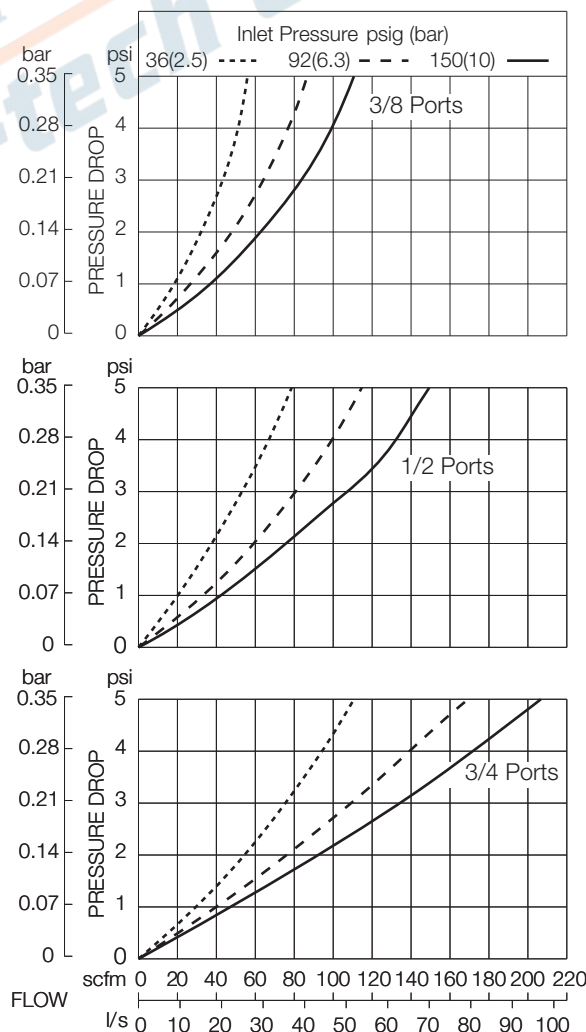

บริษัท ฟลูเทค จำกัด
FLU-TECH CO.,LTD

845/3-4 หมู่ 3 ถ.เทพารักษ์ ต.เทพารักษ์ อ.เมือง จ.สมุทรปราการ 10270

845/3-4 Thepharak RD., T.Thepharak, A.Muang, Samutprakarn 10270 THAILAND
Tel. 0 2384 6060, Fax 0 2384 5701, Email : sales@flutech.co.th, www.flutech.co.th

DIMENSIONS inches (mm)

Bowl	A	B †	C	Depth	Weight lb (kg)
9-Ounce Plastic	3.5 (88)	7.1 (179)	2.2 (56)	2.9 (73)	2.0 (0.91)
9-Ounce Metal	3.5 (88)	7.4 (188)	2.2 (56)	3.1 (79)	2.0 (0.91)
Extended Metal	3.5 (88)	10.6 (269)	2.2 (56)	3.1 (79)	2.2 (1.00)

† Bowl removal clearance: add 3.1 (79) for 9-ounce bowl; 6.1 (155) for extended bowl.

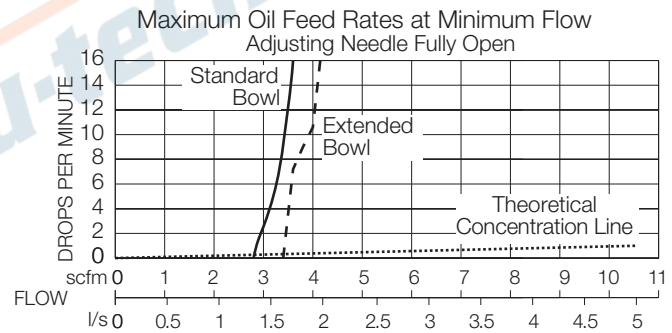
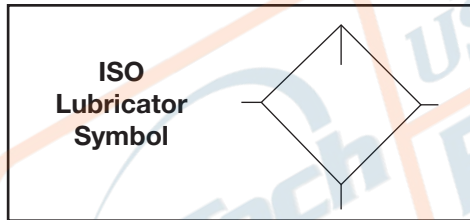
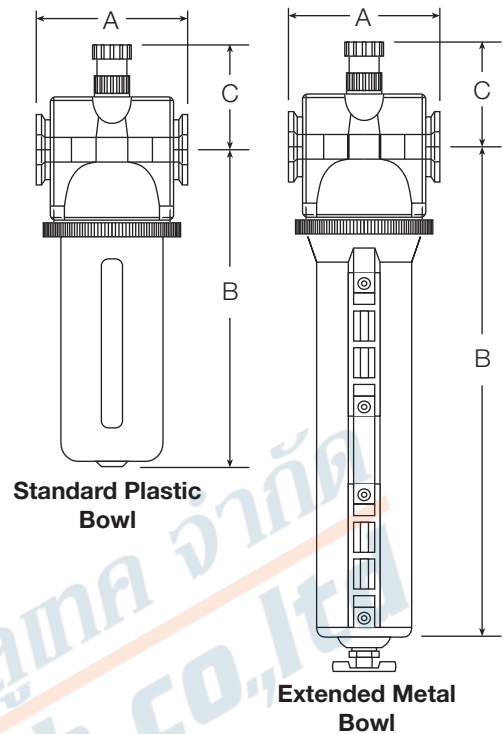

ORDERING INFORMATION

Change the letters in the sample model number below to specify the lubricator you want.

L380D - 3 Y W

BOWL TYPE

9-ounce plastic L380D
 9-ounce metal BL380D
 15-ounce metal BL380DH

PORT TYPE

3/8 NPTF 3
 1/2 NPTF 4
 3/4 NPTF 6

PORT TYPE

NPTF threads Leave blank
 BSPP threads W

OPTIONS (More than one option can be chosen. Add in alphabetical order).

None Leave blank
 Cap color
 Grey Leave blank
 Yellow C1
 Red C2
 Blue C3
 Quick-fill cap Q
 Low level switch S
 When choosing this option, the metal bowl option must be ordered.



บริษัท ฟลูเทค จำกัด
FLU-TECH CO.,LTD

845/3-4 หมู่ 3 ถ.เทพารักษ์ ต.เทพารักษ์ อ.เมือง จ.สมุทรปราการ 10270
 845/3-4 Thepharak RD., T.Thepharak, A.Muang, Samutprakarn 10270 THAILAND
 Tel. 0 2384 6060, Fax 0 2384 5701, Email : sales@flutech.co.th, www.flutech.co.th

High-Flow VANGUARD Lubricators

L29D Models Port Sizes: 3/4 to 1-1/2



Model Shown: L29D-8

- ◆ Inline mounting.
- ◆ High-strength polycarbonate plastic bowl with steel shatterguard. Optional aluminum bowl with sight glass.
- ◆ Sight-feed design.
- ◆ External adjusting knob; removable for tamper resistance.
- ◆ Optional low level switch is available on metal bowls
- ◆ **NPTF** port threads; optional **BSPB** threads.

SPECIFICATIONS

Ambient/Media Temperature:

Plastic bowl: 40° to 125°F (4° to 52°C).

Metal bowl: 40° to 175°F (4° to 79°C).

Body: Aluminum.

Bowl: 16-Ounce (480-ml) capacity polycarbonate plastic with steel shatterguard. Optional aluminum bowl with sight glass.

Bowl Ring: Aluminum.

Fluid Media: Compressed air.

Inlet Pressure:

Plastic bowl: 150 psig (10 bar) maximum.

Metal bowl: 200 psig (14 bar) maximum.

Oil Adjustment: External, tamper-resistant.

Seals: Nitrile.

Sight Dome: Nylon.

FLOW CHART

Inlet Pressure: 100 psig (7 bar)

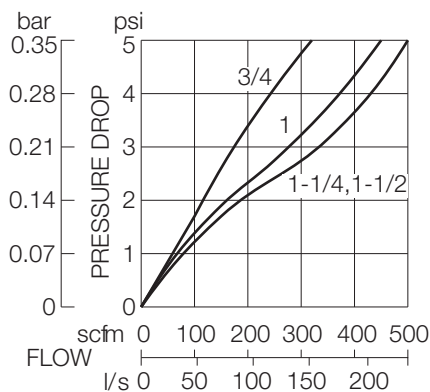

Minimum Flow: 10 scfm (4.7 l/s)



บริษัท ฟลูเทค จำกัด
FLU-TECH CO.,LTD

845/3-4 หมู่ 3 ถ.เทพารักษ์ ต.เทพารักษ์ อ.เมือง จ.สมุทรปราการ 10270

845/3-4 Thepharak RD., T.Thepharak, A.Muang, Samutprakarn 10270 THAILAND
Tel. 0 2384 6060, Fax 0 2384 5701, Email : sales@flutech.co.th, www.flutech.co.th

DIMENSIONS inches (mm)

Bowl	A	B	C	Depth	Weight
					lb (kg)
Plastic	4.3 (108)	8.2 (208)	1.4 (37)	4.2 (106)	2.63 (1.21)
Metal	4.3 (108)	7.3 (185)	1.4 (37)	4.2 (106)	2.85 (1.30)

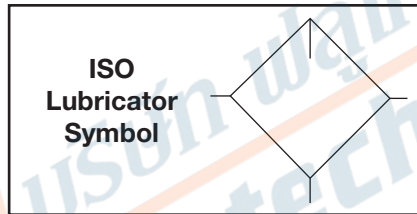
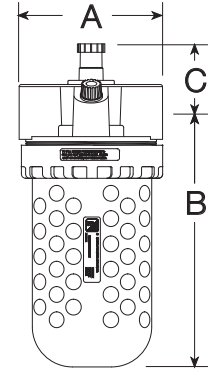

ORDERING INFORMATION

Change the letters in the sample model number below to specify the lubricator you want.

BOWL TYPE	L29D - 6	Y	W	PORT TYPE
Plastic	L29D			NPTF threads
Metal	BL29D			BSP threads
PORT SIZE				OPTIONS
3/4 NPTF	6			None
1 NPTF	8			Quick-fill Q-cap
1-1/4 NPTF	10			Low level switch;
1-1/2 NPTF	12			only available with metal bowl option.



บริษัท ฟลูเทค จำกัด
FLU-TECH CO.,LTD

845/3-4 หมู่ 3 ถ.เทพารักษ์ ต.เทพารักษ์ อ.เมือง จ.สมุทรปราการ 10270
845/3-4 Thepharak RD., T.Thepharak, A.Muang, Samutprakarn 10270 THAILAND
Tel. 0 2384 6060, Fax 0 2384 5701, Email : sales@flutech.co.th, www.flutech.co.th

High-Flow VANGUARD Lubricators

L100 Models Port Sizes: 1



Model Shown: L100-8

- ◆ Inline mounting.
- ◆ High-strength polycarbonate plastic bowl with steel shatterguard. Optional aluminum bowl with sight glass.
- ◆ Wick-feed design.
- ◆ Internal adjustment.
- ◆ NPTF port threads; optional BSPP threads.

SPECIFICATIONS

Ambient/Media Temperature:

Plastic bowl: 40° to 125°F (4° to 52°C).

Metal bowl: 40° to 175°F (4° to 79°C).

Body: Aluminum.

Bowl: 16-Ounce (480-ml) capacity polycarbonate plastic with steel shatterguard. Optional aluminum bowl with sight glass.

Bowl Ring: Aluminum.

Fluid Media: Compressed air.

Inlet Pressure:

Plastic bowl: 150 psig (10 bar) maximum.

Metal bowl: 200 psig (14 bar) maximum.

Oil Adjustment: Internal.

Seals: Nitrile.

Sight Dome: Nylon.

FLOW CHART

Inlet Pressure: 100 psig (7 bar)

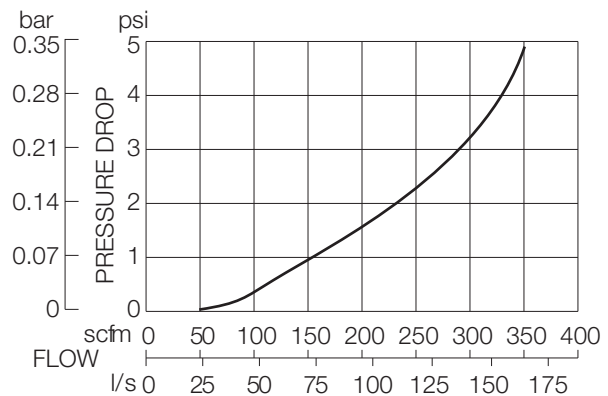

Minimum Flow: 1 port, 35 scfm (16 l/s)



บริษัท ฟลูเทค จำกัด
FLU-TECH CO.,LTD

845/3-4 หมู่ 3 ถ.เทพารักษ์ ต.เทพารักษ์ อ.เมือง จ.สมุทรปราการ 10270

845/3-4 Thepharak RD., T.Thepharak, A.Muang, Samutprakarn 10270 THAILAND
Tel. 0 2384 6060, Fax 0 2384 5701, Email : sales@flutech.co.th, www.flutech.co.th

DIMENSIONS inches (mm)

Bowl	A	B	C	Depth	Weight lb (kg)
Plastic	4.5 (114)	7.7 (195)	0.8 (21)	4.2 (106)	2.88 (1.31)
Metal	4.5 (114)	8.2 (208)	0.8 (21)	4.2 (106)	3.00 (1.36)

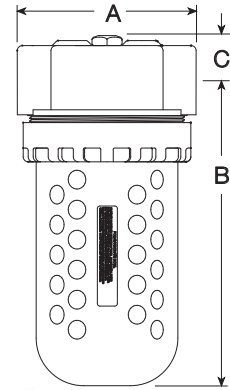

ORDERING INFORMATION

Change the letters in the sample model number below to specify the lubricator you want.

L100 - 8 Y W

<p>BOWL TYPE</p> <p>Plastic L100</p> <p>Metal BL100</p>	<p>8</p>	<p>Y</p>	<p>W</p>	<p>PORT TYPE</p> <p>NPTF threads Leave Blank</p> <p>BSPP threads W</p> <p>OPTIONS</p> <p>None Leave Blank</p> <p>Quick-fill Q-cap..... Q</p>
<p>PORT SIZE</p> <p>1 NPTF..... 8</p>				



บริษัท ฟลูเทค จำกัด
FLU-TECH CO.,LTD

845/3-4 หมู่ 3 ถ.เทพารักษ์ ต.เทพารักษ์ อ.เมือง จ.สมุทรปราการ 10270
845/3-4 Thepharak RD., T.Thepharak, A.Muang, Samutprakarn 10270 THAILAND
Tel. 0 2384 6060, Fax 0 2384 5701, Email : sales@flutech.co.th, www.flutech.co.th

High-Flow VANGUARD Lubricators

BL237D Models Port Sizes: 3/4 to 1-1/2



Model Shown: BL237D-12

- ◆ Inline mounting.
- ◆ Aluminum bowl with sight glass. Optional extended bowl.
- ◆ Sight-feed design.
- ◆ External adjusting knob; removable for tamper resistance.
- ◆ Optional low level switch is available
- ◆ NPTF port threads; optional BSPP threads.

SPECIFICATIONS

Ambient/Media Temperature:

40° to 175°F (4° to 79°C).

Body: Aluminum.

Bowl: 35-Ounce (1030-ml) capacity aluminum bowl with sight glass. Optional 62-ounce (1830-ml) extended aluminum bowl with two sight glasses.

Bowl Ring: Aluminum.

Fluid Media: Compressed air.

Inlet Pressure: 200 psig (14 bar) maximum.

Oil Adjustment: External, tamper-resistant.

Seals: Nitrile.

FLOW CHART

Inlet Pressure: 100 psig (7 bar)

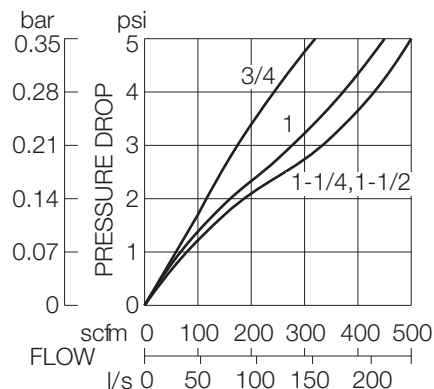

Minimum Flow: 35-Ounce bowl, 10 scfm (4.7 l/s)
62-Ounce bowl, 14 scfm (6.6 l/s)



บริษัท ฟลูเทค จำกัด
FLU-TECH CO.,LTD

845/3-4 หมู่ 3 ถ.เทพารักษ์ ต.เทพารักษ์ อ.เมือง จ.สมุทรปราการ 10270
845/3-4 Thepharak RD., T.Thepharak, A.Muang, Samutprakarn 10270 THAILAND
Tel. 0 2384 6060, Fax 0 2384 5701, Email : sales@flutech.co.th, www.flutech.co.th

DIMENSIONS inches (mm)

Port	A	B	C	Depth	Weight
					lb (kg)
3/4	4.3	10.2	2.0	4.2	2.56
1	(108)	(259)	(51)	(106)	(1.16)
1-1/4	4.3	10.6	1.6	4.2	2.56
1-1/2	(108)	(268)	(41)	(106)	(1.16)

The following have extended bowls:

3/4	4.3	15.8	2.0	4.2	3.38
1	(108)	(400)	(51)	(106)	(1.64)
1-1/4	4.3	16.1	1.6	4.2	3.38
1-1/2	(108)	(410)	(41)	(106)	(1.64)

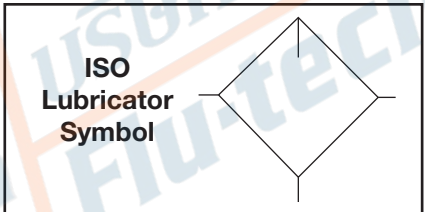
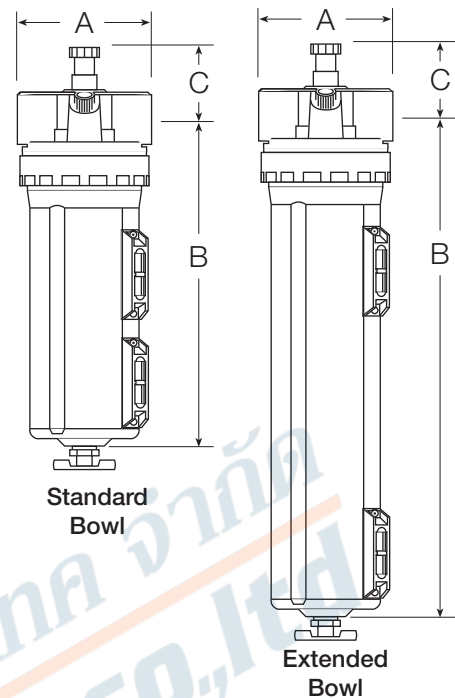

ORDERING INFORMATION

Change the letters in the sample model number below to specify the lubricator you want.

BL237D - 6 Y W

BOWL SIZE

Standard 35-ounce BL237D
 Extended 62-ounce..... BL237DH

PORT SIZE

3/4 NPTF 6
 1 NPTF 8
 1-1/4 NPTF 10
 1-1/2 NPTF 12

PORT TYPE

NPTF threads Leave Blank
 BSPP threads W

OPTIONS

None Leave Blank
 Quick-fill Q-cap..... Q
 Low level switch S



บริษัท ฟลูเทค จำกัด
FLU-TECH CO.,LTD

845/3-4 หมู่ 3 ถ.เทพารักษ์ ต.เทพารักษ์ อ.เมือง จ.สมุทรปราการ 10270
 845/3-4 Thepharak RD., T.Thepharak, A.Muang, Samutprakarn 10270 THAILAND
 Tel. 0 2384 6060, Fax 0 2384 5701, Email : sales@flutech.co.th, www.flutech.co.th