

1-1/2" AirSweep® System

Activates 4-6 feet diameter of material • Ideal for medium to large bins, hoppers, chutes, etc.

Solve tough flow problems by eliminating ratholes, bridging and material buildup.

The AirSweep® material activation system delivers on-demand product flow, eliminates hang-ups and blockages, cleans interior surfaces and enhances batch uniformity.

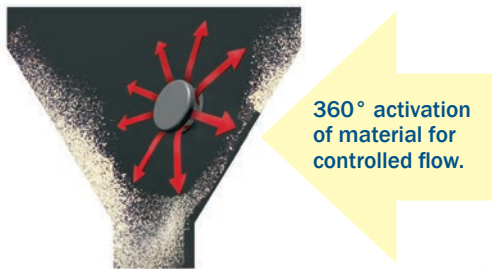

360° activation of material for controlled flow.

Each AirSweep nozzle directs a high-pressure, high-volume 360° burst of compressed air or inert gas along the inside walls of process equipment or vessels, breaking friction to lift and sweep stalled material back into the flow stream. The patented nozzle design ensures an immediate reseal after each pulse to eliminate material feedback.

Sequenced pulsing of strategically-positioned AirSweep units activate bulk material to produce a first-in, first-out controlled flow.

- System is mounted on the outside of the vessel for easy cleaning and maintenance
- Energy efficient – uses plant air
- Mount to metal, concrete, fiberglass or wood vessels
- Manufactured from high grade steel for long service life



Model VA-12 on corn hopper.

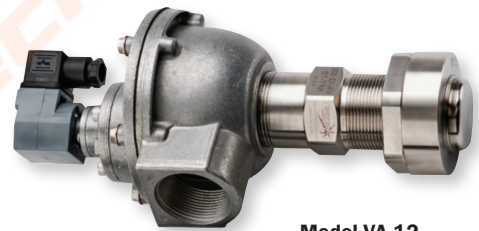

Model VA-12 (with solenoid valve, mounting coupling and lock nut)

Standard materials of construction include:

- Carbon Steel
- 304 Stainless Steel
- 316 Stainless Steel

Other materials available upon request.

For USDA-accepted AirSweep® Systems, contact a sales engineer at 1-860-928-6551

Applications:

AirSweep® Systems have successfully handled the following materials and more!

Foods		Mined		Chemicals		Other	
Animal feeds	Meal	Borax	Magnetite	Adipic acid	Iron oxide	Acetate	Pharmaceuticals
Brewers grain	Oat hulls	Coal	Phosphate	Boric acid	Lead chromate	Cements	Plastics
Chocolate	Rice bran	Copper	Shale	Calcine	Polyacrilimide	Chalk	Resins
Grains	Salts	Gypsum	Soda ash	Calcium carbonate	Sodium sulfite	Detergents	Sludge
Flour	Starch	Lead	Trona	Herbicides	Titanium dioxide	Fertilizer	Tobacco
Hops	Sugar	Limestone	Uranium	Hydrated Lime	Zinc	Fly ash	Wax flakes/pellets

Model VA-12 Specifications

Specifications subject to change without notice.

VA-12-NPT-TB

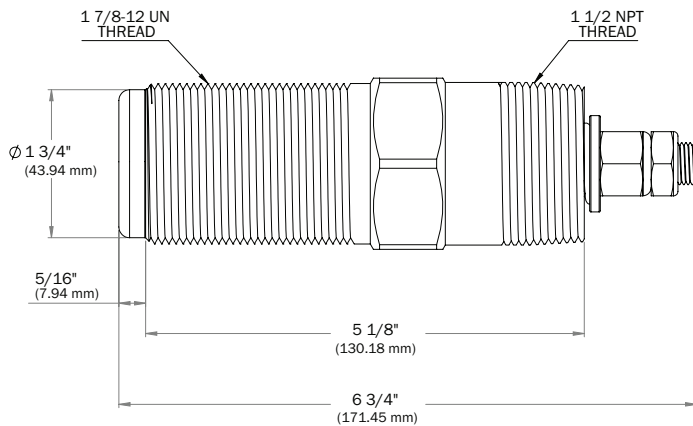

Lock Nut

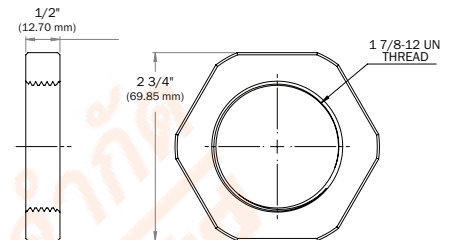

Mounting Options

Mounting Coupling (Weld to vessel)

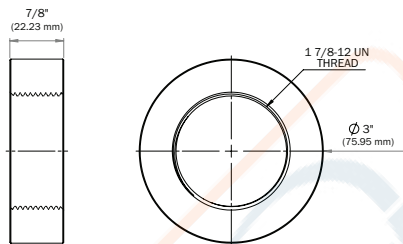

Mounting Flange (Bolt to vessel)

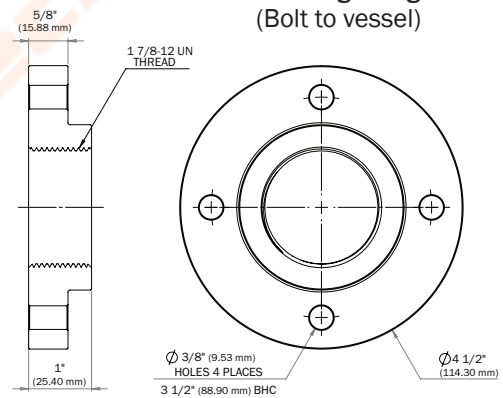

VA-12 Performance (per unit)*

Material Activation Diameter	Compressed Air/Gas Consumption (per pulse)
4 feet (1.22 m)	1.9 scf @ 80 psi (0.054 m ³ @ 5.52 bar)
6 feet (1.83 m)	2.45 scf @ 100 psi (0.069 m ³ @ 6.89 bar)

*Average in 75 lbs/ft³ material; 250 millisecond pulse

VA-12 Component Weights

	Carbon Steel	304 Stainless Steel	316 Stainless Steel
VA-12-NPT-TB	2.87 (1.30 kg)	2.89 lb (1.31 kg)	2.92 lb (1.32 kg)
LN-12	0.53 lb (0.24 kg)	0.54 lb (0.25 kg)	0.54 lb (0.24 kg)
MC-12	1.08 lb (0.49 kg)	1.09 lb (0.50 kg)	**
MF-12	2.51 lb (1.14 kg)	2.57 lb (1.17 kg)	2.58 lb (1.17 kg)

** Weight not available. Call 860-928-6551 for more information.



View AirSweep videos:

www.controlconceptsusa.com/videos/

Patented design ensures an immediate, dust-tight reseal after each pulse of air or compressed gas, preventing clogging and material buildup.

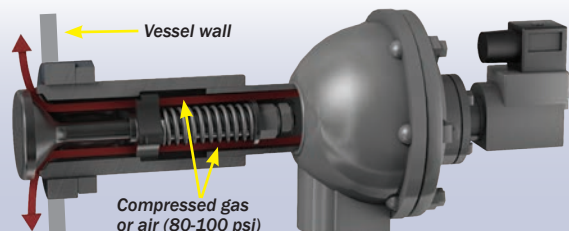

Typical VA-12 AirSweep System

A typical AirSweep® material activation system consists of strategically-located AirSweeps, high-flow solenoid valves, electronic sequence controller and air receiver.

The average AirSweep® System uses less than 10 cfm of compressed air or gas making it energy and cost efficient. No damage, vibration, stress or wear to container walls.

Contact us for information and a detailed AirSweep® proposal, engineered specifically for your application. Call 860-928-6551, or email us at Sales@ControlConceptsUSA.com

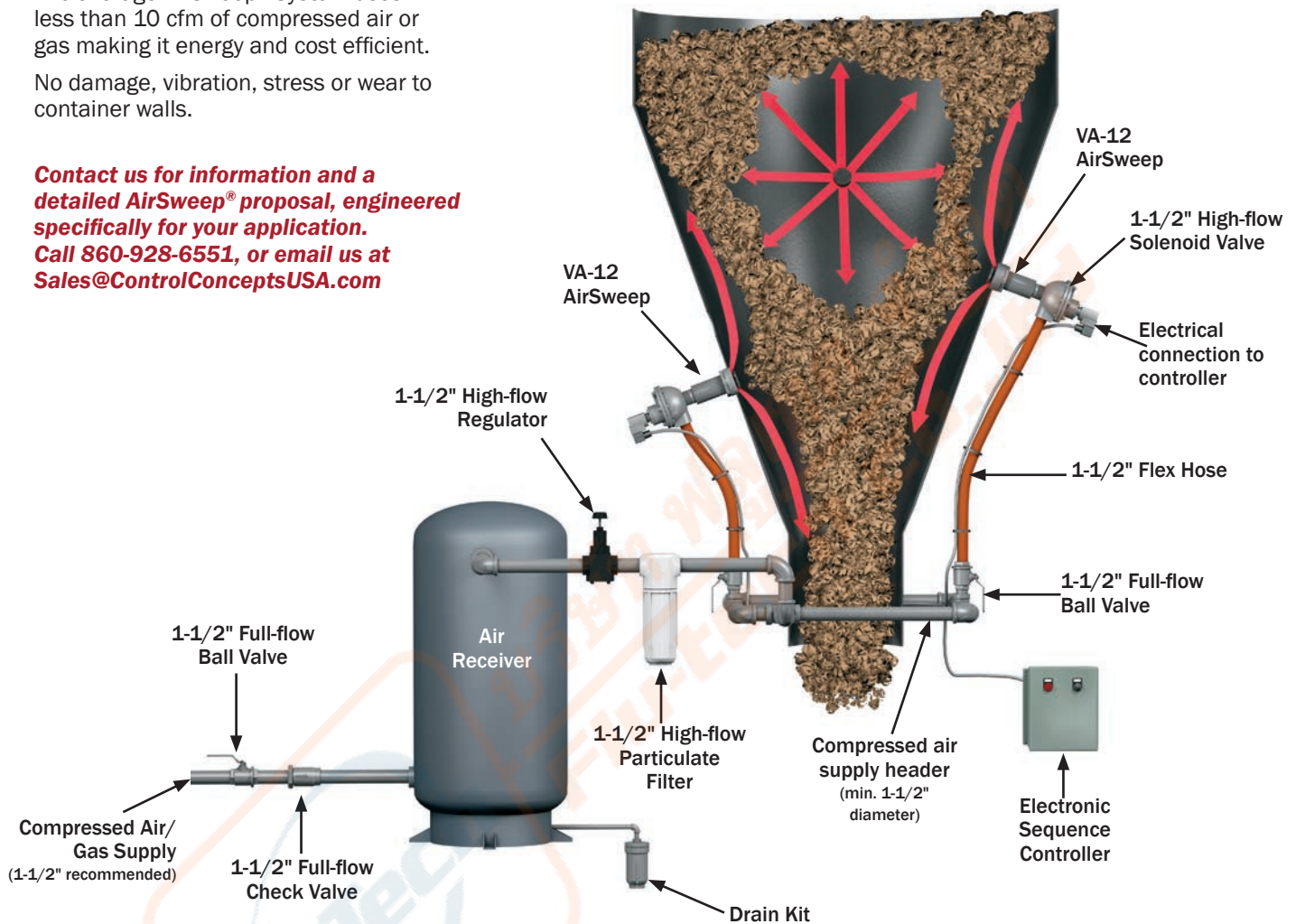

Typical AirSweep® System Components

AirSweep – Model VA-12

Solenoid Valve – Delivers rapid, high-volume pulse of compressed air/gas to AirSweep nozzle.

Flex Hose Assembly – Connects the solenoid valve to hard-piped header loop.

1-1/2" Full-flow Ball Valve – Isolation valve for individual nozzles.

1-1/2" High-flow Particulate Filter – Point-of-use particulate filtration enhances life of system components by removal of in-line contaminants.

60-gallon Air Receiver – Compressed air reservoir ensures instantaneous volume for system.

1-1/2" High-flow Regulator – Regulates compressed air supply to within 80-100 psi for proper AirSweep operation.

1-1/2" Full-flow Check Valve – Ensures one-way flow to system.

1-1/2" Full-flow Ball Valve – System shut-off.

Electronic Sequence Controller – Controls sequenced pulsing of AirSweep system; adjustable for any process.



บริษัท ฟลูเทค จำกัด
Flu-tech co.,ltd
Authorized Distributor

845/3-4 หมู่ 3 ถ.เทพารักษ์ ต.เทพารักษ์ อ.เมือง จ.สมุทรปราการ 10270

845/3-4 Thepharak RD., T.Thepharak, A.Muang Samutprakarn 10270 (THAILAND)
Tel. 0 2384 6060, Fax. 0 2384 5701, Email : Sales@flutech.co.th, www.flutech.co.th

Model VA-12 Mounting Options

MC-12 Mounting Coupling Installation (Weld to vessel)

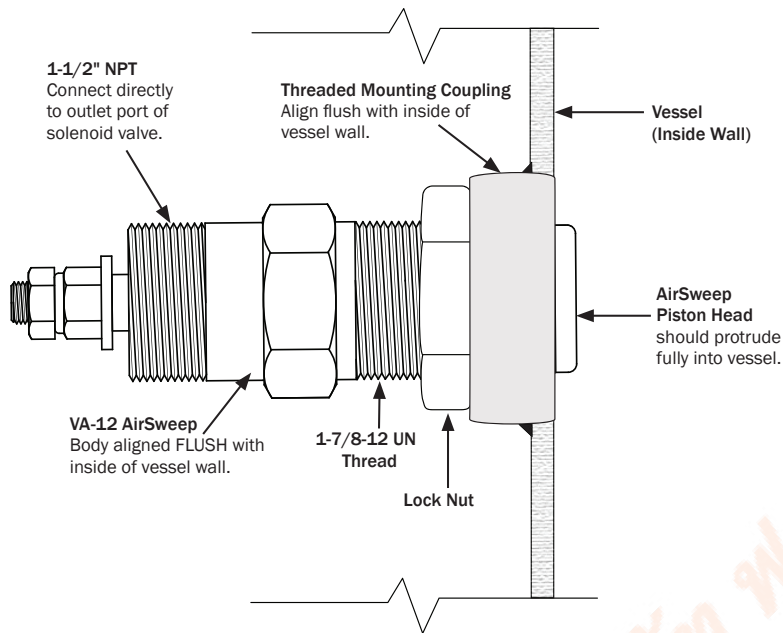

MC-12 Mounting Coupling Installation

1. Cut hole in vessel wall. Recommended hole size is approximately 1/8" (3.175 mm) greater than diameter of coupling to allow coupling to pass through curved wall. The MC-12 mounting coupling is 3" (76.2 mm) dia., therefore the recommended hole size is 3-1/8" (79.375 mm).
2. Align coupling flush with inside of vessel wall and weld continuous bead to exterior of wall.
3. Apply anti-seize compound to front threaded section of AirSweep. Thread AirSweep into position so the front of the body is aligned with the front of the coupling. This will properly position the piston head within the vessel.
4. After the AirSweep is correctly positioned, tighten lock nut against coupling to keep AirSweep in position.

Note: On sharply curved vessel walls, the body of AirSweep will extend slightly into the bin at the top and bottom (12:00 & 6:00 positions), and should be flush at sides (3:00 & 9:00 positions).

MF-12 Mounting Flange Installation (Bolt to vessel)

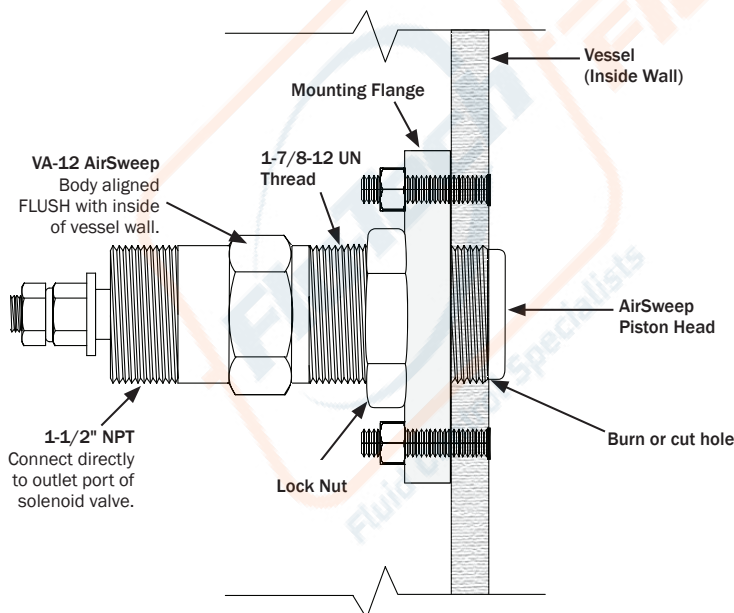

MF-12 Mounting Flange Installation

1. Position flange on wall surface. Mark hole for AirSweep. Mark bolt circle layout.
2. Drill or cut hole for AirSweep and bolt holes. The hole size should be sufficient diameter to allow AirSweep to pass through wall.
3. Fasten flange to wall by bolting
4. Apply anti-seize compound to front threaded section of AirSweep. Thread the AirSweep into position so that the front of the AirSweep body is aligned with the inside wall of vessel. This will properly position piston head within the vessel.
5. After the AirSweep is correctly positioned, tighten lock nut against flange to keep AirSweep in position.

Model VA-12 Assembly and Mounting

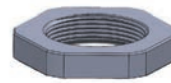
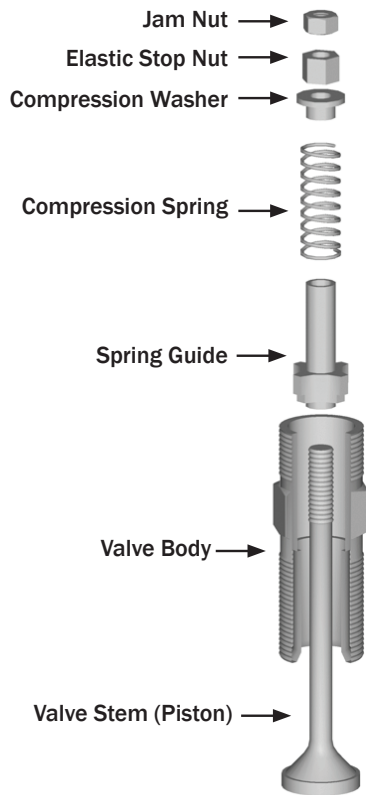

Lock Nut

Mounting Options

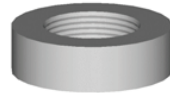

Mounting Coupling
(Weld to vessel)

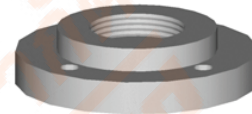

Mounting Flange
(Bolt to vessel)

Part Number per Material of Construction

Qty.	Description	Carbon Steel	304 Stainless Steel	316 Stainless Steel
1	Valve Body	VB-12-CS	VB-12-SS	VB-12-316
*1	Valve Stem	VCW-12-CS	VCW-12-SS	VCW-12-316
*1	Spring Guide	SG-12-CS	SG-12-SS	SG-12-316
*1	Compression Spring	CS-1251-316	CS-1251-316	CS-1251-316
*1	Compression Washer	CW-1251-316	CW-1251-316	CW-1251-316
*1	Elastic Stop Nut	ESN-1251-CS	ESN-1251-SS	ESN-1251-SS
*1	Jam Nut	JN-1251-CS	JN-1251-SS	JN-1251-SS
1	Mounting Flange	MF-12-CS-T	MF-12-SS-T	MF-12-316-T
1	Mounting Coupling	MC-12-CS	MC-12-SS	MC-12-316
1	Lock Nut	LN-12-CS	LN-12-SS	LN-12-316

* This part is included in the Rebuild Kit.

Model VA-12 Rebuild Kit

AirSweep Nozzle Rebuild Kit contains 1 each:

- valve stem
- spring guide
- compression washer
- compression spring
- elastic stop nut
- jam nut

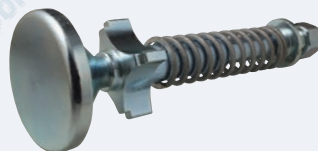

When ordering, specify material of construction.

		Model VA-12 Rebuild Kit
Construction Material	Carbon Steel	RK-12-CS
	304 Stainless Steel	RK-12-SS
	316 Stainless Steel	RK-12-316

Recommended service interval of internal parts:

Approximately 1 million cycles.*

Maintenance recommended:

Replacement of internal parts.

* Typical service interval under standard operating conditions. Some environments, materials and processes may result in a shorter useful service interval.

Typical Operating Parameters – Compressed Air Consumption for Model VA-12 AirSweep

Recommended operating pressure	80 to 100 psi
Typical effective diameter of material activation <i>(dry, powdered material, 60-75 lbs/ft³)</i>	4 to 6 feet (1.22 to 1.83 m) around each nozzle
Recommended pulse time	250 milliseconds
Approximate air/gas consumption rate per 250 millisecond pulse	1.9 ft ³ @ 80 psi 2.45 ft ³ @ 100 psi
Typical sequence rate range <i>(application/material dependent)</i>	3 pulses to 12 pulses per minute
Typical (approx.) compressed air/gas consumption rate range <i>(based on typical sequence rate range of 3 to 12 pulses/min)</i>	5.7 to 22.8 scfm @ 80 psi 7.35 to 29.4 scfm @ 100 psi

VA-12 Compressed Air/Gas Consumption

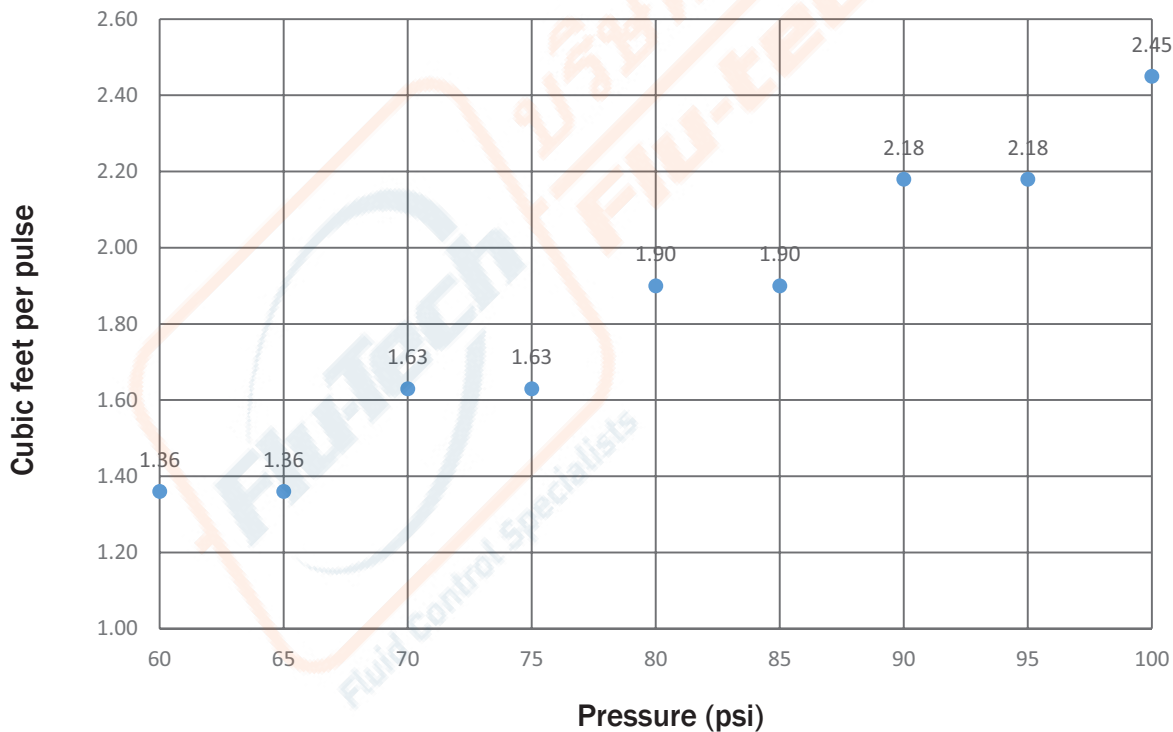

● = Consumption per 250 millisecond pulse