

Type 0400

2/2-way solenoid valve
2/2-Wege-Magnetventil
Électrovanne 2/2 voies

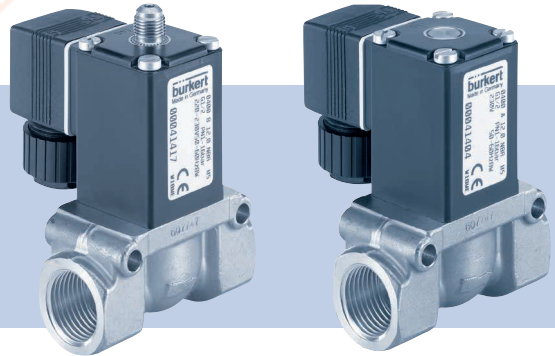

Operating Instructions

Bedienungsanleitung
Manuel d'utilisation

Contents

1	Operating instructions	2
2	Intended use.....	3
3	Basic safety instructions.....	3
4	Technical data.....	5
5	Installation.....	7
6	Maintenance, Troubleshooting.....	9
7	Spare parts.....	10
8	Transport, Storage, Disposal.....	11

1 OPERATING INSTRUCTIONS

The operating instructions contain important information.

- ▶ Read the operating instructions carefully and follow the safety instructions in particular, and also observe the operating conditions.
- ▶ Operating instructions must be available to each user.
- ▶ The liability and warranty for the device are void if the operating instructions are not followed.

1.1 Symbols

- ▶ designates an instruction to prevent risks.
- designates a procedure which you must carry out.

Warning of injuries:

 **DANGER!** Imminent danger! Serious or fatal injuries.

 **WARNING!** Potential danger! Serious or fatal injuries.

 **CAUTION!** Danger! Minor or moderately severe injuries.

Warns of damage to property:

2 INTENDED USE

Incorrect use of the solenoid valve Type 0400 can be dangerous to people, nearby equipment and the environment.

- ▶ The device is designed to control, shut off and meter media.
- ▶ Provided the cable plug is connected and installed correctly, the device satisfies protection class IP65 in accordance with DIN EN 60529 / IEC 60529.
- ▶ Use according to the permitted data, operating conditions and conditions of use specified in the contract documents and operating instructions.
- ▶ Correct transportation, correct storage and installation and careful use and maintenance are essential for reliable and problem-free operation.
- ▶ Use the device only as intended.

2.1 Restrictions

If exporting the device, observe any existing restrictions.

2.2 Definition of term

In these operating instructions, the term “device” always refers to the solenoid valve Type 0400.

3 BASIC SAFETY INSTRUCTIONS

These safety instructions do not make allowance for any contingencies and events which may arise during installation, operation and maintenance.



Danger – high pressure.

- ▶ Before loosening the lines and valves, turn off the pressure and vent the lines.

Risk of electric shock.

- ▶ Before reaching into the system, switch off the power supply and secure to prevent reactivation!
- ▶ Observe applicable accident prevention and safety regulations for electrical equipment!

Risk of burns or risk of fire if used continuously through hot device surface.

- ▶ Keep the device away from highly flammable substances and media and do not touch with bare hands.

Risk of injury due to malfunction of valves with alternating current (AC).

Sticking core causes coil to overheat, resulting in a malfunction.

- ▶ Monitor process to ensure function is in perfect working order.

Risk of short-circuit or escape of media through leaking screw joints.

- ▶ Ensure seals are seated correctly.
- ▶ Carefully screw valve and connection lines together.



General hazardous situations.

To prevent injury, ensure that:

- ▶ Do not make any internal or external changes. Ensure that the system cannot be activated unintentionally.
- ▶ Installation and repair work may be carried out by authorized technicians only and with the appropriate tools.
- ▶ After an interruption in the power supply or pneumatic supply, ensure that the process is restarted in a defined or controlled manner.

- ▶ Do not put any loads on the body.
- ▶ The general rules of technology apply to application planning and operation of the device.

3.1 Warranty

The warranty is only valid if the device is used as intended in accordance with the specified application conditions.

3.2 Information on the internet

The operating instructions for type 0400 can be found on the internet at:

www.flutech.co.th → Type 0400

4 TECHNICAL DATA

4.1 Operating conditions



The following values are indicated on the type label:

- Voltage (Tolerance $\pm 10\%$) / Current type
- Coil power consumption (active power in W - at operating temp.)
- Pressure range
- Body material: Aluminium (AL) anodized DN6, Brass (MS) DN12
- Seal material: NBR, FKM

Circuit function

A (NC)		2/2 way valve, normally closed
B (NO)		2/2 way valve, normally open

Protection class

IP65 in accordance with DIN EN 60529 / IEC 60529 with cable plug, e.g. Bürkert Type 2508

Special instructions for valves circuit function B (NO) with deaeration connection G1/8 on the coil:

The deenergized valve is open. The medium also flows off via the deaeration connection on the coil.

Valves of this design are therefore suitable for relieving compressors only.

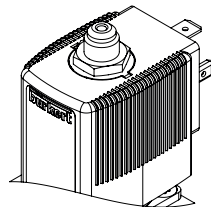

4.2 Application conditions

Ambient temperature

max. +55 °C

Medium temperature

NBR: -10...+90 °C

FKM: -10...+100 °C

Operating duration

Unless otherwise indicated on the type label, the solenoid system is suitable for continuous operation



Important information for functional reliability during continuous operation: If standstill for a long period at least 1-2 activations per day are recommended.

Service life High switching frequency and high pressures reduce the service life

Permitted medium temperature depending on seal material

Seal material	Medium temperature
NBR	-10...+90 °C
FKM	-10...+100 °C

Permitted media depending on seal material

Seal material	Permitted media
NBR	Neutral media such as compressed air, illuminating gas, water, hydraulic oil, oils and grease without additives
FKM	Oxygen, hot air, hot oils, oils with additives, Per solutions

4.3 Conformity

In accordance with the EC Declaration of conformity, the solenoid valve Type 0400 is compliant with the EC Directives (if applicable).

4.4 Standards

The applied standards, which verify conformity with the EC Directives, can be found on the EC-Type Examination Certificate and / or the EC Declaration of Conformity (if applicable).

4.5 Type label (Example)

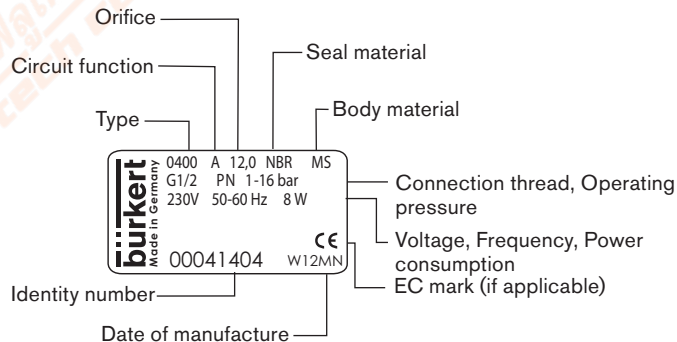

5 INSTALLATION

5.1 Safety instructions



DANGER!

Risk of injury from high pressure in the equipment.

- ▶ Before loosening the pipes and valves, turn off the pressure and vent the lines.

Risk of injury due to electrical shock.

- ▶ Before reaching into the device or the equipment, switch off the power supply and secure to prevent reactivation.
- ▶ Observe applicable accident prevention and safety regulations for electrical equipment.



WARNING!

Risk of injury from improper installation.

- ▶ Installation may be carried out by authorized technicians only and with the appropriate tools.
- ▶ Secure system from unintentional activation.
- ▶ Following assembly, ensure a controlled restart.

5.2 Before installation

Installation position: any, coil preferably upwards.

- Check pipelines for dirt and clean.
- Install a dirt filter before the valve inlet ($\leq 500 \mu\text{m}$).

NOTE!

Caution risk of breakage!

- Do not use the coil as a lever arm.

- Seal thread.
- Hold the device with a open-end wrench on the valve body and screw into the pipeline.



Valve body must not be installed under tension.
Sealing material must not get into the device.

- Observe direction of flow:
The arrow on the body indicates the direction of flow.

5.3 Electrical connection of the cable plug



WARNING!

Risk of injury due to electrical shock.

- ▶ Before reaching into the system, switch off the power supply and secure to prevent reactivation.
- ▶ Observe applicable accident prevention and safety regulations for electrical equipment.

If the protective conductor is not connected, there is a risk of electric shock.

- ▶ Always connect protective conductor.
- ▶ Check electrical continuity between coil and body.

- Shut off the power.
- Tighten cable plug, observing max. torque 1 Nm.
- Check that seal is fitted correctly.
- Connect protective conductor and check electrical continuity between coil and body.

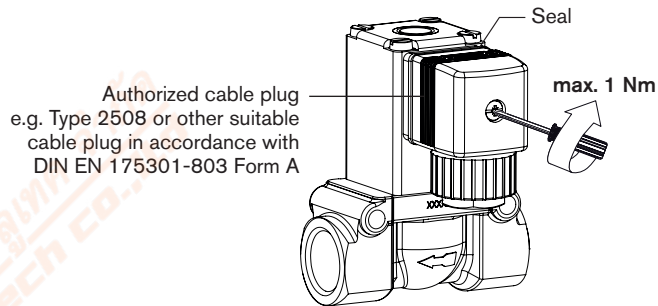

Cable plug can be rotated 4 x 90°.

5.4 Electrical connection of the coil

Coil can be rotated 90° or 180°.

- Shut off the power.
- Disassemble the cable plug.
- Loosen 4 screws.
- Turn coil.

6 MAINTENANCE, TROUBLESHOOTING



WARNING!

Risk of injury from improper maintenance.

- ▶ Maintenance may be carried out by authorized technicians only and with the appropriate tools!

Risk of injury from unintentional activation of the system and an uncontrolled restart.

- ▶ Secure system from unintentional activation.
- ▶ Following maintenance, ensure a controlled restart.

6.1 Malfunctions

If malfunctions occur, check whether:

- the device has been installed according to the instructions,
- the electrical and fluid connections are correct,
- the device is not damaged,
- all screws have been tightened,
- the voltage and pressure have been switched on,
- the pipelines are clean,
- the power supply is adequately high.

Possible cause if the valve does not switch:

- Short circuit or coil interrupted.
- Inadequate power supply.
- Core or core area dirty.
- Medium pressure outside the permitted pressure range.

Possible cause if the valve does not close:

- Internal space of the valve is dirty.

If the valve still does not switch, please contact your Bürkert Service representative.

7 SPARE PARTS



CAUTION!

Risk of injury and/or damage by the use of incorrect parts.

Incorrect accessories and unsuitable spare parts may cause injuries and damage the device and the surrounding area.

► Use only original accessories and original spare parts from Bürkert.

7.1 Ordering spare parts

Order the spare parts sets quoting the positions (Pos. 1: Coil set, Pos. 2: Wearing parts set) and the identity number of the device.

7.2 Overview of spare parts

