



PRODUCT INFORMATION

INTEGRATED FILTER/REGULATORS

AIR PREPARATION



ROSS CONTROLS

INTEGRATED FILTER/REGULATORS – KEY FEATURES

- Filter and Pressure Regulator combined into a single module to provide the compactness needed where space is limited
- All sizes have essentially the same operating characteristics as their corresponding individual filters and regulators
- All Filter/Regulator include internal automatic filter drain or manual drain options
- Pressure gauge included
- Regulator function is self relieving, and includes front and rear gauge ports
- 5-, 20-, 40-micron filter elements available (see table below)
- Metal or high strength polycarbonate bowl
- Modular or in-line mounting
- MD3™ and MD4™ series can be modularly connected to a L-O-X® Lockout Valve
- Stainless steel Filter/Regulator and L-O-X® Lockout Valve combination available

INTEGRATED FILTER/REGULATOR TYPE/SERIES	AVAILABLE PORT SIZES					FLOW	FILTRATION			BOWLS & DRAINS OPTIONS				REGULATOR TYPE		OPTIONS		Page
	1/8	1/4	3/8	1/2	3/4	MAX FLOW (scfm)	5 μ	20 μ	40 μ	POLYCARBONATE BOWL	METAL BOWL	AUTOMATIC DRAIN	MANUAL DRAIN	PISTON	DIAPHRAGM	SELF RELIEVING	NON RELIEVING	
BANTAM						24												G3.3
MINIATURE						24												G3.4
MID-SIZE						105												G3.5
MD3™						110												G3.6
FULL-SIZE						180												G3.7
MD4™						230												G3.8
STAINLESS STEEL with L-O-X® LOCKOUT VALVE																		
																		G3.9

Modular Integrated Filter/Regulators

BANTAM Series

Port Sizes: 1/8 & 1/4 – Flow to 24 scfm

Port Size	Automatic Drain		Manual Drain	
	Polycarbonate Bowl	Metal Bowl	Polycarbonate Bowl	Metal Bowl
	Model Number	Model Number	Model Number	Model Number
With THREADED PORTS - Piston Type Regulator:				
1/8 NPTF	5D01C0110	5D01C0210	5D01C0310	5D01C0410
1/8 G	C5D01C0110	C5D01C0210	C5D01C0310	C5D01C0410
1/4 NPTF	5D02C0110	5D02C0210	5D02C0310	5D02C0410
1/4 G	C5D02C0110	C5D02C0210	C5D02C0310	C5D02C0410
With Quick-Connect TUBE FITTINGS - Piston Type Regulator:				
1/4	5D03C0110	5D03C0210	5D03C0310	5D03C0410
3/8	5D04C0110	5D04C0210	5D04C0310	5D04C0410
4mm	5D05C0110	5D05C0210	5D05C0310	5D05C0410
6mm	5D06C0110	5D06C0210	5D06C0310	5D06C0410
8mm	5D07C0110	5D07C0210	5D07C0310	5D07C0410
10mm	5D08C0110	5D08C0210	5D08C0310	5D08C0410
With Quick-Connect TUBE FITTINGS - Diaphragm Type Regulator:				
1/4	5D03C0120	5D03C0220	5D03C0320	5D03C0410
3/8	5D04C0120	5D04C0220	5D04C0320	5D04C0420
4mm	5D05C0120	5D05C0220	5D05C0320	5D05C0420
6mm	5D06C0120	5D06C0220	5D06C0320	5D06C0420
8mm	5D07C0120	5D07C0220	5D07C0320	5D07C0420
10mm	5D08C0120	5D08C0220	5D08C0320	5D08C0420

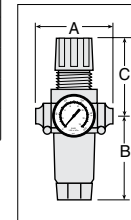
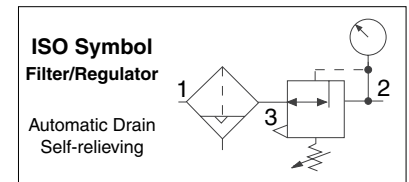

Port Size	Bowl Capacity	Dimensions inches (mm)				Weight † lb (kg)
		A	B**	C	Depth †	
No Port	2-oz (60-ml)	1.7 (43)	3.6 (92)	2.6 (67)	1.8 (45)	0.31 (0.15)
1/8, 1/4 (NPTF or G)	2-oz (60-ml)	3.0 (76)	3.6 (92)	2.6 (67)	1.8 (45)	0.53 (0.24)
Models below have quick-connect tube fittings.						
1/4, 4, 6 mm	2-oz (60-ml)	3.4 (86)	3.6 (92)	2.6 (67)	1.8 (45)	0.51 (0.23)
3/8, 10 mm	2-oz (60-ml)	3.9 (99)	3.6 (92)	2.6 (67)	1.8 (45)	0.51 (0.23)
8 mm	2-oz (60-ml)	3.1 (79)	3.6 (92)	2.6 (67)	1.8 (45)	0.51 (0.23)

** Dimension for polycarbonate filter bowl; metal bowl is 3.8 (97). † Less gauge.

REPLACEMENT FILTER ELEMENTS		
Element Rating	Element Material	Model Number
5-µm - Standard	Polyethylene	933K77
5-µm - Optional	Sintered Bronze	R-KA130-27E5
20-µm - Optional	Sintered Bronze	R-KA130-27E4
40-µm - Optional	Sintered Bronze	R-KA130-27E3

G3

G

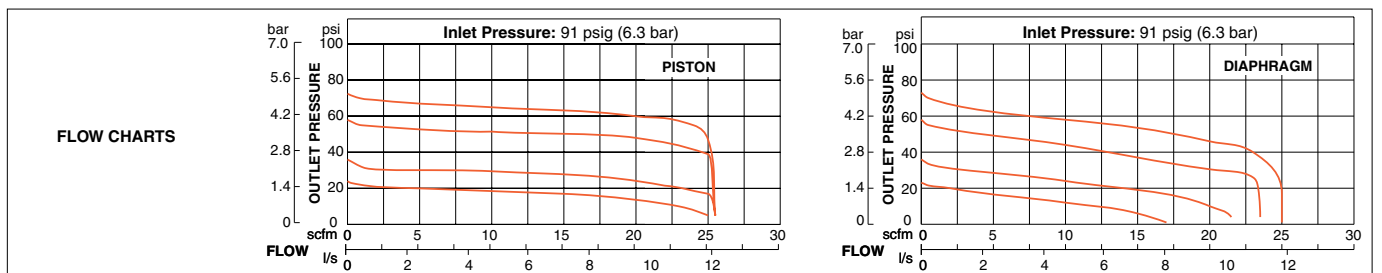

Pressure Gauge included. Accessories ordered separately, refer to page G6.3-4.

STANDARD SPECIFICATIONS (for units on this page):

Construction Design	Filter – Fiber Regulator – Piston	Outlet Pressure	Adjustable up to 100 psig (7 bar).
Temperature	Ambient/Media: Polycarbonate Bowl: 40° to 125°F (4° to 52°C) Metal Bowl: 40° to 150°F (4° to 66°C)	Pressure Gauge	0 to 160 psig (0 to 11 bar); 1/8 NPT gauge ports front and rear
Fluid Media	Compressed air	Panel Mounting	1-3/16 inch (30 mm) hole required
Operating Pressure	Automatic Drain Models Polycarbonate Bowl: Up to 150 psig (up to 10 bar) Metal Bowl: Up to 200 psig (up to 14 bar)	Construction Material	Filter Element: 5-micron rated polyethylene
	Manual Drain Models Polycarbonate Bowl: 0 to 150 psig (0 to 10 bar) Metal Bowl: 0 to 200 psig (0 to 14 bar)		Body: Acetal Bowl: Polycarbonate or Aluminum Seals: Nitrile

In-line Integrated Filter/Regulators

MINIATURE Series

Port Sizes: 1/8 & 1/4 – Flow to 24 scfm

Port Size	Port Threads	Automatic Drain		Manual Drain	
		Polycarbonate Bowl	Metal Bowl	Polycarbonate Bowl	Metal Bowl
		Model Number	Model Number	Model Number	Model Number
with Piston Type Regulator					
1/8	NPTF	5321C1032	5322C1031	5321C1002	5322C1001
	G	C5321C1032	C5322C1031	C5321C1002	C5322C1001
1/4	NPTF	5321C2032	5322C2031	5321C2002	5322C2001
	G	C5321C2032	C5322C2031	C5321C2002	C5322C2001
with Diaphragm Type Regulator					
1/8	NPTF	5321C1042	5322C1041	5321C1022	5322C1021
	G	C5321C1042	C5322C1041	C5321C1022	C5322C1021
1/4	NPTF	5321C2042	5322C2041	5321C2022	5322C2021
	G	C5321C2042	C5322C2041	C5321C2022	C5322C2021



G3

Port Size	Bowl Type	Bowl Capacity	Dimensions inches (mm)				Weight † lb (kg)
			A	B	C	Depth †	
1/8, 1/4	Polycarbonate	2-oz (60-ml)	1.6 (41)	3.6 (92)	2.6 (65)	1.6 (41)	0.53 (0.24)
	Aluminum	2-oz (60-ml)	1.6 (41)	4.3 (109)	2.6 (65)	1.6 (41)	0.53 (0.24)

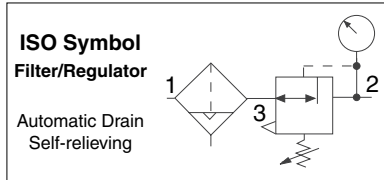
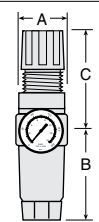

† Less gauge.

REPLACEMENT FILTER ELEMENTS

Element Rating	Element Material	Model Number
5-µm - Standard	Polyethylene	933K77
5-µm - Optional	Sintered Bronze	R-KA130-27E5
20-µm - Optional	Sintered Bronze	R-KA130-27E4
40-µm - Optional	Sintered Bronze	R-KA130-27E3

FLOW CHARTS

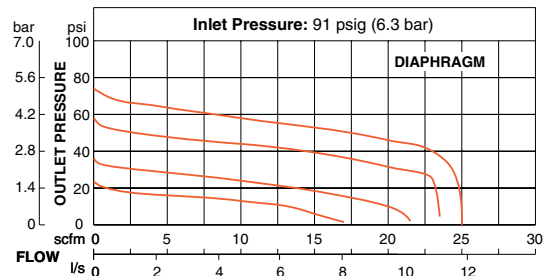
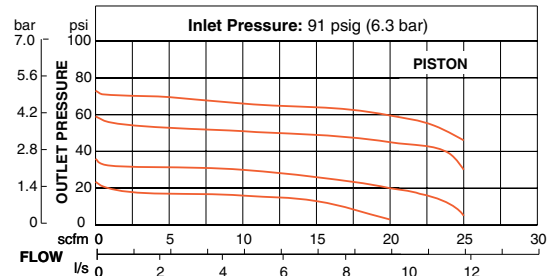

G

Pressure Gauge included.
Accessories ordered separately, refer to page G6.3-4.

STANDARD SPECIFICATIONS (for units on this page):

Construction Design	Filter – Fiber Regulator – Piston	Outlet Pressure	Adjustable up to 100 psig (7 bar).
Temperature	Ambient/Media: Polycarbonate Bowl: 40° to 125°F (4° to 52°C) Metal Bowl: 40° to 150°F (4° to 66°C)	Pressure Gauge	0 to 160 psig (0 to 11 bar); 1/8 NPT gauge ports front and rear
Fluid Media	Compressed air	Panel Mounting	1-3/16 inch (30 mm) hole required
Operating Pressure	Automatic Drain Models Polycarbonate Bowl: Up to 150 psig (up to 10 bar) Metal Bowl: Up to 200 psig (up to 14 bar)	Filter Drain	Internal automatic drain or manual drain
	Manual Drain Models Polycarbonate Bowl: 0 to 150 psig (0 to 10 bar) Metal Bowl: 0 to 200 psig (0 to 14 bar)	Construction Material	Filter Element: 5-micron rated polyethylene
			Body: Aluminum
	Dome: Acetal		
		Knob: Acetal	
		Seals: Nitrile	

Modular Integrated Filter/Regulators

MID-SIZE Series

Port Sizes: 1/4, 3/8 & 1/2 – Flow to 105 scfm



Port Size	Port Threads	Automatic Drain		Manual Drain	
		Polycarbonate Bowl	Metal Bowl	Polycarbonate Bowl	Metal Bowl
		Model Number	Model Number	Model Number	Model Number
1/4	NPTF	5321B2052	5322B2051	5321B2062	5322B2061
	G	C5321B2052	C5322B2051	C5321B2062	C5322B2061
3/8	NPTF	5321B3052	5322B3051	5321B3062	5322B3061
	G	C5321B3052	C5322B3051	C5321B3062	C5322B3061
1/2	NPTF	5321B4052	5322B4051	5321B4062	5322B4061
	G	C5321B4052	C5322B4051	C5321B4062	C5322B4061

Port Size	Bowl Type	Bowl Capacity	Dimensions inches (mm)				Weight † lb (kg)
			A	B**	C***	Depth †	
1/4, 3/8, 1/2	Polycarbonate	4-oz (120-ml)	2.7 (67)	4.6 (116)	3.3 (83)	2.4 (60)	1.44 (0.65)
	Zinc	4-oz (120-ml)	2.7 (67)	4.9 (123)	3.3 (83)	2.4 (60)	1.50 (0.68)

** Bowl removal clearance: add 3.1 (79). *** Dome removal clearance: add 0.63 (16).
† Less gauge.

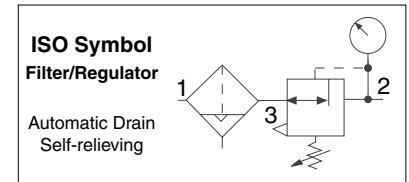

G3

REPLACEMENT FILTER ELEMENTS

Element Rating	Element Material	Model Number
5-µm - Standard	Polyethylene	936K77
5-µm - Optional	Sintered Bronze	R-KA60F-03E5
20-µm - Optional	Sintered Bronze	R-KA60F-03E4
40-µm - Optional	Sintered Bronze	R-KA60F-03E3

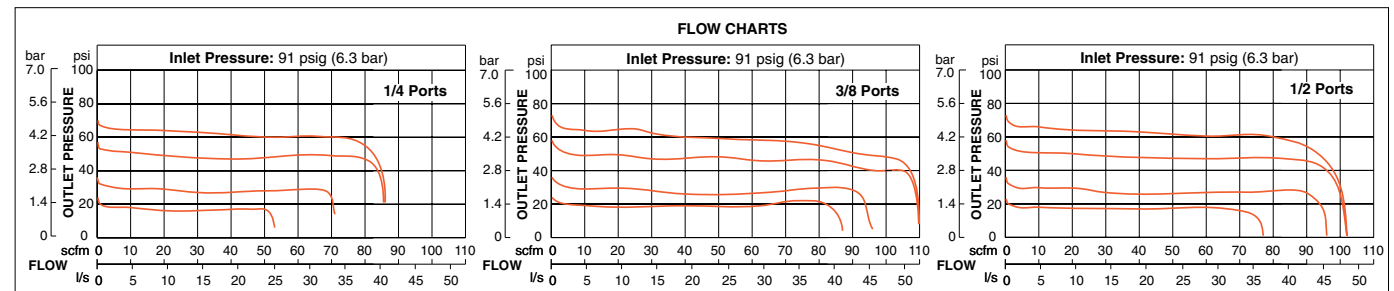
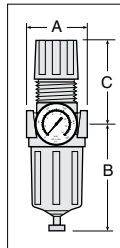

Pressure Gauge included.
Accessories ordered separately, refer to page G6.3-4.

G

STANDARD SPECIFICATIONS (for units on this page):

Construction Design	Filter – Fiber Regulator – Piston	Outlet Pressure	Adjustable up to 100 psig (7 bar).
Temperature	Ambient/Media: Polycarbonate Bowl: 40° to 125°F (4° to 52°C) Metal Bowl: 40° to 175°F (4° to 80°C)	Pressure Gauge	0 to 200 psig (0 to 14 bar); 1/4 NPT gauge ports front and rear
Fluid Media	Compressed air	Panel Mounting	1-9/16 inch (40 mm) hole required
Operating Pressure	Automatic Drain Models Polycarbonate Bowl: Up to 150 psig (up to 10 bar) Metal Bowl: Up to 200 psig (up to 14 bar)	Filter Drain	Internal automatic drain or manual drain
	Manual Drain Models Polycarbonate Bowl: 0 to 150 psig (0 to 10 bar) Metal Bowl: 0 to 200 psig (0 to 14 bar)	Construction Material	Filter Element: 5-micron rated polyethylene Body: Zinc Bowl: Polycarbonate with zinc shatterguard, or zinc bowl. Dome: Acetal Knob: Acetal Seals: Nitrile

Port Sizes: 1/4, 3/8 & 1/2 – Flow to 110 scfm

Choose your options (in red) to configure your model number.

MD3 **53P** **B** **M** **C** **2** **A** **A** **1**

BOWL MATERIAL/SIZE	
Polycarbonate Bowl 5.1-oz (151-ml)	53P
Metal Bowl 6-oz (177-ml)	53M

FILTER ELEMENT TYPE	
40-µm Sintered Bronze	A
5-µm Polyethylene	B
5-µm Sintered Bronze	E
20-µm Sintered Bronze	F

BOWL DRAIN	
Manual Drain	M
Float Drain	F
Less Drain Fitting (1/4 NPT female instead)	L

PIPE SIZE	
1/4 NPTF	2
3/8 NPTF	3
1/2 NPTF	4
1/4 G	B
3/8 G	C
1/2 G	D

ADJUSTMENT RANGE	
0-200 psig (0-14 bar)*	A
0-150 psig (0-10 bar)	B
0-100 psig (0-6.9 bar)	C
0-50 psig (0-3.4 bar)	D
Reverse Flow 0-200 psig (0-14 bar)*	F
Reverse Flow 0-150 psig (0-10.3 bar)	G
Reverse Flow 0-100 psig (0-6.9 bar)	H
Reverse Flow 0-50 psig (0-3.4 bar)	J

*Must be ordered with metal bowl.

LOCKOUT VALVE	
L-O-X® on outlet side	1
L-O-X® on the inlet side (must also choose Reverse Flow)	2
L-O-X® with EEZ-ON® on outlet side	3
L-O-X® with EEZ-ON® on inlet side (must also choose Reverse Flow)	4
Without Valve - Leave Blank	

GAUGE	
Without Gauge	A
Gauge 0-200 psig (0-14 bar)	B
Gauge 0-60 psig (0-4 bar)	C
Without Gauge, with Panel Mount Nut	D
Gauge 0-200 psig (0-13 bar), with Panel Mount Nut	E
Gauge 0-60 psig (0-4 bar), with Panel Mount Nut	F

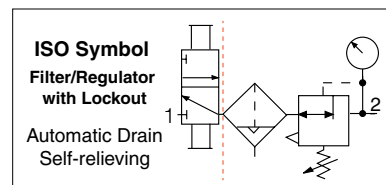

Bowl Type	Dimensions inches (mm)				Weight lb (kg)
	A	B*	C	Depth	
Polycarbonate	3.0 (76.2)	5.54 (140.6)	4.68 (119)	2.51 (63.8)	1.98 (0.90)
Metal	3.0 (76.2)	6.42 (163.1)	4.68 (119)	2.76 (70.1)	2.17 (0.99)

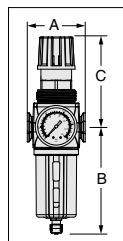

REPLACEMENT FILTER ELEMENTS		
Element Rating	Element Material	Model Number
5-µm - Standard	Polyethylene	R-A60F-03PE5
5-µm - Optional	Sintered Bronze	R-A60F-03E5
20-µm - Optional	Sintered Bronze	R-A60F-03E4
40-µm - Optional	Sintered Bronze	R-A60F-03E3

Lockout: With the lockout valve, add 2.3 (58) to dimension A.
 * Bowl (standard) removal clearance: add 3.1 (79)
 * Bowl (extended) removal clearance: add 6.1 (155)
 Dimensions above reflect less gauge.

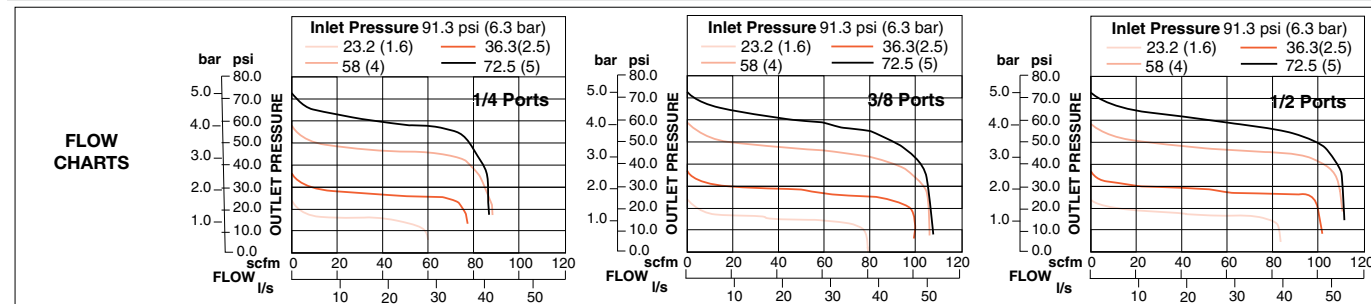

Options: External Bowl Drains, refer to page G6.7.
 Accessories ordered separately, refer to page G6.3-5.

STANDARD SPECIFICATIONS (for units on this page):

Construction Design	Filter – Sintered Regulator – Diaphragm	Pressure Gauge	0 to 200 psig (0 to 14 bar) or 0 to 60 psig (0 to 4 bar); 1/4-NPT gauge ports front and rear
Temperature	Ambient/Media: Polycarbonate Bowl: 40° to 125°F (4° to 52°C) Metal Bowl: 40° to 175°F (4° to 80°C)	Panel Mounting	2-1/16 inch (52 mm) hole required
Fluid Media	Compressed air	Filter Drain	Float drain or manual drain
Operating Pressure	Automatic Drain Models Polycarbonate Bowl: 30 to 150 psig (2 to 10 bar) Metal Bowl: 30 to 200 psig (2 to 14 bar) Manual Drain Models Polycarbonate Bowl: 0 to 150 psig (0 to 10 bar) Metal Bowl: 0 to 250 psig (0 to 17 bar)	Construction Material	Filter Element: 5-micron rated polyethylene, 5-, 20-, 40-micron rated sintered bronze Body: Zinc Bowl: Polycarbonate with nylon shatterguard, or aluminum bowl with clear nylon sight glass Dome: Nylon Seals: Nitrile Valve: Brass
Outlet Pressure	Adjustable up to 200 psig (14 bar)		
Pressure Adjustment	Locking Key: Removable		

Modular Integrated Filter/Regulators

FULL-SIZE Series

Port Sizes: 1/4, 3/8, 1/2 & 3/4 – Flow to 180 scfm



Port Size	Port Threads	Automatic Drain		Manual Drain	
		Polycarbonate Bowl	Metal Bowl	Polycarbonate Bowl	Metal Bowl
		Model Number	Model Number	Model Number	Model Number
1/4	NPTF	5321B2072	5322B2071	5321B2012	5322B2011
	G	C5321B2072	C5322B2071	C5321B2012	C5322B2011
3/8	NPTF	5321B3072	5322B3071	5321B3012	5322B3011
	G	C5321B3072	C5322B3071	C5321B3012	C5322B3011
1/2	NPTF	5321B4072	5322B4071	5321B4012	5322B4011
	G	C5321B4072	C5322B4071	C5321B4012	C5322B4011
3/4	NPTF	5321B5072	5322B5071	5321B5012	5322B5011
	G	C5321B5072	C5322B5071	C5321B5012	C5322B5011

Port Size	Bowl Type	Bowl Capacity	Dimensions inches (mm)				Weight † lb (kg)
			A	B**	C***	Depth †	
1/4, 3/8, 1/2, 3/4	Polycarbonate	8-oz (240-ml)	3.5 (89)	5.8 (146)	5.8 (146)	3.5 (89)	2.50 (1.15)
	Zinc	8-oz (240-ml)	3.5 (89)	6.4 (163)	5.8 (146)	3.5 (89)	2.55 (1.17)

** Bowl removal clearance: add 3.1 (79). *** Dome removal clearance: add 0.63 (16). † Less gauge.

ISO Symbol

Filter/Regulator

Automatic Drain
Self-relieving

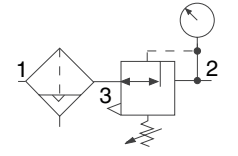

REPLACEMENT FILTER ELEMENTS		
Element Rating	Element Material	Model Number
5-µm - Standard	Polyethylene	939K77
5-µm - Optional	Sintered Bronze	R-KA103-03E5
20-µm - Optional	Sintered Bronze	R-KA103-03E4
40-µm - Optional	Sintered Bronze	R-KA103-03E3

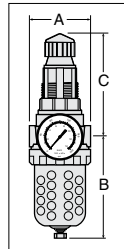

FLOW CHARTS

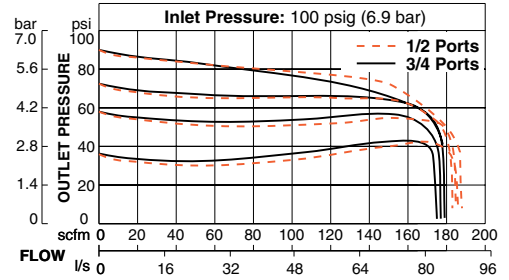
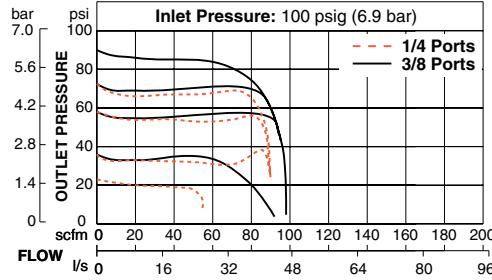

Pressure Gauge included.

Options: External Automatic Drain, refer to page G6.7.

Accessories ordered separately, refer to page G6.3-4.

STANDARD SPECIFICATIONS (for units on this page):

Construction Design	Filter – Fiber Regulator – Piston	Pressure Adjustment	Locking Key: Removable
Temperature	Ambient/Media:	Pressure Gauge	0 to 200 psig (0 to 14 bar); 1/4 NPT gauge ports front and rear
	Polycarbonate Bowl: 40° to 125°F (4° to 52°C) Metal Bowl: 40° to 175°F (4° to 80°C)	Panel Mounting	2-1/16 inch (52 mm) hole required
Fluid Media	Compressed air	Filter Drain	Automatic drain or manual drain
Operating Pressure	Automatic Drain Models	Construction Material	Filter Element: 5-micron rated polyethylene
	Polycarbonate Bowl: Up to 150 psig (up to 10 bar) Metal Bowl: Up to 200 psig (up to 14 bar)		Body: Zinc
Manual Drain Models	Bowl: Polycarbonate with steel shatterguard, or zinc bowl with clear nylon sight glass		
Polycarbonate Bowl: 0 to 150 psig (0 to 10 bar) Metal Bowl: 0 to 200 psig (0 to 14 bar)	Dome: Nylon		
Outlet Pressure	Adjustable up to 125 psig (9 bar).		Knob: Acetal
		Seals: Nitrile	

Port Sizes: 3/8, 1/2 & 3/4 – Flow to 230 scfm

Choose your options (in red) to configure your model number.

MD4 **53P** **B** **A** **B** **3** **B** **B** **1**

BOWL MATERIAL/SIZE	
Polycarbonate Bowl 9-oz (266-ml)	53P
Metal Bowl 9-oz (266-ml)	53M

BOWL DRAIN	
Auto Drain	A
Manual Drain	M

PIPE SIZE	
3/8 NPTF	3
1/2 NPTF	4
3/8 BSPP	C
1/2 BSPP	D
3/4 BSPP	E

GAUGE*	
Without Gauge	A
Gauge 0-200 psig (0-14 bar)	B
Gauge 0-60 psig (0-4 bar)	C
Without Gauge, with Panel Mount Nut	D
Gauge 0-200 psig (0-14 bar), with Panel Mount Nut	E
Gauge 0-60 psig (0-4 bar), with Panel Mount Nut	F

*1/4 NPT gauge ports front and rear.

LOCKOUT VALVE	
L-O-X® on outlet side	1
L-O-X® on the inlet side (must also choose Reverse Flow)	2
L-O-X® with EEZ-ON® on outlet side	3
L-O-X® with EEZ-ON® on inlet side (must also choose Reverse Flow)	4
Without Valve - Leave Blank	

FILTER ELEMENT TYPE	
40-µm Sintered Bronze	A
5-µm Polyethylene	B

ADJUSTMENT RANGE	
0-175 psig (0-12 bar)*	A
0-125 psig (0-8.6 bar)	B
0-50 psig (0-3.4 bar)	C
0-20 psig (0-1.4 bar)	D
Reverse Flow 0-175 psig (0-12 bar)*	F
Reverse Flow 0-125 psig (0-8.6 bar)	G
Reverse Flow 0-50 psig (0-3.4 bar)	H
Reverse Flow 0-20 psig (0-1.4 bar)	J

*Must be ordered with metal bowl.

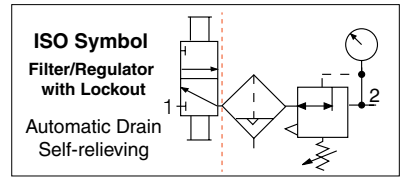

G3

Port Size	Bowl Type	Dimensions inches (mm)				Weight † lb (kg)
		A	B*	C**	Depth †	
3/8, 1/2, 3/4	Polycarbonate	3.5 (88)	7.7 (195)	5.4 (137)	2.9 (73)	3.69 (1.68)
	Aluminum	3.5 (88)	7.6 (193)	5.4 (137)	2.9 (73)	3.69 (1.68)

* Bowl removal clearance: add 3.1 (79).
** Dome removal clearance: add 0.63 (16). † Less gauge.

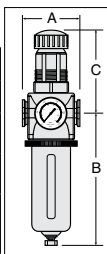

REPLACEMENT FILTER ELEMENTS*		
Element Rating	Element Material	Element Number
5-µm - Standard	Polyethylene	R-A115-106PE5
40-µm - Standard	Sintered Bronze	R-A115-106E3
5-µm - Optional	Sintered Bronze	R-A115-106E5
20-µm - Optional	Sintered Bronze	R-A115-106E4

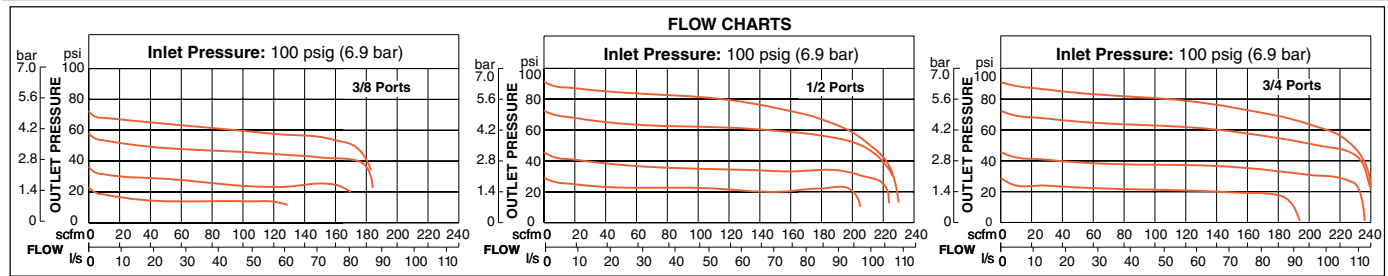

G

Options: External Bowl Drains, refer to page G6.7.
Accessories ordered separately, refer to page G6.3-5.

STANDARD SPECIFICATIONS (for units on this page):

Construction Design	Filter – Fiber Regulator – Piston	Pressure Gauge	0 to 200 psig (0 to 14 bar); 1/4 NPT gauge ports front and rear
Temperature	Ambient/Media: Polycarbonate Bowl: 40° to 125°F (4° to 52°C) Metal Bowl: 40° to 175°F (4° to 80°C)	Panel Mounting	2.05 inch (52.1 mm) hole required
Fluid Media	Compressed air	Filter Drain	Automatic or manual
Operating Pressure	Automatic Drain Models Polycarbonate Bowl: Up to 150 psig (up to 10 bar) Metal Bowl: Up to 200 psig (up to 14 bar) Manual Drain Models Polycarbonate Bowl: 0 to 150 psig (0 to 10 bar) Metal Bowl: 0 to 200 psig (0 to 14 bar)	Construction Material	Filter Element: 5-micron rated polyethylene, or 40-micron rated sintered bronze Body: Zinc Bowl: Polycarbonate with steel shatterguard, or aluminum bowl with clear nylon sight glass Bonnet: Nylon; aluminum with optional 0 to 175 psig (0 to 12 bar) spring Cap Color: Black Seals: Nitrile Valve: Brass
Outlet Pressure	Adjustable up to 125 psig (9 bar).		
Pressure Adjustment	Locking Key: Removable		

Stainless Steel Integrated Filter/Regulators with Lockout L-O-X® Valves

Series 15

Port Sizes: 1/4, 1/2, 3/4 & 1 – Flow to 17 scfm

Port Size		Model Number	C _v	
1-2	3		1-2	2-3
1/4	1/4	RC010-13	2.14	2.08
1/2	1/2	RC011-13	4.4	6.24
3/4	1	RC012-13	5.0	17.0
1	1	RC013-13	8.0	17.0

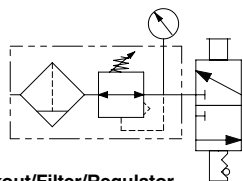

Lockout/Filter/Regulator
ISO Symbol
Lockout, Manual Drain, Self-relieving

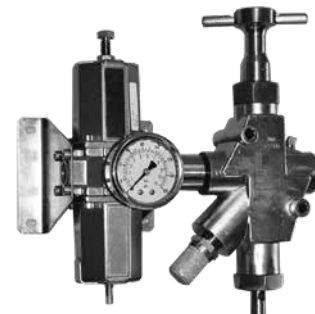

Port Size		Avg. C _v		Dimensions (inches/mm)		
1-2	3	1-2	2-3	Length	Width	Depth
1/4	1/4	2.14	2.08	8.9 (226.1)	7.65 (194.4)	5.86 (149)
1/2	1/2	4.4	6.24	10.24 (260)	8.98 (228)	5.94 (151)
3/4	1	5.0	17.0	15.75 (400)	12.24 (311)	6.49 (165)
1	1	8.0	17.0	15.75 (400)	12.24 (311)	6.49 (165)

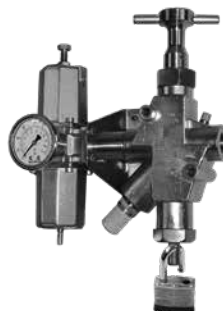

G3

ACCESSORIES

Stainless Steel Pressure Switch

Inlet Port Size	Model Number	Weight lb (kg)
1/8	1162A30	0.23 (.01)

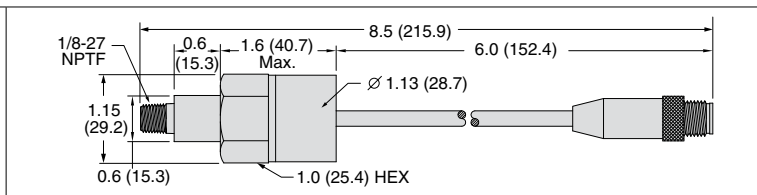
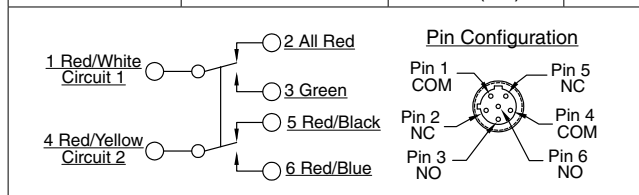

Stainless Steel Visual Indicator

Inlet Port Size	Model Number	Weight lb (kg)
1/8	1155H30	0.22 (0.1)

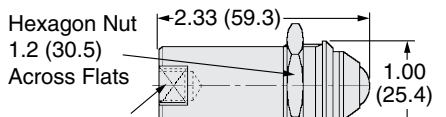

G

* NPT threads. For G threads, consult ROSS.

STANDARD SPECIFICATIONS (for units on this page):

Construction Design	Poppet, 316 Stainless Steel	Operating Pressure	0 to 300 psig (0 to 21 bar)
Mounting Type	In-line		Secondary Pressure: 7 to 174 psig (0.5 to 12 bar)
Temperature	Ambient/Media: 30° to 175°F (-1° to 80°C) <i>Note: For lower temperature ratings, consult ROSS.</i>	Construction Material	Seals: Fluorocarbon (Viton)
Flow Media	Filtered air	Lock Hole Diameter	Port sizes 1/4 thru 2: 0.34 inch (8.64 mm)
		Length of Hole	Port sizes 1/4: 0.44 in (11.17 mm) Port sizes 1/2: 0.47 in (11.93 mm)

Mounting Screws for BANTAM Models

Usage Models	Kit Number
BANTAM	859K77

BANTAM models mounts with long screws that extend through end plates.

Mounting Brackets for Regulators and Integrated Filter/Regulators

Regulators and integrated filter/regulators can be mounted to a surface with a bracket that attaches to the regulator. Brackets and mounting panel nuts can be ordered separately or in a kit which includes both bracket and mounting panel nut.

Usage Models	Model Number			Dimensions inches (mm)					Panel Mounting Hole Diameter
	Kit	Bracket	Panel Nut	A	B	C	D	E	
MINIATURE	873K77	872K77	874K77	1.375 (35)	1.125 (29)	0.31 (8)	0.31 (8)	0.69 (17)	1.19 (30)
MID-SIZE	876K77	875K77	877K77	2.38 (60)	1.00 (25)	1.50 (38)	-	-	1.56 (40)
MD3™	R-A127-11	-	R-127-11	2.38 (60)	1.00 (25)	1.50 (38)	-	-	2.06 (52)
FULL-SIZE, MD4™	879K77	878K77	880K77						

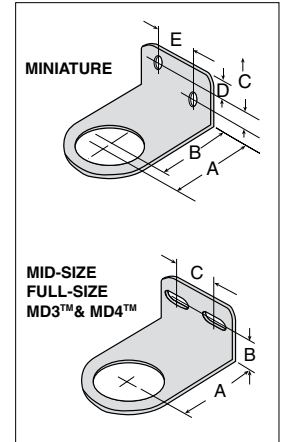

Modular Mounting Brackets for Filters, Regulators, Lubricators, FRL's, or Clean Air Packages

Two L-shaped metal brackets as shown at the right can be used for wall mounting of modular FRLs or Clean Air Packages. A single bracket can be used to mount individual filters or lubricators. Kits include two brackets and four screws for attaching the brackets to the modules.

Usage Models	Kit Number	Dimensions inches (mm)			
		A	B	C	D
MID-SIZE & FULL-SIZE	915K77	3.0 (76)	0.88 (22)	1.00 (25)	1.20 (31)

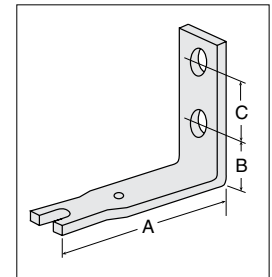

FRLs In-line Mounting Pipe Brackets

Two pipe brackets can be used for wall mounting of FRLs assemblies that use pipe nipples to join the components. The bracket kits listed below include two sets of brackets.

Nipple Size	Kit Number	Dimensions inches (mm)		
		A	B	C
1/4	887K77	2.72 (28)	0.50 (13)	1.00 (25)
3/8	888K77			
1/2	889K77			
3/4	890K77	3.69 (94)	1.13 (29)	1.25 (32)
1	891K77			

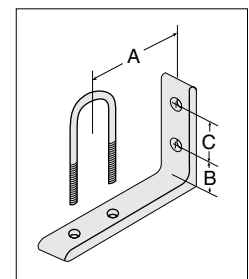

Bracket Assembly Kit for HIGH-RELIEF Pilot Operated Regulator

High-Relief Pilot Operated Regulator with 1/4- thru 1 1/4 inch ports can be mounted to a vertical surface using a bracket assembly kit.

Kit Number
R-A37-381



MID-SIZE and FULL-SIZE Units

The modular designs of the MID-SIZE and FULL-SIZE series offer maximum flexibility in customizing FRLs assemblies. As shown at the right, connector kits are required to interconnect units. Various port kits (shown below) can be used to connect the assemblies to the inlet and outlet piping. Note that all FRLs components have threaded ports so that conventional pipe fittings may be used where desired.

Female Port Block

Used to connect to piping at inlet or outlet.

Port Size	Model Number	
	NPTF Threads	G Threads
1/4	897K77	D897K77
3/8	898K77	D898K77
1/2	899K77	D899K77
3/4	900K77	D900K77



Male Port Block

Used to connect modular to non-modular units.

Port Size	Model Number	
	NPTF Threads	G Threads
1/4	893K77	D893K77
3/8	894K77	D894K77
1/2	895K77	D895K77
3/4	896K77	D896K77



Connector Kit

Used to connect units to one another as well as to any of the ports shown on this page.

Kit Number	892K77
------------	--------

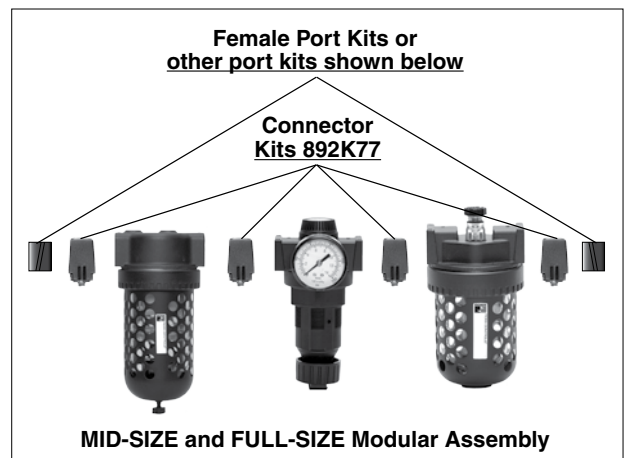

BANTAM Units

BANTAM modular units use end plates secured with screws to hold the pipe or tubing ports (see below), and also to serve as mounting brackets. Short screws are used to secure the end plates when a single BANTAM unit is used. If two or more units are combined, long screws extend through an end plate and thread into the next unit.

Screw kits required are as follows:

Single Unit: Two short screw kits.

Two-Unit Combination: One each short screw kit and long screw kit.

Three-Unit Combination: Two long screw kits.

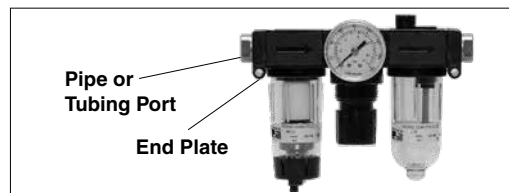

Pipe Ports	
Port Size	Model Number
1/8 NPTF	862K77
1/4 NPTF	863K77
1/8 BSPP	D864K77
1/4 BSPP	D865K77

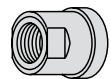

Pipe Ports	
Kit Description	Model Number
END PLATE (1)	857K77
Short Screw (2)	858K77
Long Screw (2)	859K77
Small O-Ring (for inlet or mating ports)	860K77
Large O-Ring (for outlet or mating ports)	861K77

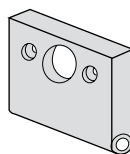

Tube Ports	
Port Size	Model Number
1/4	866K77
3/8	867K77
4 mm	868K77
6 mm	869K77
8 mm	870K77
10 mm	871K77

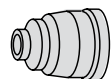

Modular Assemblies

Accessories: Clamp, Brackets, End Ports & Port Blocks

MD Series

Dimensions: inches (mm)

MD3™ Series

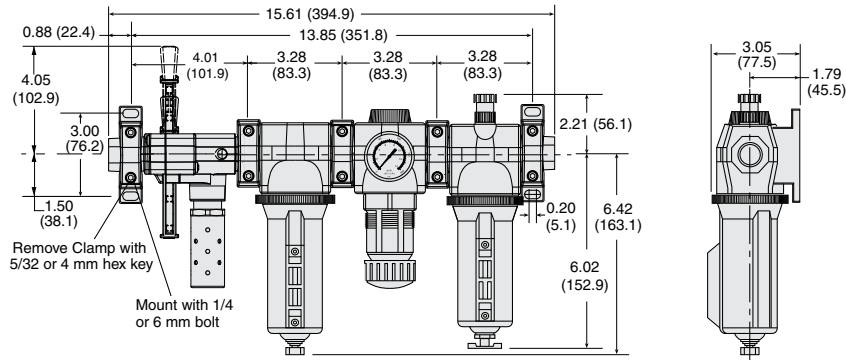

MD4™ Series

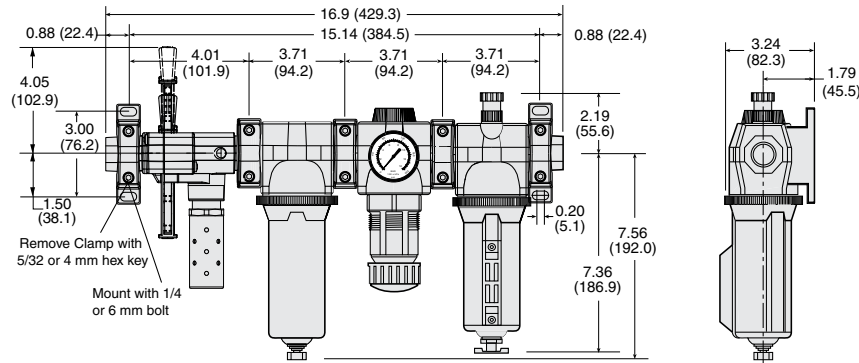

Mounting Brackets & Clamp for Module Connections

Two brackets are normally used to mount an FRL to a vertical surface. The mounting bracket attaches to the module connecting clamp (see above) with a single screw. Each bracket then employs two bolts (1/4" or 6mm) to connect the assembly to the mounting surface. Specially designed clamps provide a quick and easy assembly or disassembly of MD3™ modules. Two Allen-Head bolts quickly tighten or loosen the clamp using a 5/32 or 4mm hex key. The clamp contains a plate carrying two O-rings to provide positive sealing between modules.



Bracket, Screw, and Clamp



Module Connecting Clamp



Mounting Bracket

Mounting Brackets & Clamp for Module Connections

Description	Model Number
Bracket and Screw	R-A118-103
Module Connecting Clamp	R-A118-105
Bracket, Screw, and Clamp	R-A118-105M

Male and Female End Ports

Either male or female end ports can be attached to threaded inlet and outlet lines. This allows all modules of an FRL assembly to be removed easily and quickly without having to unthread the end modules. The end ports are attached to the modules with clamps (see at left). End ports can be included in an assembled FRL or ordered separately by the following model numbers:

End Ports				
Type	Port Size	Model Number		
		NPTF Threads	G Threads	
Female	1/4	R-118-100-2	R-118-100-2W	
	3/8	R-118-100-3	R-118-100-3W	
	1/2	R-118-100-4	R-118-100-4W	
	3/4	R-118-100-6	R-118-100-6W	
Male	1/4	R-118-109-2F	R-118-109-2FW	
	3/8	R-118-109-3F	R-118-109-3FW	
	1/2	R-118-109-4F	R-118-109-4FW	
	3/4	R-118-109-6F	R-118-109-6FW	

Extra Port Blocks

An extra port block can be placed between modules to provide two auxiliary 1/4 NPTF ports. Its mounting position can be rotated to obtain the most convenient operating orientation. If only one auxiliary port is to be used, the unused port must be closed with a pipe plug. (The inlet and outlet are not threaded.)

Port Size	Model Number	
	NPTF Threads	G Threads
1/4	R-118-106-2	R-118-106-2W
3/8	R-118-106-3	R-118-106-3W
1/2	R-118-106-4	R-118-106-4W





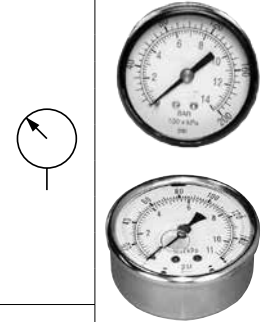

Analog Pressure Gauges

Pressure Gauges (Center Back Mounting)	Type/Material	Port Size	Model Number		Pressure Range psig (bar)	Case Diameter inches (mm)
			Thread			
			NPT	G		
Standard Aluminum		1/8	5400A1002	D5400A1002	0-160 (0-11)	1.7 (43)
		1/4	5400A2010	D5400A2010	0-60 (0-4)	2.0 (51)
		1/4	5400A2011	D5400A2011	0-200 (0-14)	2.0 (51)
		1/4	5400A2012	D5400A2012	0-300 (0-20)	2.0 (51)
Liquid Filled Stainless Steel		1/4	5400A2014	D5400A2014	0-160 (0-11)	2.5 (64)
		1/4	5400A2015*	D5400A2015*	0-160 (0-11)	2.0 (51)

*Green shade between 40-70 psi (2.7-4.8 bar).



Differential Pressure Gauges

DIFFERENTIAL PRESSURE GAUGE TYPE/SERIES	Small Slide Gauge	Small Slide Gauge	Large Dual Face Gauge	Large Dual Face Gauge with Reed Switch (Normally Open)	Large Dual Face Gauge with Reed Switch (Normally Closed)
	R-A60F-28	R-K103-151	R-106-35	R-106-35E	R-106-35EC
					
FILTERS					
BANTAM	-	-	-	-	-
MINIATURE	-	-	-	-	-
MID-SIZE	-	-	-	-	-
MD3™		-	-	-	-
FULL-SIZE	-	-	-	-	-
MD4™	-				
HIGH-CAPACITY	-	-	-	-	-
COALESCING FILTERS					
BANTAM	-	-	-	-	-
MINIATURE	-	-	-	-	-
MID-SIZE		-	-	-	-
FULL-SIZE	-				
MD3™		-	-	-	-
MD4™	-				
HIGH-CAPACITY	-				
OIL VAPOR REMOVAL (ADSORBING) FILTERS					
MD3™	-	-	-	-	-
MD4™	-	-	-	-	-
CLEAN AIR PACKAGES					
MD3™		-	-	-	-
MD4™	-				

External Automatic Drains

Pipe Size	Model Number*	
	Polycarbonate Bowl**	Metal Bowl
1/8	5057B1001	5058B1001
1/4*	5057B2001	5058B2001

*Use 1/4 size with FULL-SIZE, HIGH-CAPACITY, MD3™ & MD4™ filters.
Use kit 1076K77 to convert standard bowl to accept auto drain unit.
**Available for FULL-SIZE filters only. Polycarbonate bowl includes metal bowl guard.

Port Size	Dimensions inches (mm)			Weight lb (kg)
	A	B	C	
1/8, 1/4	3.5 (89)	4.2 (107)	8.3 (211)	2.6 (1.2)

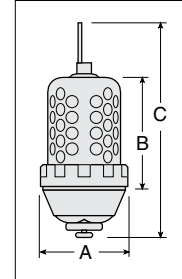

Electronically Controlled Drain

Pipe Size	Voltage	Model Number	
		NPTF Threads	G Threads
1/4	24 volts DC	R-DED-24V-2	R-DED-24V-2W
3/8	24 volts DC	R-DED-24V-3	R-DED-24V-3W
1/2	24 volts DC	R-DED-24V-4	R-DED-24V-4W
1/4	110-120 volts AC, 50/60 Hz	R-DED-115V-2	R-DED-115V-2W
3/8	110-120 volts AC, 50/60 Hz	R-DED-115V-3	R-DED-115V-3W
1/2	110-120 volts AC, 50/60 Hz	R-DED-115V-4	R-DED-115V-4W

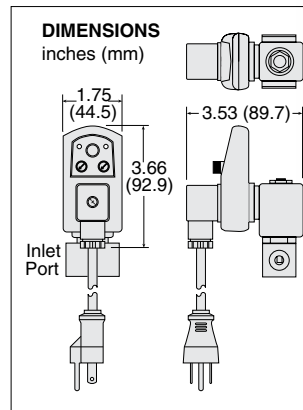

STANDARD SPECIFICATIONS (for electronically controlled drain):

Drain Time	Adjustable 0.5 to 10 seconds	Electrical Connection	DIN 43650A, ISO 440/6952
Drain Interval	0.5 to 45 minutes	Valve Type	2/2 direct acting, normally closed
Current Consumption	Maximum 4 ma	Valve Body	Forged brass; 3/16-inch (4.8 mm) orifice
Temperature	Ambient: 35° to 130°F (2° to 54°C)	Maximum Pressure	230 psig (15.8 bar)
	Media: 35° to 190°F (2° to 88°C)		

Silencers

Port Size	Thread Type	Model Number*		Avg. C _v	Dimensions inches (mm)		Weight lb (kg)
		NPT Threads	R/Rp Threads		Width	Length	
3/8	Male	5500A3003	D5500A3003	4.3	1.3 (32)	3.5 (88)	0.2 (0.1)
3/4	Male	5500A5013	D5500A5013	5.1	1.3 (32)	3.6 (92)	0.2 (0.1)
3/4	Male	5500A5003	D5500A5003	11.5	2.0 (51)	5.3 (135)	0.6 (0.3)

Flow Media: Filtered air.
Pressure Range: 0 to 290 psig (0 to 20 bar) maximum.

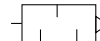

Replacements Filter Elements

FRL's Series

Category	Series	Bowl Type	Element Rating	Element Material	Model Number
Filters	Bantam & Miniature	Standard	5-µm	Polyethylene	933K77
			5-µm	Sintered Bronze	R-KA130-27E5
			20-µm	Sintered Bronze	R-KA130-27E4
			40-µm	Sintered Bronze	R-KA130-27E3
	MID-SIZE	Standard	5-µm	Polyethylene	936K77
	MD3™	Standard	5-µm	Polyethylene	R-A60F-03PE5
			5-µm	Sintered Bronze	R-A60F-03E5
			20-µm	Sintered Bronze	R-A60F-03E4
			40-µm	Sintered Bronze	R-A60F-03E3
	FULL-SIZE	Standard	5-µm	Polyethylene	939K77
			5-µm	Sintered Bronze	R-KA103-03E5
			20-µm	Sintered Bronze	R-KA103-03E4
			40-µm	Sintered Bronze	R-KA103-03E3
	MD4™	Standard	5-µm	Polyethylene	R-A115-106PE5
			5-µm	Sintered Bronze	R-A115-106E5
			20-µm	Sintered Bronze	R-A115-106E4
			40-µm	Polyethylene	R-A115-106PE3
	HIGH-CAPACITY Flow to 275 scfm	Standard	5-µm	Polyethylene	1010K77
			5-µm	Sintered Bronze	R-KA109-03E5
			20-µm	Sintered Bronze	R-KA109-03E4
40-µm			Sintered Bronze	R-KA109-03E3	
HIGH-CAPACITY Flow to 660 scfm	Standard	5-µm	Sintered Bronze	1656K77	
		40-µm	Sintered Bronze	R-A114-106E3	
HIGH-CAPACITY Flow to 1000 scfm	Standard	5-µm	Sintered Bronze	942K77	
		40-µm	Sintered Bronze	944K77	
Coalescing Filters	Bantam & Miniature	Standard	0.3-µm	Borosilicate-glass-fiber	945K77
			0.01-µm	Borosilicate-glass-fiber	R-A-10F-16E8
	MID-SIZE	Standard	0.3-µm	Borosilicate-glass-fiber	R-A60F-29
			0.01-µm	Borosilicate-glass-fiber	R-A60F-32
		Extended	0.01-µm	Borosilicate-glass-fiber	R-A60F-29E8
			0.01-µm	Borosilicate-glass-fiber	R-A60F-32E8
	MD3™	Polycarbonate	0.3-µm	Borosilicate-glass-fiber	R-A60F-23
			0.3-µm	Borosilicate-glass-fiber	R-A60F-29
		Extended Metal	0.3-µm	Borosilicate-glass-fiber	R-A60F-32
			0.01-µm	Borosilicate-glass-fiber	R-A60F-23E8
		Metal	0.01-µm	Borosilicate-glass-fiber	R-A60F-29E8
			0.01-µm	Borosilicate-glass-fiber	R-A60F-32E8
	FULL-SIZE	Standard	0.3-µm	Borosilicate-glass-fiber	947K77
			0.3-µm	Borosilicate-glass-fiber	R-A103-160L
		Extended	0.01-µm	Borosilicate-glass-fiber	948K77
			0.01-µm	Borosilicate-glass-fiber	R-A103-160LE8
	MD4™	Standard	0.3-µm	Borosilicate-glass-fiber	R-A115-117
			0.3-µm	Borosilicate-glass-fiber	R-A115-118
		Extended	0.01-µm	Borosilicate-glass-fiber	R-A115-117E8
			0.01-µm	Borosilicate-glass-fiber	R-A115-118E8
	HIGH-CAPACITY Flow to 220 scfm	Standard	0.3-µm	Borosilicate-glass-fiber	949K77
			0.01-µm	Borosilicate-glass-fiber	R-A109-106E8
	HIGH-CAPACITY Flow to 295 & 450 scfm	Standard	0.3-µm	Borosilicate-glass-fiber	R-A114-112
			0.3-µm	Borosilicate-glass-fiber	R-A114-113
		Extended	0.01-µm	Borosilicate-glass-fiber	R-A114-112E8
			0.01-µm	Borosilicate-glass-fiber	R-A114-113E8
	HIGH-CAPACITY Flow to 465 scfm	Standard	0.3-µm	Borosilicate-glass-fiber	952K77
			0.3-µm	Borosilicate-glass-fiber	953K77
		Extended	0.01-µm	Borosilicate-glass-fiber	R-A106-24E8
			0.01-µm	Borosilicate-glass-fiber	R-A106-24LE8
HIGH-CAPACITY Flow to 840 scfm	Extended	0.3-µm	Borosilicate-glass-fiber	953K77	
		0.01-µm	Borosilicate-glass-fiber	R-A106-24E8	
Oil Vapor Removal Filters	MD3™	Standard	–	Borosilicate-glass-fiber	R-A60F-29E9
		Extended	–	Borosilicate-glass-fiber	R-A60F-32E9
	MD4™	Standard	–	Borosilicate-glass-fiber	R-A115-117E9
		Extended	–	Borosilicate-glass-fiber	R-A115-118E9
Silencers Reclassifiers	Port Size 1/2	Standard	20-µm	Sintered Bronze	940K77
	Port Size 3/4, 1		100-µm	Sintered Bronze	981K77